

Capital Regional District

Core Area Wastewater Treatment Assessment of Wastewater Treatment Options 1A, 1B and 1C

Volume 1 - Report



Prepared by:
Stantec Consulting Ltd. | Brown and Caldwell



September 16, 2009

BROWN AND
CALDWELL

Capital Regional District

Core Area Wastewater Treatment Program

Assessment of Wastewater Treatment

Options 1A, 1B and 1C



Stantec

BROWN AND
CALDWELL

This report was prepared by Stantec Consulting Ltd. | Brown and Caldwell for the Capital Regional District. The material in it reflects our best judgment in light of the information available to us at the time of preparation. Any use which a third party makes of this report, or any release of or decisions made based on it, are the responsibilities of such third parties. Stantec Consulting Ltd. | Brown and Caldwell accepts no responsibility for damages, if any, suffered by any third party as a result of decisions made or actions taken based on this report.

Table of Contents

Volume 1 Report

Executive Summary	1
E.1 Background.....	1
E.2 Facility Siting.....	3
E.2.1 Design Criteria for New Facilities.....	5
E.2.2 Liquid Train Treatment Design for Options 1A, 1B and 1C.....	5
E.2.3 Biosolids Design for Options 1A, 1B and 1C	6
E.2.4 Conveyance Systems.....	6
E.2.5 Resources from Wastewater	7
E.2.6 Carbon Footprint.....	8
E.2.7 Opinion of Probable Costs.....	8
E.2.8 Triple Bottom Line Analysis of Options.....	9
E.2.9 Risk Assessment.....	11
E.2.10 Discussion of Analysis and Recommendation.....	11
Section 1 Introduction	14
1.1 Background.....	14
1.2 Previous Work and Reference Materials.....	14
1.3 Findings of the Peer Review Report	15
1.4 CRD Goals and Objective for the Core Area Wastewater Treatment Program	16
1.5 CALWMC Motions.....	16
1.6 Description of Options 1A, 1B and 1C	16
1.6.1 Option 1A.....	16
1.6.2 Option 1B.....	17
1.6.3 Option 1C	18
1.7 Facility Siting.....	19
Section 2 Design Criteria for New Facilities	22
2.1 Catchment Areas	22
2.2 Current Liquid-Train Regulatory Requirements	22
2.2.1 Provincial Regulation.....	23
2.2.2 Federal Initiatives.....	23
2.3 Flexibility for Potential Future Regulatory Changes.....	25
2.4 Biosolids Regulatory Requirements.....	26
2.5 Odour Control.....	27
2.6 Wastewater Characteristics	27

2.7	2030 and 2065 Design Flow	27
2.7.1	Option 1A Design Flows.....	28
2.7.2	Option 1B Design Flows.....	31
2.7.3	Option 1C Design Flows.....	34
2.7.4	Modified Option 1A – Option 1A ¹	36
2.8	2030 and 2065 Design Loads.....	36
2.8.1	Option 1A Design Loads.....	37
2.8.2	Option 1B Design Loads.....	40
2.8.3	Option 1C Design Loads.....	42
Section 3 Liquid Train Design for Option 1A, 1B and 1C		43
3.1	General	43
3.2	Representative Secondary Treatment Technologies.....	44
3.3	Option 1A Liquid Train Treatment.....	46
3.3.1	Saanich East - North Oak Bay MBR.....	46
3.3.2	Clover Point Wet Weather Treatment.....	47
3.3.3	Biological Aerated Filter.....	48
3.3.4	MBR Option.....	48
3.4	Option 1B - Liquid Train Treatment.....	49
3.5	Option 1C - Liquid Train Treatment.....	49
Section 4 Biosolids Design for Options 1A, 1B, 1C		51
4.1	Representative Biosolids Treatment Technology.....	51
4.2	Integration of Biosolids and Solid Wastes.....	52
4.3	Site Constraints.....	53
4.4	Biosolids Facilities Design Criteria.....	54
4.5	Regional Energy Centre (Biosolids) Facility.....	54
4.6	Resource Recovery from Solids Processing.....	54
4.7	Description of Solids Treatment for Option 1A.....	55
4.8	Description of Solids Treatment for Option 1B.....	55
4.9	Description of Solids Treatment for Option 1C.....	55
Section 5 Conveyance Systems.....		56
5.1	Description of Existing Conveyance System.....	56
5.1.1	Clover Point Pump Station and Outfall	56
5.1.2	Macaulay Point Pump Station and Outfall	56
5.2	Conveyance System Upgrading Requirements.....	57
5.2.1	Upgrades Required for All Options.....	57
5.2.2	Site Investigations.....	58
5.3	Option 1A - Conveyance System.....	59
5.3.1	Saanich East - North Oak Bay WWTP.....	59
5.3.2	Clover Point WWTP and Pump Station	59

5.3.3	Macaulay and McLoughlin Point WWTP	59
5.3.4	West Shore WWTP	60
5.4	Option 1B - Conveyance System.....	60
5.4.1	Saanich East - North Oak Bay WWTP.....	60
5.4.2	Clover Point WWTP and Pump Station	60
5.4.3	Macaulay Point WWTP and Pump Station	60
5.4.4	West Shore WWTP.....	60
5.5	Option 1C - Conveyance System.....	61
5.5.1	Saanich East - North Oak Bay WWTP.....	61
5.5.2	Clover Point Pump Station.....	61
5.5.3	Macaulay Point Pump Station.....	61
5.5.4	West Shore WWTP.....	61
5.6	Marine Pipeline Crossing.....	62
5.7	Outfalls.....	62
5.8	Tunnel Design Concepts.....	63
5.9	Pumping Facilities.....	64
5.9.1	Saanich East - North Oak Bay Pump Station	64
5.9.2	Clover Point Pump Station.....	65
5.9.3	Macaulay Pump Station.....	66
5.9.4	Pump Station Control.....	68
5.10	Sludge Conveyance.....	68
Section 6 Resources from Wastewater		70
6.1	Water Reuse.....	70
6.1.1	Option 1A – Water Reuse Potential.....	71
6.1.2	Options 1B and 1C	71
6.2	Heat Recovery	72
6.2.1	Saanich East - North Oak Bay Plant.....	73
6.2.2	McLoughlin Plant.....	73
6.2.3	West Shore Plant.....	73
6.2.4	Key Performance Indicator Summary.....	74
6.2.5	Further Work.....	74
6.2.6	Seawater Based Heat Source	75
6.3	Gas Recovery	75
6.4	Phosphorus Recovery.....	76
6.5	Biosolids Resources.....	76
6.5.1	Dried Fuel Product.....	77
6.5.2	Top Soil Amendment.....	77
6.5.3	Willow Coppice.....	77
6.5.4	Biocell.....	78
6.6	Regional Energy Centre.....	78

Section 7 Carbon Footprint Analysis	81
7.1 Basis of Methodology.....	82
7.2 Carbon Footprint Impact	86
7.3 Recovery of Saleable Products & Greenhouse Gas Offsets.....	88
7.4 Solar Energy	89
Section 8 Basis of Opinion of Probable Capital Costs	90
8.1 Cost Basis.....	90
8.2 Capital Costs.....	90
8.3 Operations and Maintenance Costs.....	91
8.4 Life Cycle Costs.....	91
Section 9 Triple Bottom Line Analysis Framework	92
9.1 Triple Bottom Line Methodology	92
9.2 Placing Value on Factors.....	95
9.2.1 Economic Impacts	96
9.2.2 Environmental Impacts.....	98
9.2.3 Social Impacts.....	103
9.3 Alternative Evaluation	108
Section 10 Risk Assessment of Option 1A, 1B, 1C.....	111
10.1 Methodology.....	111
10.2 Risk Matrix	111
10.3 Risk Ranking.....	111
Section 11 Discussion of Analysis and Recommendation	119
11.1 Summary of Siting Investigations.....	119
11.2 Siting of Biosolids Facilities.....	120
11.3 Wet Weather Treatment Facilities.....	120
11.4 Resource Recovery & Carbon Footprint.....	121
11.5 Triple Bottom Line Assessment	121
11.6 Recommendation.....	121

Appendix A – Triple Bottom Line Analysis

Volume II Drawings (Under Separate Cover)

Executive Summary

Executive Summary

E.1 Background

The CRD is currently in the process of planning wastewater treatment facilities for the Core Area of Greater Victoria. A Peer Review Team was engaged to review previous planning work and suggested that three additional options, referred to as Option 1A, 1B and 1C in this report, be investigated further using a triple bottom line analysis. **Tables E.1 through E.3** describe the facilities that are part of each option. They are shown in **Figures E.1 through E.3**.

Table E.1
Major Facilities to be Constructed Under Option 1 A

Location	Description of Facility
Saanich East - North Oak Bay	New secondary plant, new outfall parallel to existing outfall, collection system modifications, influent pumping station, solids discharged to collection system.
Clover Point	Wet weather treatment for 2 - 4 x ADWF, pump station and forcemain to McLoughlin Point to transfer flows up to 2 X ADWF for secondary treatment. Screening for all flows above 4 X ADWF. Wet weather treatment plant could be deferred or eliminated pending discussions with Provincial and Federal regulators.
McLoughlin Point	Secondary treatment plant to treat flows from Macaulay and Clover catchments up to 2 x ADWF. Primary treatment for all flows up to 4 X ADWF. Pump station at Macaulay to convey flows to McLoughlin for treatment.
Upper Victoria Harbour	Regional biosolids treatment facility to treat biosolids from the McLoughlin Point plant.
Macaulay Point	Pump Station to convey flows to McLoughlin Point. Macaulay wet weather flows are treated at McLoughlin. Screening for all flows above 4 x ADWF.
West Shore Plant	New Secondary Treatment Plant and integrated biosolids treatment facility serving only West Shore communities.
Conveyance Facilities	Forcemain to transfer flows from Clover Point to Macaulay. Tunnel or forcemain to transfer flows to McLoughlin.
Outfalls	New Outfalls at Saanich East - North Oak Bay, Macaulay and West Shore.
Resource Recovery	Water reuse facilities built into plant designs at Saanich East - North Oak Bay, McLoughlin and West Shore. Heat recovery from effluent built into Saanich East - North Oak Bay, McLoughlin and West Shore Plants. Biosolids resource recovery including co-digestion, production of soil amendment, recovery and sale of biogas, sludge drying and phosphorus recovery.



WEST SHORE WWTP				
Capacity	Present	2030	2065	Ultimate
Screening	96.60	153.36		
Pumping				
Primary	96.40	153.36		
Secondary (ML/d)		48.20	76.68	
Biosolids (Kg/d)		7570	12040	
ADWF (TRIB) (ML/d)		24.14	38.34	

MACAULAY/McLOUGHLIN WWTP				
Capacity	Present	2030	2065	Ultimate
Screening	435	435	435	
Pumping	261.01	275.83		
Primary	261.01	275.83		
Secondary (ML/d)		169.40	174.90	
Biosolids (Kg/d)		29300	30500	
ADWF (TRIB) (ML/d)		46.40	50.40	
ADWF (T) (ML/d)		84.15	87.48	

EAST SAANICH WWTP				
Capacity	Present	2030	2065	Ultimate
Screening		66.42	68.71	
Pumping				
Primary		66.42	68.71	
Secondary (ML/d)		29.05	30.05	
Biosolids (Kg/d)		5220	5410	
ADWF (ML/d)		16.80	17.17	

CLOVER POINT WET WEATHER WWTP AND PS				
Capacity	Present	2030	2065	Ultimate
Screening		403	403	
Pumping		75.80	74.10	
Primary		75.80	74.10	
ADWF (ML/d)		37.80	37.10	



CAPITAL REGIONAL DISTRICT
 CORE AREA WASTEWATER TREATMENT PROGRAM
 OPTION 1A

DESIGNED	DRAWN	SCALE	CHECKED	APPROVED	DATE	CONTRACT NO.	DWG. NO.	REV.	SHT
RAF	PC	N.T.S.	-	-	12/08/09	-	FIG. E.1	-	1 OF 1



WEST SHORE WWTP				
Capacity	Present	2030	2065	Ultimate
Screening		96,60	153,40	
Pumping				
Primary (ML/d)		284,20	328,32	
Secondary (ML/d)		218,00	251,50	
Biosolids (Kg/d)		37000	42500	
ADWF (TRIB) (ML/d)		24,14	38,34	
ADWF (T) (ML/d)		284,87	328,32	

MACAULAY WET WEATHER WWTP AND PS				
Capacity	Present	2030	2065	Ultimate
Screening		435	435	
Pumping		168,29	174,96	
Primary (ML/d)		92,80	100,86	
Secondary (ML/d)				
ADWF (TRIB) (ML/d)		46,40	50,40	
ADWF (T) (ML/d)		84,15	87,48	

EAST SAANICH WWTP				
Capacity	Present	2030	2065	Ultimate
Screening		66,42	66,71	
Pumping				
Primary (ML/d)		66,42	68,71	
Secondary (ML/d)		29,05	30,05	
Biosolids (Kg/d)		5220	5410	
ADWF (ML/d)		16,60	17,17	

CLOVER POINT WET WEATHER WWTP AND PS				
Capacity	Present	2030	2065	Ultimate
Screening		403	403	
Pumping		75,60	74,20	
Primary (ML/d)		75,60	74,20	
ADWF (ML/d)		37,80	37,10	



CAPITAL REGIONAL DISTRICT
 CORE AREA WASTEWATER TREATMENT PROGRAM
 WEST SHORE 2X ADFW SECONDARY
 OPTION 1B

DESIGNED	DRAWN	SCALE	CHECKED	APPROVED	DATE	CONTRACT NO.	DWG. NO.	REV.	SHT OF
RAF	PC	NTS	-	-	12/08/09	-	FIG. E.2	-	1 OF 1



WEST SHORE WWTP				
Capacity	Present	2030	2065	Ultimate
Screening		98,80	153,40	
Pumping				
Primary		433,20	503,29	
Secondary (ML/d)		216,80	251,50	
Biosolids (Kg/d)		37000	42500	
ADWF (TRIB) (ML/d)		24,14	38,34	
ADWF (T) (ML/d)		433,16	503,29	

MACAULAY PS				
Capacity	Present	2030	2065	Ultimate
Screening		435	435	
Pumping		336,80	350,00	
Primary				
Secondary (ML/d)				
ADWF (TRIB) (ML/d)		46,40	50,40	
ADWF (T) (ML/d)		84,15	87,48	

EAST SAANICH WWTP				
Capacity	Present	2030	2065	Ultimate
Screening		66,42	68,71	
Pumping				
Primary		66,42	68,71	
Secondary (ML/d)		29,06	30,05	
Biosolids (Kg/d)		5220	5410	
ADWF (ML/d)		16,80	17,17	

CLOVER POINT PS				
Capacity	Present	2030	2065	Ultimate
Screening		403	403	
Pumping		151,20	148,40	
Primary		0	0	
ADWF (ML/d)		37,80	37,10	



CAPITAL REGIONAL DISTRICT
 CORE AREA WASTEWATER TREATMENT PROGRAM
 WEST SHORE 4X ADFW SECONDARY
 OPTION 1C

DESIGNED	DRAWN	SCALE	CHECKED	APPROVED	DATE	CONTRACT NO.	DWG. NO.	REV.	SHT OF
RAF	PC	NTS	-	-	12/08/09	-	FIG. E.3	-	1 OF 1

**Table E.2
 Major Facilities to be Constructed Under Option 1B**

Location	Description of Facility
Saanich East - North Oak Bay	New secondary plant, new outfall parallel to existing outfall, collection system modifications, influent pumping station, solids discharged to collection system.
Clover Point	Wet weather treatment for 2 - 4 x ADWF, pump station and forcemain to Macaulay Point to transfer flows up to 2 X ADWF for secondary treatment at West Shore. Screening for all flows above 4 X ADWF. The Clover Point treatment plant could be deferred or eliminated pending discussions with regulators.
Macaulay Point	Pump station to convey flows to West Shore for treatment. Pump station would convey up to 2 X ADWF Macaulay and Clover catchments for secondary treatment on West Shore. Wet weather treatment is provided at Macaulay for flows from 2- 4 x ADWF. Screening for all flows above 4 X ADWF.
West Shore	A new secondary treatment plant with integrated biosolids facility to treat flows from the West Shore, Macaulay and Clover Point catchments. Biosolids facilities also treat sludges from Saanich East - North Oak Bay.
Conveyance Facilities	Forcemain to transfer flows from Clover to Macaulay Point for pumping to West Shore. Combined tunnel and forcemain to transfer flows from Macaulay to West Shore.
Outfalls	New Outfalls at Saanich East - North Oak Bay and West Shore.
Resource Recovery	Water reuse facilities built into plant designs at Saanich East - North Oak Bay and West Shore. Heat recovery from effluent built into Saanich East - North Oak Bay, and West Shore Plants. Biosolids resource recovery could include co-digestion, sludge drying, phosphorus recovery and sale of biogas.

**Table E.3
 Major Facilities to be Constructed under Option 1C**

Location	Description of Facility
Saanich East - North Oak Bay	New secondary plant, new outfall parallel to existing outfall plant, collection system modifications, Influent pumping station, solids discharged to collection system.
Clover Point	Pump station and forcemain to Macaulay Point to transfer flows for re -pumping to secondary treatment at West Shore. Screening for all flows above 4 X ADWF.
Macaulay Point	A large pump station to convey flows from Macaulay and Clover Point to West Shore for treatment. Pump station would convey up to 4X ADWF to West Shore for treatment of Macaulay and Clover catchments. Screening for all flows above 4 X ADWF.
West Shore	A new secondary treatment plant with integrated biosolids facility to provide wet weather primary treatment up to 4x ADWF and secondary treatment up to 2 times ADWF from the West Shore, Macaulay and Clover Point Catchments. The plant would have integrated biosolids treatment facilities at the same site as the West Shore plant. Screening for all flows above 4 X ADWF.
Conveyance Facilities	Pump station and forcemain to transfer flows from Clover to Macaulay Point for pumping to West Shore. A large pump station at Macaulay and a combined tunnel and forcemain to transfer flows from Macaulay to West Shore.
Outfalls	New Outfalls at Saanich East - North Oak Bay and West Shore.
Resource Recovery	Water reuse facilities built into plant designs at Saanich East - North Oak Bay and West Shore. Heat recovery from effluent built into Saanich East - North Oak Bay and West Shore Plants. Biosolids resource recovery including co-digestion, sludge drying, recovery and sale of biogas and phosphorus recovery.

E.2 Facility Siting

Potential sites for new facilities are currently being investigated and are summarized in **Table E.4**.

**Table E.4
 Current Siting Opportunities for Treatment Facilities**

Location	Potential Facilities	Comments
Saanich East - North Oak Bay	Secondary Treatment Plant All Options	Three potential sites identified and under discussion.
Clover Point	Wet weather treatment and pumping	Existing site with limited available space, not enough area for secondary treatment plant. Discussing elimination of plant because of infrequency of overflows.
McLoughlin Point	Secondary Treatment Plant	New site which would require purchase and remediation. Risk associated with remediation and schedule impacts. One of the only available sites which could be purchased in the Core Area. Site is constrained with no room for digestion or expansion. Rock excavation and difficult construction conditions anticipated.
Macaulay Point	Wet weather treatment and pumping	Existing site with limited available space. Adjacent land owned by DND. If land could be obtained from DND sufficient space may be available for a new plant.
West Shore – South Colwood	Secondary Treatment Plant and Biosolids Treatment Facility	New site with enough room for future expansions. Land would have to be purchased. Easier construction than Mc Loughlin.
Upper Victoria Harbour	Biosolids Treatment and Processing Facility	There are potentially two sites. One site is small and it will be difficult to site a biosolids processing facility. Other site options may be available.
South Colwood	West Shore plant under Option 1A	Site is small, biosolids treatment facilities would have to be located on adjacent parcel.

Ideally liquid and biosolids treatment facilities should be located at a single consolidated site. Approximate area requirements for a single site would be 8 to 9 hectares.

E.2.1 Design Criteria for New Facilities

The new treatment facilities must be designed to satisfy the Provincial Municipal Sewage Regulation and Federal National Performance Standards. The National Performance Standards which were recently promulgated require secondary treatment plants to meet a performance requirement of cBOD₅ of 25 mg/L and a TSS of 25 mg/L based on a monthly average of at least five samples per week. These standards are similar to the Provincial not to exceed standards of 45 mg/L cBOD₅ and 45 mg/L TSS.

It is not anticipated that facilities will have to be designed for ammonia nitrogen limits for discharge to marine waters.

Compounds of emerging concern (COECs) are a controversial topic in wastewater treatment design. COECs include microconstituents such as endocrine disrupting compounds, pharmaceutically active compounds (PhACs) and personal care products (PCPs). There is still much to be learned about COECs and their impacts on the environment and public health. Research is ongoing. However, it is prudent to plan for wastewater treatment facilities to include the capability for removal of these constituents should it become a requirement in the future.

E.2.2 Liquid Train Treatment Design for Options 1A, 1B and 1C

To enable preparation of cost estimates and assessment of siting options, representative technologies have been selected for evaluation of sites. The final technology selection will be made at the preliminary design phase and may be reconsidered depending on the procurement strategy implemented. This assessment uses proven technologies which have a track record of performance at the scale required for the CRD facilities. The technologies selected will meet the discharge objectives and have been successfully used at many installations in North America and Europe.

When undertaking a major wastewater treatment program such as the CRD project, the owner and engineers often receive submissions by numerous technology suppliers who make many claims with respect to new and novel process performance, footprint, and lower costs. Some of these technologies may show promise, but most lack a track record at the scale of facilities required for CRD. The ability of novel technologies to satisfy discharge requirements at reasonable operating costs is often uncertain. If the CRD wants to consider some of these technologies, a thorough independent evaluation should be completed to confirm suppliers' claims.

For the current evaluations, the following representative technologies have been considered :

- Conventional activated sludge for sites without space limitation such as the West Shore under Options 1A, 1B and 1C.

- Biological aerated filters (BAF) and Membrane Bioreactor (MBR) for sites with limited space availability such as Mc Loughlin Point under Option 1A.
- MBR for locations where a small footprint is desired and a high potential for water reuse exists such as the Saanich East - North Oak Bay plant under all options.
- For wet weather treatment facilities with limited site availability a low footprint technology known as ballasted flocculation (Actiflo) has been selected for assessment purposes.

It is anticipated that larger sites would allow more flexibility in terms of the secondary treatment technology options that could be considered at the implementation stage.

E.2.3 Biosolids Design for Options 1A, 1B and 1C

The biosolids treatment train presents significant opportunities for resource recovery. For this initial assessment it has been assumed the biosolids treatment technology will include thermophillic digestion capable of producing a Class A biosolid, biosolids drying, recovery of biomethane to produce pipeline quality gas, struvite recovery and production of soil amendment product for reuse. In addition, the biosolids facilities are designed to accept organic food wastes and fats, oils and greases (FOG) to enhance the production of biomethane gas by as much as 50%.

A Regional Energy Centre will be a key component of the biosolids management plan for the CRD. This energy centre will integrate biosolids and organic wastes and could have a waste to energy facility as part of the centre to accept solid wastes and biosolids as potential fuel sources, depending on the size of site selected.

Ideally the biosolids and liquid waste treatment facilities should be located at a common site. This is not possible under Option 1A, because the McLoughlin site is too small to accommodate the biosolids treatment facilities. If additional land near McLoughlin can be obtained it would be possible to co-locate on the same site. Federal ownership of adjacent land, and challenges to placing fill in Victoria Harbour reduce the likelihood of expanding the site at McLoughlin Point. Under Option 1B and 1C, the biosolids and liquid train can be accommodated on the sites.

Another option for location of integrated biosolids and solid waste facilities would be the Hartland landfill. This site would involve construction of a pumping station and 17 km pipeline to transfer sludge to a biosolids treatment facility at Hartland landfill. This location would provide good synergies for acceptance of FOG and the organic portion of food wastes to enhance digester gas production. In the future waste to energy facilities could be used as an add-on process for solid waste processing.

E.2.4 Conveyance Systems

Conveyance and pumping upgrades are required for all options. Under Option 1A, wastewater will be conveyed from the Macaulay and Clover Point outfalls by pumping through new forcemains to Mc Loughlin Point. For Option 1B, flows up to 2 times the average dry weather

flow (ADWF) from Macaulay and Clover point are to be pumped to the West Shore for secondary treatment. This will require pumping station upgrades and a tunnel conveyance system crossing the harbour. Option 1C is similar to option 1B but conveyance facilities are larger because up to 4 times ADWF is transferred to the West Shore.

Pumping and conveyance facilities are also required for sludge under Option 1A if a site cannot be located adjacent to Mc Loughlin Point.

New outfalls are required as part of this program. The Saanich East - North Oak Bay plant under all options will require a new outfall parallel to the Finnerty Cove outfall.. For Option 1A, the Macaulay outfall must be upgraded. Under Option 1B and 1C, new outfalls are required for the West Shore plant sites.

E.2.5 Resources from Wastewater

All options present significant potential opportunities for recovery of resources from wastewater. These resources include:

POTENTIAL RESOURCE RECOVERY FROM WASTEWATER

- Effluent Reuse for Irrigation
- Effluent Reuse for Toilet Flushing
- Heat Extraction Plant Use in buildings and digester heating
- Heat Extraction for District Heating
- Biomethane Generation
- Dried Sludge Fuel for cement kilns or waste to energy facility
- Wood Chips – Willow Coppice
- Soil Amendment
- Phosphorus Recovery (Struvite)
- Metals
- Power Generation
- Bio-cell Biomethane

The work completed to date indicates that there is higher potential for recovery of resources than previous work. Opportunities for heat recovery and biomethane from the biosolids train are significant. The market for these resources can be explored further as the project progresses.

E.2.6 Carbon Footprint

A greenhouse gas (GHG) assessment has been completed for all options. In wastewater treatment the relevant GHGs include carbon dioxide, methane and nitrous oxide. The direct and indirect emissions and offsets of the GHGs associated with each alternative have been investigated for the initial construction phase and ongoing operations. Carbon footprint analysis indicates that all options have the potential of being carbon positive depending on the degree of resource recovery implemented. Saleable heat for district heating and biomethane gas sales provide the largest offsets to make the project a carbon positive facility.

E.2.7 Opinion of Probable Costs

The capital and life cycle costs have been developed for each option and are summarized as below:

**Table E.5
 Capital Costs**

Capital Costs	Option 1A	Option 1B	Option 1C
Total Capital Costs	\$965,000,000	\$875,000,000	\$885,000,000

Operations and Maintenance Costs for each option are shown in **Table E.6**.

**Table E.6
 Annual O&M Costs**

	Option 1A	Option 1B	Option 1C
Annual O&M Costs	19.8 million	19.6 million	19.8 million

Life cycle costs for each option are provided in **Table E.7**.

**Table E.7
 Life Cycle Costs**

Costs	Option 1A	Option 1B	Option 1C
Life Cycle Costs	\$806,000,000	\$741,000,000	\$750,000,000

From a capital cost perspective Option 1A is the most expensive option, mainly as a result of difficult construction conditions at McLoughlin Point and the fact that biosolids facilities are located at a separate site remote from the liquid train plant at McLoughlin. Option 1B and 1C have similar capital costs.

Annual operation and maintenance costs are similar for all options.

Option 1A has the highest life cycle cost while options 1B and 1C have similar life cycle costs. Life cycle costs assume that facilities will commence operation in 2016 and are calculated for a 25 year period using a discount rate of 6%.

E.2.8 Triple Bottom Line Analysis of Options

A thorough value based triple bottom line assessment has been used to evaluate options. This TBL approach applied the criteria recommended by the Peer Review Team. Social, environmental and economic criteria groups have been assigned the same maximum point allocation (100 points each) to provide a balanced assessment as per feedback received from the public consultation process. The results of the TBL are summarized in **Table E.7**.

**Table E.7
 Summary Table of TBL Analysis Results**

Criteria Group	No.	Criteria Categories	Measure Description	Weight	Option Results			Comments
					1a	1b	1c	
Economic	EC-01	Capital Costs	construction cost and markup for soft costs adjusted to midpoint of construction	8	2.5	2.7	2.7	Costs included for resource recovery systems
	EC-02	Capital Costs Eligible for Grants	Not available at this time	-	-	-	-	
	EC-03	Tax Revenue Implications	cost of private property lost and lost revenue from reduced property values	1	3	4	4	
	EC-04	Present Worth of O&M costs	O&M costs	8	2.7	2.8	2.7	Costs included for resource recovery systems
	EC-05	Flexibility for Future Treatment Process Optimization	cost of additional tankage needed for process optimization	1	3	4	4	
	EC-06	Expandability for Population Increases	additional space needed versus available to meet 2065 loading	1	3	4	4	
	EC-07	Flexibility to Accommodate Future Regulations	additional space needed versus available to meet potential regulations	1	3	4	4	
Economic Subtotal (100 pts max)¹:					54	60	60	
Environmental	EN-01	Carbon Footprint	tons of eCO2 created	1.67	4	4	4	
	EN-02	Heat Recovery Potential	Heat energy replacing natural gas	1.67	4	2	2	
	EN-03	Water Reuse Potential	megaliters per day available	1.67	4	3	3	
	EN-04	Biomethane Resource Recovery	Recovery of biomethane resources	1.67	3	3	3	
	EN-05	Power (energy) usage	kilowatt hours per year consumed	1.67	3	4	3	Cost also included in EC-04
	EN-06	Transmission Reliability	risk cost of pump station failure	1.67	4	3	1	
	EN-07	Site Remediation	risk cost of site remediation	1.67	2	4	3	
	EN-08	Pollution Discharge	tons of pollutants discharged	1.67	3	3	3	
	EN-09	Non-renewable Resource Use	Gallons of diesel consumed per year	1.67	3	3	3	Cost also included in EC-04
	EN-10	Non-renewable Resource Generated	Struvite and biosolids production	1.67	3	3	3	
	EN-11	Flexibility for Future Resource Recovery	Additional space needed to add 100% additional resource recovery	1.67	2	3	3	
	EN-12	Terrestrial and Inter-tidal Effect	Habitat areas potentially disturbed	1.67	3	3	2	
Environmental Subtotal (100 pts max)¹:					63	63	55	
Social	SO-01	Impact of Property Values	Lost value to present community	1.82	3	3	3	
	SO-02	Operations Traffic in Sensitive Areas	Cost of traffic inconvenience during operations	1.82	1	3	3	
	SO-03	Operations Noise in Sensitive Areas	Cost of noise inconvenience	1.82	3	3	3	
	SO-04	Odour Potential	Cost of odour issues	1.82	2	4	4	
	SO-05	Visual Impacts	Cost of lost open water or territorial view	1.82	3	3	3	
	SO-06	Construction Disruption	Cost of traffic inconvenience due to construction	1.82	1	3	2	
	SO-07	Public and Stakeholder Acceptability	Lost time due to public disapproval	1.82	3	2	2	
	SO-08	Impacts on Future Development	Loss of value of developable land adjacent to plant	1.82	3	2	1	
	SO-09	Loss of Beneficial Site Uses	Loss of park land due to plant	1.82	4	3	2	
	SO-10	Compatibility with Designated Land Use	Delay due to zoning changes	1.82	3	3	3	
	SO-11	Cultural Resource Impacts	Risk cost of a cultural site find	1.82	3	2	2	
Social Subtotal (100 pts max)¹:					53	56	51	
TOTAL SCORE (300 pts max)¹:					170	180	166	

1 - Economic weighting is proportional to NPV results

The results of the analysis indicate that Option 1B has the best TBL score, followed by Option 1A. The difference in scores between Options 1A and 1B is only 10 points and both options are considered viable.

E.2.9 Risk Assessment

A preliminary risk assessment has been completed for each option. Each option was ranked in consideration of the risks associated with construction under each option. Preliminary evaluation indicates that option 1 A has the highest risk mainly due to the unknown impacts of site remediation at the McLoughlin site. Remediation of the site could impact schedule and cost. Option 1B and 1C also have some risk associated with crossing of the harbour with conveyance system tunnels. In terms of siting, Option 1A appears to be the most advanced in terms of the acceptance of plant siting while further negotiations are required for candidate sites on the West Shore.

Risk mitigation strategies can be selected to reduce risks. These strategies will be assessed as the project proceeds and more detailed information becomes available.

E.2.10 Discussion of Analysis and Recommendation

Three options have been reviewed for provision of wastewater treatment to the Core Area. All options are capable of providing wastewater treatment to the Core Area. The CRD is fortunate to have several options available to them. All options have potential for recovery of resources from the liquid and biosolids treatment streams. Options 1B and 1C, located on the West Shore may provide the best flexibility in terms of long term site development, technology selection and ease of construction. There is a real opportunity to extract resources from the wastewater for use in district heating systems and effluent reuse. Dedicated pipelines can be constructed to serve future and existing adjacent residential and commercial areas. Options 1B and 1C also provide sufficient space for integration of biosolids at a single site. Locating liquid stream and biosolids processing at a single site reduces capital and operating costs and optimizes the opportunity for utilizing heat extracted from the effluent for biosolids processing. The drawback to these options are the costs and risks associated with the conveyance facilities crossing the Esquimalt harbour , that are necessary to transport flows to the West Shore for treatment.

Option 1A, with the main secondary plant at McLoughlin Point is also a viable option because of its proximity to the Macaulay and Clover Point outfalls and the fact that the site is available for purchase. The McLoughlin site is contaminated and will require remediation. This presents some risk in terms of overall project schedule as the remediation process could take several years. The site is not large enough to accommodate the liquid and biosolids treatment facilities.

Under Option 1A separate site will be required for biosolids facilities. Biosolids transport between McLoughlin and biosolids processing site will be by pipeline which will be routed past areas for downtown areas. . Hot water heating and effluent reuse pipelines will be constructed in the same trench and will provide immediate opportunity for district heating and reuse of water in government, commercial and residential buildings. Ideally, a biosolids treatment site in closer

proximity to the McLoughlin Point site would be preferred, with an expanded McLoughlin site the best biosolids siting scenario for Option 1A.

Under Option 1A initial investigation indicates that the Macaulay wet weather facilities can be incorporated into the McLoughlin Point plant. The footprint of the Clover Point facility is compact and can be accommodated adjacent to the Clover Point pump station. Because of the infrequency of use it is recommended the CRD continue negotiations with MOE for deferment or elimination of the Clover Point plant. Funds may be better spent on reducing long term infiltration and inflow.

The potential for deferment of West Shore facilities under Option 1A, referred to as 1A prime, has also been investigated. There is an opportunity to defer the West Shore plant under Option 1A for a period of up to 10 years until such time that a new plant is constructed on the West Shore. The CRD together with the West Shore communities would have to commence siting and planning for these facilities within several years of completion of the McLoughlin Point Plant. Potential cost savings for the initial project by deferment of the West Shore facilities would be in the order of \$ 200 million, but there is a risk of losing future senior governments funding for the deferred plant on West Shore.

All three options are good and viable alternatives for providing the CRD with its regional wastewater treatment needs. Comparing alternatives, the only difference between Options 1B and 1C is the location of facilities for handling wet weather flows between 2 and 4 times ADWF. All other site and system components are the same. Despite their similarities, Option 1C rates significantly poorer than 1B on the TBL comparison, principally because of the larger conveyance system for 1C. This results in higher operational costs, less conveyance reliability, and higher construction impacts. For this reason, it appears that of the two similar Options, 1B is more favourable and the project team recommends eliminating 1C from further consideration.

Detailed analysis indicates option 1B has the highest TBL ranking followed closely by 1A with a difference of only 10 points. The CRD has in our opinion two viable options, 1A and 1B which could be considered for implementation.

One of the biggest issues facing the CRD is the availability of plant sites large enough to fit both liquid and biosolids treatment facilities. This fact alone places significant constraints on the project. Ideally a site which is large enough for liquid and biosolids treatment trains (approximately 8-9 hectares) would be preferred, but such a site may not be readily available in the Core Area. Siting investigations are currently being completed to identify candidate sites. It should be noted that the final configuration of the wastewater system will be dictated by the success and results of site identification and acquisition efforts.

Based on the above considerations, the project team recommends the following:

1. Eliminate Option 1C from further consideration.
2. If the CRD has confidence that a site can be obtained on the West Shore, the preferred option is Option 1B and this should be carried forward in the LWMP Amendment. Option 1B is the lowest cost and highest scoring TBL option and would enable integration of all facilities at one site. It can also achieve many of the resource recovery objectives desired by CRD. However, if the CRD feels that public acceptance and site availability will prevent selection of a site on the West Shore under 1B prohibiting timely implementation, then the CRD has the option of selecting Option 1A and carrying it forward in the LWMP.
3. Continue with the Business Case and grant application in consideration of the outcome of recommendation 2 above.
4. Continue to carry forward 1A and 1B until detailed siting investigations and property negotiations are complete. This approach provides advantages to the CRD in the event that one option must be eliminated because of governance or site availability issues. It also provides a fallback position in the event there are issues with site purchase under either option.
5. Proceed with acquisition of a West Shore site. A plant on the West Shore is part of both Options 1A and 1B.
6. Proceed with further technical development, site acquisition, and public consultation with the Saanich East - North Oak Bay facility.
7. Proceed with further technical development and public consultation with the Clover Point pumping station and conveyance pipelines.
8. Proceed to optimize Option 1A by exploring additional land for consolidation of biosolids processing with liquid stream treatment. Alternatives could include additional land adjacent to the McLoughlin site or a new site with sufficient size for consolidated facilities.
9. Continue to further explore the market potential for use of recovered resources and review the return on investment from recovered resources.
10. Continue to further develop and explore opportunities for integrating biosolids and solid waste handling.
11. Continue to discuss the deferment or elimination of the Clover Point wet weather plant with the Provincial Ministry of Environment.

Section 1 Introduction

1.1 Background

The Capital Regional District (CRD) is planning the construction of secondary wastewater treatment plants to serve the Core Area of Greater Victoria. This project, known as the Core Area Wastewater Treatment Program (CAWTP), has been in the planning stages for several years. A number of options from decentralized multi-plant treatment to regional wastewater treatment plant schemes have been investigated. Resource recovery has also been investigated. A significant amount of work was completed on assessing three options, referred to as Options 1, 2 and 3 in previous work. These options varied in terms of the number of plants (4 for Option 1, 7 for Option 2, and 11 for Option 3) and the degree of resource recovery.

A Peer Review Team was engaged by CRD to review Options 1, 2 and 3 identified three sub – options of Option 1 for further consideration by CRD. Options 2 and 3 were eliminated as they were significantly more costly. The Core Area Liquid Waste Management Committee has requested that the three options put forward by the Peer Review Team, referred to as Option 1A, 1B and 1C in this report, be investigated further to refine the economic, social and environmental considerations to enable decision making through a triple bottom line (TBL) analysis.

The Ministry of Environment has requested that secondary treatment be in place by the end of 2016 and the CRD submit their Liquid Waste Management Plan Amendment by the end of 2009. More recently (August 2009) the Federal Minister of the Environment has announced stricter wastewater treatment regulations which will require all communities to have wastewater treatment. To facilitate this schedule, a preferred wastewater treatment strategy must be selected in the near future.

This report presents the evaluation of wastewater treatment options 1A, 1B and 1C.

1.2 Previous Work and Reference Materials

During the preparation of this report various technical and background material were reviewed to obtain insight into the previous work. A significant amount of good work has been completed previously by other consultants, CRD staff and the Peer Review Team. This past work forms a building block for a more detailed assessment of the options to be investigated in this report. Most of the reference documents from previous consulting work can be found on CRD web site.

Reference reports and data from previous studies were used and augmented with more detailed assessments by the current study team.

1.3 Findings of the Peer Review Report

In early 2009 the CRD engaged the services of a Peer Review Team (PRT) consisting of North American wastewater treatment experts to review the work that had been completed by the previous planning consultants. The Peer Review Team outlined twelve guiding principles in their assessment of the wastewater treatment options for the CAWTP. These principles are provided below for reference purposes:

- Meet current and future regulatory requirements.
- Maximize potential opportunities for Integrated Resource Recovery.
- Strive for sustainability.
- Maintain greater flexibility for future options.
- Develop facilities that minimize construction and operating costs.
- Maximize wastewater and sludge management opportunities.
- Avoid sites that are difficult to permit.
- Strive to eliminate intermittently operated wet weather plants.
- Evaluate programs and projects using Triple Bottom Line analysis.
- Maximize benefit to the rate payer.

All of these guiding principles are good considerations and will serve as a basis for continued evaluation of the three options currently under consideration by the CRD. The current consulting team has reviewed the PRT comments and incorporated suggestions where appropriate.

The PRT suggested that Options 1B and 1C, which include regional plants on the West Shore, be investigated further because of the limited site availability, difficult construction and contamination at the McLoughlin site.

The PRT was also concerned with the strategy for disposal of biosolids using willow coppice and cement kilns because the CRD would have to rely entirely on a third party with no back up provision. It was recommended that a back up plan for 100% of the biosolids be available for the CRD. This back up plan should be entirely under the control of CRD so there is no requirement from external parties for disposal of biosolids.

The PRT suggested that a value-based Triple Bottom Line analysis be used to place a value on non – economic factors under environmental and social categories. The TBL presented in this report uses a value based approach for quantification of environmental and social factors to assist the CRD in decision making. As with other TBL assessments completed as part of this project, was used a balanced approach in assessing the economic, environmental and social

categories. The maximum point allocation for each category is the same at 100 points per category.

The current consulting team has reviewed the Peer Review Report and is in general agreement with most of the findings of the report. This report will provide further evaluation and development of some of the concepts suggested by the PRT.

1.4 CRD Goals and Objective for the Core Area Wastewater Treatment Program

The primary goals outlined by the CRD Board for the CAWTP are:

- Protect public health and the environment.
- Manage wastewater in a sustainable manner.
- Provide cost effective wastewater management.

1.5 CALWMC Motions

On June 2, 2009 the Core Area Liquid Waste Management Committee approved further work and evaluation on Option 1 including variations of the strategy referred to as Option 1A, 1B and 1C. This report focuses on item 1 a) of the June 2, 2009 Committee report which says “*Continued analysis of Options 1A, 1B and 1C through the triple bottom line analysis including an assessment of biosolids integration with solid waste activities and functions.*” It also addresses part of 1 h) which says “Research the possibility of a single larger site in the event that the McLoughlin site is not selected.” Other approved work tasks originating from the June 2, 2009 motions are being completed as separate studies.

1.6 Description of Options 1A, 1B and 1C

1.6.1 Option 1A

The facilities to be constructed under Option 1A are illustrated in **Figure 1.1** and summarized in **Table 1.1**. Under Option 1A facilities would be constructed at Saanich East - North Oak Bay, Clover Point, Macaulay / McLoughlin Point and the West Shore. There has been some discussion with MOE regarding the possible deferment of the Clover Point wet weather plant as the frequency of wet weather flows greater than 2 times ADWF is low. Given that CRD is reviewing the opportunities for municipalities to establish inflow and infiltration reduction program, funds may be better spent on improvements to the collection system rather than wet weather treatment. Pumping, conveyance and outfall construction would also be required as part of this option.

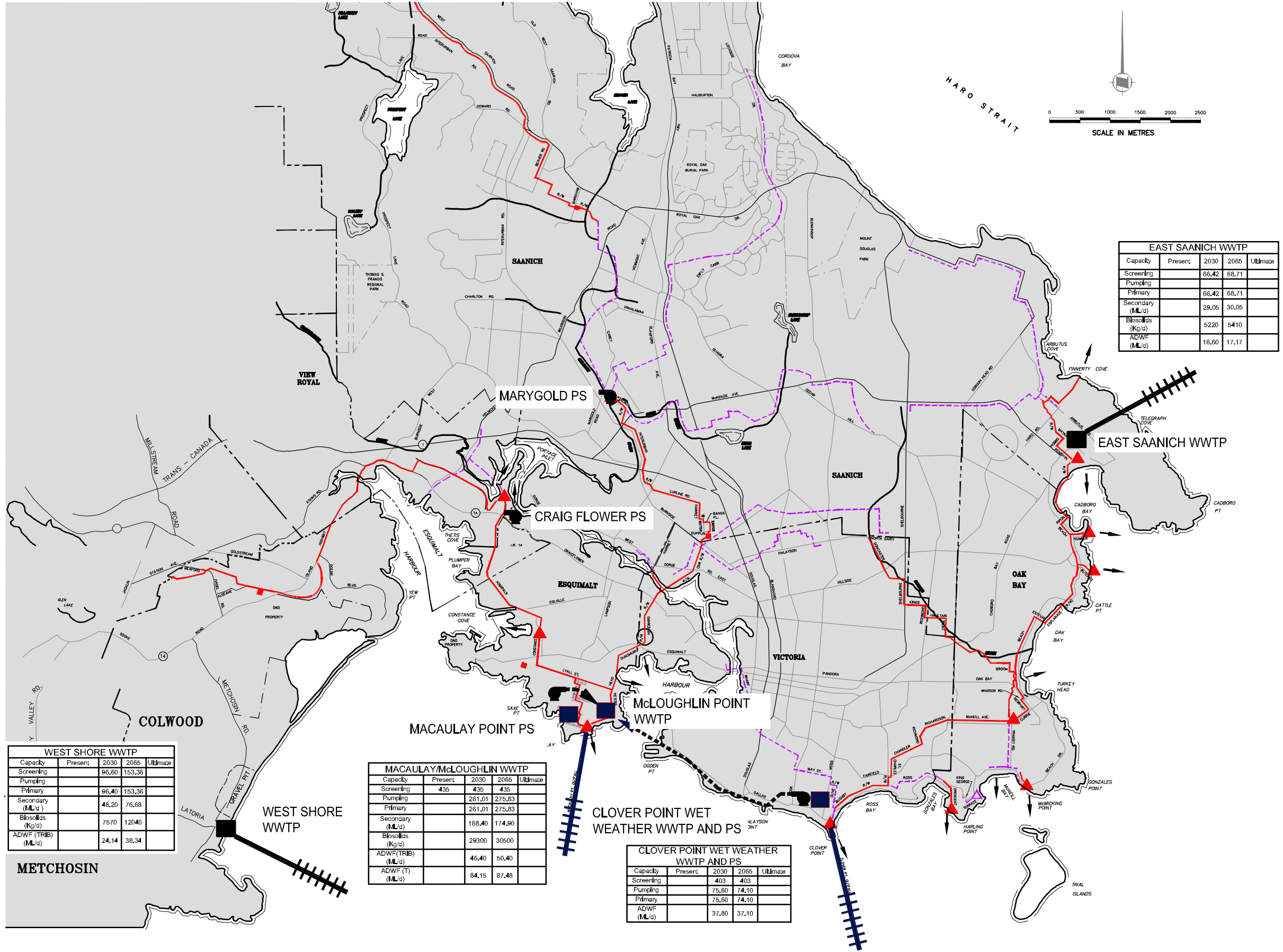

Capacity	Present	2030	2065	Ultimate
Screening		66,42	68,71	
Pumping				
Primary		66,42	68,71	
Secondary		29,05	30,05	
Biosolids (Kg/d)		5220	5410	
ADWF (ML/d)		16,60	17,17	

Capacity	Present	2030	2065	Ultimate
Screening		96,60	153,36	
Pumping				
Primary		96,40	153,36	
Secondary (ML/d)		48,20	76,68	
Biosolids (Kg/d)		7570	12040	
ADWF (TRIB) (ML/d)		24,14	38,34	

Capacity	Present	2030	2065	Ultimate
Screening	435	435	435	
Pumping		261,01	275,83	
Primary		261,01	275,83	
Secondary (ML/d)		168,40	174,90	
Biosolids (Kg/d)		29300	30500	
ADWF(TRIB) (ML/d)		46,40	50,40	
ADWF (T) (ML/d)		84,15	87,48	

Capacity	Present	2030	2065	Ultimate
Screening		403	403	
Pumping		75,60	74,10	
Primary		75,60	74,10	
ADWF (ML/d)		37,80	37,10	

Y:\info\p000010\proj\10-090-TITLE.DWG
 Drawn by: V:\p000002\UPR\MINGUO\10/08/09
 September 18, 2009 5:09 a.m.



SEAL	BY	DATE	No.	REVISION	ENG. No.	DATE	ISSUE



Capital Regional District Environmental Services				CORE AREA WASTEWATER TREATMENT PROGRAM			
DESIGNED	RAF	SURVEYED	-	OPTION 1A KEY PLAN			
DRAWN	PRC	DATE	12/08/09	CONTRACT NUMBER	-	DRAWING NUMBER	FIG. 1.1
SCALE HORIZONTAL	N.T.S.	CHECKED	-	ISSUE	-	SHT. No. OF	-
SCALE VERTICAL	-	APPROVED	RAF				

Table 1.1
Major Facilities to be Constructed Under Option 1 A

Location	Description of Facility
Saanich East - North Oak Bay	New secondary plant, existing outfall upgrade, collection system modifications, influent pumping station, solids discharged to collection system.
Clover Point	Wet weather treatment for 2 - 4 x ADWF, pump station and forcemain to McLoughlin Point to transfer flows up to 2 X ADWF for secondary treatment. Screening for all flows above 4 X ADWF. Wet weather treatment plant could be deferred or eliminated pending discussions with Provincial and Federal regulators.
McLoughlin Point	Secondary treatment plant to treat flows from Macaulay and Clover catchments up to 2 x ADWF. Primary treatment for all flows up to 4 X ADWF. Screening for all flows above 4 X ADWF. Pump station at Macaulay to convey flows to McLoughlin for treatment.
Upper Victoria Harbour	Regional biosolids treatment facility to treat biosolids from the McLoughlin Point plant.
Macaulay Point	Pump Station to convey flows to McLoughlin Point. Macaulay wet weather flows are treated at McLoughlin.
West Shore Plant	New Secondary Treatment Plant and integrated biosolids treatment facility serving only West Shore communities.
Conveyance Facilities	Forcemain to transfer flows from Clover Point to Macaulay. Tunnel or forcemain to transfer flows to McLoughlin.
Outfalls	New Outfalls at Saanich East - North Oak Bay, Macaulay and West Shore
Resource Recovery	Water reuse facilities built into plant designs at Saanich East - North Oak Bay and McLoughlin. Heat recovery from effluent built into Saanich East - North Oak Bay, McLoughlin and West Shore Plants. Biosolids resource recovery including co-digestion, production of soil amendment, recovery and sale of biogas, and phosphorus recovery.

1.6.2 Option 1B

Under Option 1B the main secondary treatment plant is moved to the West Shore from the restricted McLoughlin Point site. Pumping facilities are located at Clover Point and Macaulay to convey up to 2 times average dry weather flow to a regional plant located on the West Shore. Wet weather flows from 2-4 x ADWF are treated using high rate primary treatment facilities (ballasted sedimentation) at Clover Point and Macaulay Point. This concept is shown in **Figure 1.2** and the major facilities are described in **Table 1.2**.

Table 1.2
Major Facilities to be Constructed Under Option 1B

Location	Description of Facility
Saanich East - North Oak Bay	New secondary plant, outfall upgrade, collection system modifications, influent pumping station, solids discharged to collection system.
Clover Point	Wet weather treatment for 2 - 4 x ADWF, pump station and forcemain to Macaulay Point to transfer flows up to 2 X ADWF for secondary treatment at West Shore. Screening for all flows above 4 X ADWF. The Clover Point treatment plant could be deferred or eliminated pending discussions with regulators as frequency of flows greater than 2x ADWF is low.
Macaulay Point	Pump station to convey flows to West Shore for treatment. Pump station would convey up to 2 X ADWF Macaulay and Clover catchments for secondary treatment on West Shore. Wet weather treatment is provided at Macaulay for flows from 2- 4 x ADWF. Screening for all flows above 4 X ADWF.
West Shore	A new secondary treatment plant with integrated biosolids facility to treat flows from the West Shore, Macaulay and Clover Point catchments. Biosolids facilities also treat sludges from Saanich East - North Oak Bay.
Conveyance Facilities	Forcemain to transfer flows from Clover to Macaulay Point for pumping to West Shore. Combined tunnel and forcemain to transfer flows from Macaulay to West Shore.
Outfalls	New Outfalls at Saanich East - North Oak Bay and West Shore
Resource Recovery	Water reuse facilities built into plant designs at Saanich East - North Oak Bay and West Shore. Heat recovery from effluent built into Saanich East - North Oak Bay, and West Shore Plants. Biosolids resource recovery could include co-digestion, sludge drying, phosphorus recovery and sale of biogas.

1.6.3 Option 1C

Option 1C has the main secondary treatment plant located on West Shore providing both wet weather and secondary treatment at a single integrated site. This option is similar to Option 1B but the wet weather facilities are eliminated at Macaulay and Clover Point and all wet weather flow up to 4 times ADWF is transferred to the West Shore for treatment. The disadvantage of this option is that significant pumping and large conveyance facilities are required to transfer the flows to the West Shore. The advantage of this option is that all treatment facilities with the exception of Saanich East - North Oak Bay are located at one site. This concept is shown in **Figure 1.3** and the major facilities are described in **Table 1.3**.

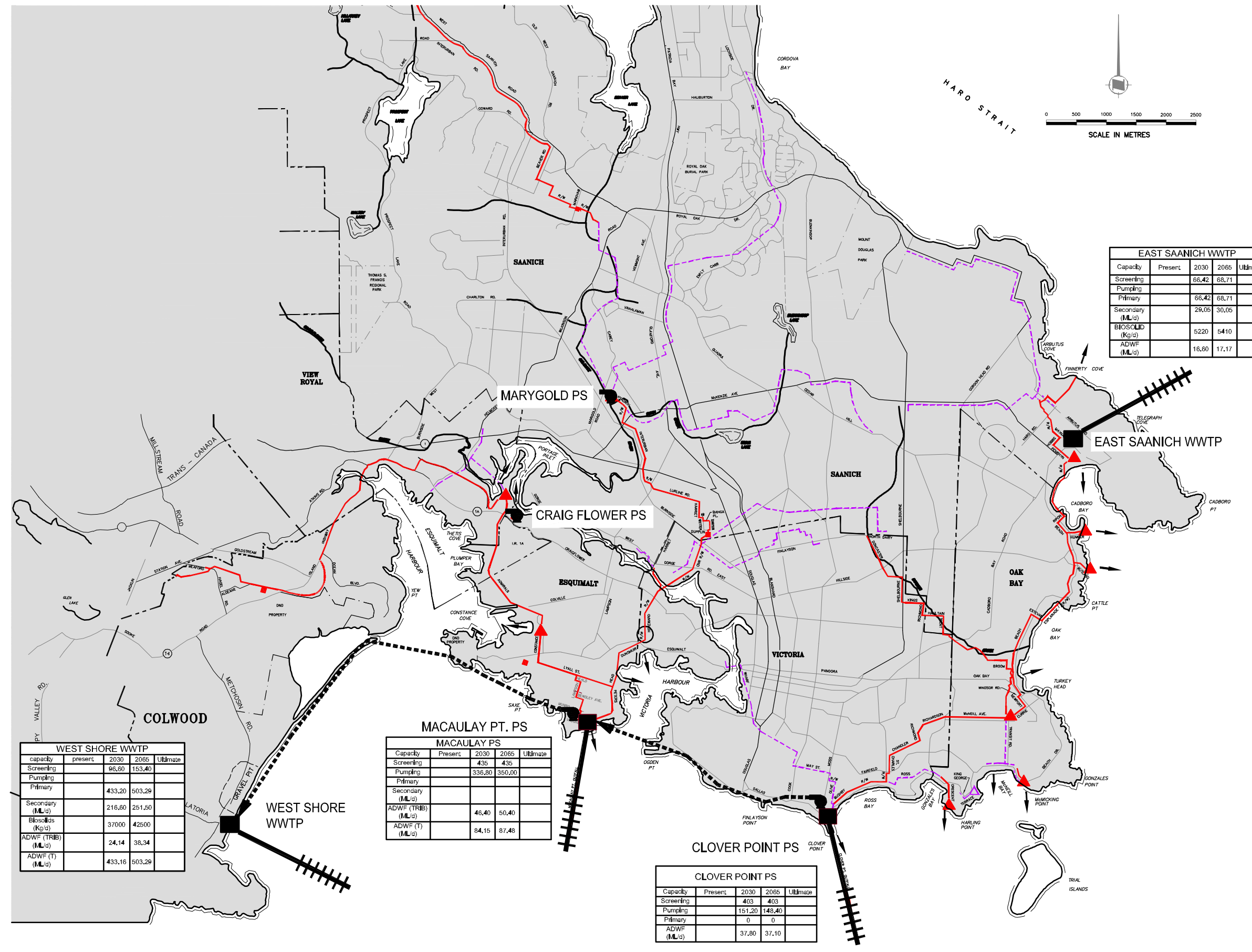

EAST SAANICH WWTP				
Capacity	Present	2030	2065	Ultimate
Screening	66.42	68.71		
Pumping				
Primary	66.42	68.71		
Secondary	29.06	30.06		
BIOSOLID (Kg/d)	5220	5410		
ADWF (ML/d)	16.60	17.17		

WEST SHORE WWTP				
capacity	present	2030	2065	Ultimate
Screening	96.60	153.40		
Pumping				
Primary	433.20	503.29		
Secondary (ML/d)	216.60	251.50		
Biosolids (Kg/d)	37000	42500		
ADWF (TRIB) (ML/d)	24.14	38.34		
ADWF (T) (ML/d)	433.16	503.29		

MACAULAY PS				
Capacity	Present	2030	2065	Ultimate
Screening	435	435		
Pumping	536.80	350.00		
Primary				
Secondary (ML/d)				
ADWF (TRIB) (ML/d)	46.40	50.40		
ADWF (T) (ML/d)	84.15	87.48		

CLOVER POINT PS				
Capacity	Present	2030	2065	Ultimate
Screening	403	403		
Pumping	151.20	148.40		
Primary	0	0		
ADWF (ML/d)	37.80	37.10		

Xref: **sewer** **raw** **owr** **sl** **crp** **tile** **lws**
 Drawn: V:\49014\49014000\DRAWINGS\FIGURES\FIG 1.3.DWG
 September 18, 2009 11:53 a.m.

			<p style="font-weight: bold; margin-top: 5px;">Making a difference...together</p>	Capital Regional District Environmental Services DESIGNED RAF SURVEYED -- DRAWN PRC DATE 12/08/09 SCALE HORIZONTAL N.T.S. CHECKED SCALE VERTICAL -- APPROVED RAF	CORE AREA WASTEWATER TREATMENT PROGRAM OPTION 1C KEY PLAN
	SEAL	BY DATE No.	REVISION	ENG. No. DATE	ISSUE
			CONTRACT NUMBER --	DRAWING NUMBER FIG 1.3	ISSUE --

Table 1.3
Major Facilities to be Constructed under Option 1C

Location	Description of Facility
Saanich East - North Oak Bay	New secondary plant, outfall upgrade, collection system modifications, Influent pumping station, solids discharged to collection system.
Clover Point	Pump station and forcemain to Macaulay Point to transfer flows for re -pumping to secondary treatment at West Shore. Screening for all flows above 4 X ADWF.
Macaulay Point	A large pump station to convey flows from Macaulay and Clover Point to West Shore for treatment. Pump station would convey up to 4X ADWF to West Shore for treatment of Macaulay and Clover catchments. Screening for all flows above 4 X ADWF.
West Shore	A new secondary treatment plant with integrated biosolids facility to provide wet weather primary treatment up to 4x ADWF and secondary treatment up to 2 times ADWF from the West Shore, Macaulay and Clover Point Catchments. The plant would have integrated biosolids treatment facilities at the same site as the West Shore plant. Screening for all flows above 4 X ADWF.
Conveyance Facilities	Pump station and forcemain to transfer flows from Clover to Macaulay Point for pumping to West Shore. A large pump station at Macaulay and a combined tunnel and forcemain to transfer flows from Macaulay to West Shore.
Outfalls	New Outfalls at Saanich East - North Oak Bay and West Shore
Resource Recovery	Water reuse facilities built into plant designs at Saanich East - North Oak Bay and West Shore. Heat recovery from effluent built into Saanich East - North Oak Bay and West Shore Plants. Biosolids resource recovery including co-digestion, sludge drying, recovery and sale of biogas and phosphorus recovery.

1.7 FACILITY SITING

There are a number of factors which must be considered when siting a wastewater treatment facility. These include availability of land, probability of rezoning, cost of land, proximity to the major trunk sewers, room for future expansion, constructability and many other factors. One of the most important factors is the availability of sites for purchase, use of existing sites already under the control of CRD member communities. The CRD has engaged the services of Westland Resource Group to assist in the identification of candidate sites for the treatment plants. Westland has used a triple bottom line approach to assist in identification of candidate sites for sewage treatment. Potential sites have been identified for the Saanich East - North Oak Bay plant and other sites are currently being investigated for plant and biosolids processing

facilities in the Core Area. The sites currently under consideration for the various facilities are summarized in **Table 1.4**. It is noted that these sites have not been finalized and further public consultation and social environmental reviews need to be completed.

**Table 1.4
 Current Siting Opportunities for Treatment Facilities**

Location	Potential Facilities	Comments
Saanich East - North Oak Bay	Secondary Treatment Plant	Three potential sites identified and under consideration.
Clover Point	Wet weather treatment and pumping	Existing site with limited available space, not enough area for secondary treatment plant
McLoughlin Point	Secondary Treatment Plant	New site which would require purchase and remediation. Risk associated with remediation and schedule impacts. One of the only available sites which could be purchased in the Core Area. Site is constrained with no room for digestion or expansion. Rock excavation and difficult construction conditions anticipated.
Macaulay Point	Wet weather treatment and pumping	Existing site with limited available space. Adjacent land owned by DND. If land could be obtained from DND sufficient space may be available for a new plant.
West Shore – South Colwood	Secondary Treatment Plant and Biosolids Treatment Facility	New site with good foundation conditions. Enough room for future expansions. Land would have to be purchased. Easier construction than Mc Loughlin due to gravel foundation conditions
Upper Victoria Harbour	Biosolids Treatment and Processing Facility	There are potentially two site; one site is small and it would be difficult to site a biosolids processing facility. The other site has sufficient size.
South Colwood	West Shore plant under Option 1A	Site is small, biosolids treatment facilities would have to be located on adjacent parcel.

The approximate area for plant construction at each site is provided in **Table 1.5**. These areas are approximate and will be refined as further work is completed.

Table 1.5
Approximate Area for Plant Construction

Site	Area (ha)
Saanich East - North Oak Bay (All Options)	1.5
McLoughlin Point (Option 1A)	1.7
Clover Point (Option 1A, 1B, 1C)	No additional land
Macaulay Point (Option 1A, 1B, 1C)	No additional land
West Shore (Option 1A)	6.1
West Shore (Option 1B)	9.1
West Shore (Option 1C)	9.1
Separate McLoughlin Point Biosolids Site (Option 1A)	2

The final area requirements will vary slightly depending on final facility design and layout.

Section 2 Design Criteria for New Facilities

This section provides background for the selection of design criteria for Options 1A, 1B and 1C.

2.1 Catchment Areas

The catchment areas as previously determined for the Options under consideration include the following:

- **Saanich East - North Oak Bay** – The proposed treatment plant (common to all options) to be located at an as yet undecided location is intended to reduce the flow reaching Clover Point and provide highly treated effluent for a number of reuse opportunities in the University of Victoria area.
- **Clover Point** – Flows from the reduced catchment area (after construction of the Saanich East - North Oak Bay facility) will be redirected to McLoughlin Point, provided with primary treatment and secondary before discharge, or provided with screening and primary treatment before discharge (depending on the magnitude of the flow and the Option being considered).
- **McLoughlin / Macaulay Points** – Flows from the Macaulay tributary area plus transferred flows from Clover Point will be provided with treatment prior to discharge and/or transferred to the West Shore site (Option 1B and 1C), depending on flow and option being considered. A fraction of the flow being treated at McLoughlin/Macaulay will be afforded tertiary treatment for reuse purposes.
- **West Shore** – West Shore tributary flows or tributary flows plus transferred flow from McLoughlin / Macaulay will be afforded various levels of treatment plus discharge or reuse, depending on the option being considered. It is expected that tertiary treatment for reuse will be able to rise quickly as new development areas are brought on-stream in the West Shore communities.

2.2 Current Liquid-Train Regulatory Requirements

Both the Province of BC and the Government of Canada have regulations and/or guidelines that must be considered for receiving water discharge of treated wastewater. Various reuse scenarios also require adherence to stipulated regulations. A wastewater management system is being proposed that consists of ocean discharge of treated effluent plus an increasing amount of effluent reuse. Because of the time constraints imposed by the Province, the equivalent of secondary treatment prior to discharge is required by the end of 2016. Additionally, there are

some aspects of the effluent quality requirements that have recently been promulgated by the Canadian Council of Ministers of the Environment (CCME) that will also have to be satisfied.

2.2.1 Provincial Regulation

In a document entitled “Municipal Sewage Regulations” (MSR) under the Provincial Environmental Management Act, specific requirements for treated effluent quality are listed. If the treated effluent is to be discharged to the “open marine” environment, the regulations stipulate that secondary treatment (defined as effluent containing no more than 45 mg/L each of BOD and TSS at any time) must be provided for all flows up to 2 x ADWF. The limiting concentration values may be interpreted as values that are never to be exceeded, regardless of the type of sample taken.

If flows in excess of 2 times ADWF occur more than once every 5 years, a waste management plan or specific study must be undertaken to determine what treatment level is recommended for such occurrences. If the high flow does (Refer to MSR Section 17(1) and (2)) occur more frequently than once every five years, then the equivalent of primary treatment is acceptable for that high flow period. In the CRD system, flows in excess of 2 x ADWF do occur more frequently than once every five years.

In Schedule 2 of the MSR regulations there are listed both “treatment requirements” and “effluent quality requirements” for treated wastewater that is intended to be used as reclaimed water for a variety of end uses, including irrigation of various crops, landscape irrigation, outside wash water, outside fountains, and toilet flushing. The specific treated effluent constituents listed are pH, BOD, turbidity, and coliform organisms. Any such uses being contemplated by the CRD will have to comply with Schedule 2.

2.2.2 Federal Initiatives

The Canadian Council of Ministers of the Environment (CCME) is comprised of the environment ministers of the federal, provincial and territorial governments. The Council meets at least once per year and focuses on issues that are national in scope and that require collective action by a number of governments. The purpose of the CCME is to assist its members to meet their mandate of protecting Canada’s environment. While the CCME is a collaborative effort, each minister remains accountable to his/her government according to the laws and statutes governing their jurisdiction.

Over the past five years, the CCME has been developing the Canada-Wide Strategy for the Management of Municipal Wastewater Effluent, known as “the CCME Strategy” recently endorsed by the CCME Council of Ministers on February 17, 2009. In August 2009 the Federal Minister of Environment announced stricter effluent regulations which will require communities to have wastewater treatment. Environment Canada has taken the lead in coordinating this effort. Among other things, the CCME Strategy establishes National Performance Standards to be considered, and minimum performance requirements for effluent quality from all municipal,

community and government wastewater facilities that discharge municipal wastewater effluent to surface water. The Federal National Performance Standards for wastewater treatment facilities of a size likely to be installed in the Capital Regional District are:

- $\text{cBOD}_5 \leq 25 \text{ mg/L}$ (monthly average of at least five samples per week);
- $\text{TSS} \leq 25 \text{ mg/L}$ (monthly average of at least five samples per week);
- Total residual chlorine $\leq 0.02 \text{ mg/L}$ (testing is required only if chlorine is used as a disinfectant in the treatment facility; testing to be done three times per day if required).

The monthly average cBOD_5/TSS concentration limits of 25/25 mg/L contained in the CCME National Performance Standards generally are equivalent to the Provincial not-to-exceed concentration limits of 45/45 mg/L for the same parameters.

Wastewater facilities with flow rates in excess of $2,500 \text{ m}^3/\text{d}$, are also required to conduct whole effluent acute toxicity testing and evaluate chronic toxicity at the edge of a specified mixing zone. Given the likely size of the future CRD wastewater treatment facilities, toxicity testing will probably be a monthly requirement. If a facility fails an acute toxicity test, a toxicity reduction and evaluation process is used to identify and correct the cause of the toxicity. If the whole effluent acute toxicity test failure is due to ammonia, then the need for ammonia reduction must be determined on the basis of the assimilative capacity of the receiving environment. Given the BOD_5 and TKN concentrations previously reported for Macaulay Point and Clover Point respectively, and making a simplistic assumption that 0.5 grams of biosolids containing 8% nitrogen will be produced for every gram of BOD_5 removed, the conservatively high estimates for the treated effluent ammonia-nitrogen concentrations from treatment plants located at Macaulay and Clover Points would be in the order of 38 mg/L and 31 mg/L respectively. From an examination of the plot given in **Figure 2.1**, it is unlikely that the future ammonia-nitrogen concentrations in CRD's treated effluent will be an issue for disposal to marine waters, presuming that the pH is less than about 7.8.

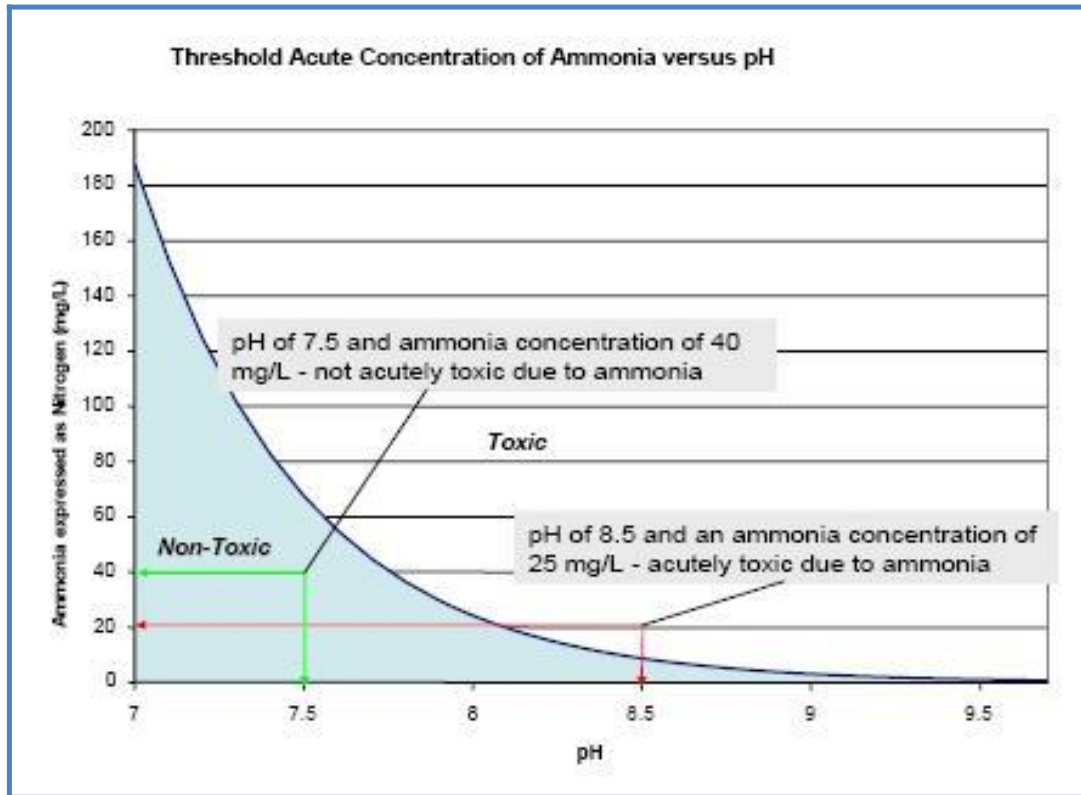

Figure 2.1
Acute Toxicity Relationship Between pH and Ammonia-Nitrogen Concentration
(after Environment Canada, 2007)

2.3 Flexibility for Potential Future Regulatory Changes

There are currently a number of generally present impurities in municipal sewage that are being studied to determine if effluent regulations should be expanded to include some measurable limits. The two main groups of impurities that are candidates for limitations in the CRD setting are probably Greenhouse Gas (GHG) agents and microconstituents such as endocrine disrupting compounds (EDCs), pharmaceutically-active compounds (PhACs), and personal care products (PCPs). Every effort should be made to ensure that any treatment facilities being designed in the near future include a capability for easy addition of treatment reduction for the above impurities of concern should they be necessary in the future. It is unlikely that more stringent nutrient removals will be required for open marine discharge, but many reuse opportunities and any potential surface water discharges will be affected by more stringent effluent nutrient limits.

2.4 Biosolids Regulatory Requirements

Biosolids regulations called “Organic Matter Recycling Regulation” have been issued under the Environmental Management Act and the Health Act. The regulations provide for two classes of biosolids, Class A and Class B, whose characteristics are summarized in **Table 2.1**. Class A biosolids are processed to a higher degree than Class B biosolids, thus having a much lower pathogen concentration in the finished product and have much less restrictive handling and land application requirements. In some respects, the regulation is similar to the U.S. EPA Regulation 503 for biosolids.

The Organic Matter Recycling Regulation also specifies requirements for Classes A and B compost as well as the maximum allowable metal concentrations in biosolids, compost and soils following land application.

Table 2.1
Summary of Biosolids Classification Requirements in
BC’s Organic Matter Recycling Regulation

Characteristic	Class A Biosolids	Class B Biosolids
Pathogen Reduction Requirements	<1,000 MPN per gm (dry solids basis) to be produced by one of the pathogen reduction processes listed below	<2,000,000 MPN per gm (dry solids basis) or one of the pathogen reduction processes listed below
Acceptable Processes for Pathogen Reduction	Thermophilic aerobic digestion at $\geq 55^{\circ}\text{C}$ for at least 30 min	Aerobic digestion with mean cell retention time between 40 days at 20°C and 60 days at 15°C
	Thermophilic anaerobic digestion at $\geq 50^{\circ}\text{C}$ for at least 10 days	Anaerobic digestion with a mean cell retention time between 15 days at 35°C and 60 days at 20°C
	Exposure to time-temperature processing requirements according to arithmetical formulae given in the regulation depending on the total solids concentration of the biosolids	Air drying for >3 months, during which the ambient temperature must be $>0^{\circ}\text{C}$ for at least 2 months
	Alkaline stabilization by maintaining the pH within the biosolids >12 for 72 hours during which $T > 52^{\circ}\text{C}$ for 12 hours, followed by air drying to $>50\%$ total solids concentration	Lime stabilization such that the pH of the biosolids is raised to ≥ 12 after 2 hours of contact
Vector Attraction Reduction Requirements	Aerobic or anaerobic digestion resulting in $>38\%$ destruction of volatile solids mass or another acceptable criterion specified in the Regulation	Aerobic or anaerobic digestion resulting in $>38\%$ destruction of volatile solids mass or another acceptable criterion specified in the Regulation

2.5 Odour Control

Odour emissions from wastewater collection and treatment systems are certainly nothing new. Regardless, neither the BC Municipal Sewage Regulation nor the Organic Matter Recycling Regulation includes specific requirements for odour control. It is reasonable to assume that the public will be intolerant of offensive odours from the new wastewater facilities and thus state of the art odour control equipment needs to be installed to mitigate odours to a reasonable level. It is possible that future regulations could be promulgated employing quantitative odour monitoring such as dilutions to threshold (D/T) at the plant fence line or at the nearest downwind receptor. However such regulations are not on the immediate horizon.

2.6 Wastewater Characteristics

For purposes of process design of liquid train treatment facilities and for estimation of produced biosolids which need to be handled and treated before final utilization or disposal, the comparison of options has been based on a “standard” sewage strength throughout the region following a review of limited wastewater characterization data collected by CRD. Once specific processes have been decided for each treatment site chosen, both the design flows and the design impurity loads will be estimated more closely on a site-by-site basis during the pre-design phase of the project. For this preliminary planning work the approach that has been used is adequate.

For those unit processes at each site that need to be designed on the basis of flow (eg – headworks, primary clarifiers and MBR facilities) the flows mandated by the Provincial regulators have been used, while for the unit processes that need impurity loads for design sizing, BOD₅ and TSS concentrations in the raw wastewater have been taken as 240 mg/L and 195 mg/L respectively at ADWF conditions. Process design sizing has been set at 1.3 times (with exception of Saanich East where 1.75 x ADWF is used for blending) the ADWF conditions so that the process will still provide the mandated effluent quality with flows up to 2 x ADWF, as mandated by the Provincial Regulators.

Such conditions of option comparison are deemed to provide a very realistic relative set of capital and O&M costs for refining option choices.

2.7 2030 and 2065 Design Flow

The design flows used in the following tables are directly derived from the mandated treatment flows sent to CRD by the Provincial Minister of Environment. In summary, these flows and their respective treatment requirements are:

- The equivalent of secondary treatment for up to 2 x ADWF at each discharge point. Secondary treatment is described in the Regulations as meaning never-to-be-exceeded values of 45 mg/L for both BOD₅ and TSS. The Federal requirement is to be 25 mg/L for

both BOD₅ and TSS based on a monthly average. This is similar to the provincial not to exceed standards.

- The equivalent of primary treatment for flows between 2 x ADWF and 4 x ADWF if flows greater than 2 x ADWF occurs more than once in every five years.
- Screening of all flows in excess of 4 x ADWF before discharge to the marine environment.

In the construction of the tables below, these requirements have been adhered to, although in some cases a portion of the flow at any chosen discharge site has been transferred to another discharge site for such treatment when site conditions or costs indicate such a transfer is beneficial.

Since all specific treatment sites have not yet been definitely chosen, some slight revisions to a given plant design flow will probably occur at the time of pre-design activities. However, such slight adjustments will almost assuredly have no implications on the choice of option that is ultimately made.

2.7.1 Option 1A Design Flows

Option 1A was originally proposed by the consultants who carried out the first phase of the project study. This option includes four nodes where some form of treatment is provided, and where an outfall for the ocean disposal of at least a portion of the tributary area. The four chosen locations are Saanich East - North Oak Bay, Clover Point, McLoughlin Point, and West Shore.

The following **Table 2.2** for the **Saanich East - North Oak Bay Plant** provides estimates of design flows which need to be treated to the stipulated level of secondary, primary, or screening only at a site in close proximity to the University of Victoria. Such a site is deemed to have an excellent chance to make substantial use of reuse and recovery opportunities within the university community. For that reason, the treatment process selected is as the previous consultants recommended, which involves the use of membrane bioreactors (MBR) which are capable of producing a plant effluent that is ready-made for many reuse and recovery opportunities. Because of its very high efficiency of treatment, it is not necessary to actually provide a capacity of 2 x ADWF in order to meet the mandated secondary treatment requirement mandated for those periods of time when discharge is through an ocean outfall. By designing the MBR plant to accept 1.75 x ADWF, its effluent can be combined with 0.25 x ADWF that has only received primary treatment, with the recombined blended stream still meeting the mandated secondary treatment level being suggested by the CCME. This approach will result in capital cost savings for the membrane component of the treatment process. Given that there is very little difference between the 2030 and 2065 design flows (0.6 ML/d) all process tankage should be designed for the 2065 flow and installation of membranes staged to easily accommodate increasing flows. It is noted that there are also other

technologies such as conventional and disc filtration which could also provide a high quality effluent for reuse. These options can be explored at the pre-design phase.

All solids removed from the liquid stream at Saanich East - North Oak Bay will be put back into the trunk sewer servicing Clover Point for further forwarding to McLoughlin/Macaulay plant.

Table 2.2
Option 1A - Saanich East - North Oak Bay Design Hydraulic Flows

Item	2030		2065	
	Flow (ML/d)	Action	Flow (ML/d)	Action
ADWF	16.6		17.2	
1.75 x ADWF	29.0 ⁽¹⁾	On-site sec. (MBR)	30.1	On-site sec. (MBR) + reuse or outfall
1.75 ADWF – 4 x ADWF	37.4	On-site prim. only	43.0	On-site prim. Only + outfall discharge
Filtration for Reuse	29.0	≅12 ML/d guaranteed ⁽²⁾	30.1	≅12 ML/d guaranteed
>4 x ADWF	≅ 30	Screening + outfall	≅ 32	Screening + outfall
Biosolids		Discharge to Clover		Discharge to Clover

Notes:

1. By combining the 1.75 ADWF MBR effluent with 0.25 ADWF of PE, the secondary treatment requirement for 2 ADWF can be easily met (25:25).
2. The amount of highly treated reuse water that can be more or less always available is something less than the ADWF.

Table 2.3 below shows the design flow expectations at **Clover Point**, along with the expectations for the various treatment requirements and where those flow ranges will be sent. This Option assumes that 2 x ADWF will be sent to McLoughlin/Macaulay Points for secondary treatment plus some reuse, while the flows between 2 and 4 times ADWF will be provided with primary treatment plus ocean disposal at Clover Point. All solids removed by such primary treatment will be sent on to McLoughlin/Macaulay for further treatment. The same protocol will be used for the flows in excess of 4 x ADWF which will be afforded screening before outfall discharge.

Table 2.3
Option 1A - Clover Point Design Hydraulic Flows

Item	2030		2065	
	Flow (ML/d)	Action	Flow (ML/d)	Action
ADWF	37.8		37.1	
2 x ADWF	75.6	Transfer to McLoughlin	74.2	Transfer to McLoughlin
2 x ADWF – 4 x ADWF	75.6	On-site prim to outfall	74.2	On-site prim to outfall
>4 x ADWF	≅40	On-site screening to	≅40	On-site screening to

		outfall		outfall
Biosolids		Discharge to McLoughlin		Discharge to McLoughlin

In Option 1A, the **McLoughlin / Macaulay Points site** is to be designed to accept the total flows from its own tributary area plus Clover Point design flows that are between 2 and 4 times ADWF. All biosolids from the McLoughlin Point, Clover Point, and Saanich East - North Oak Bay plants will be treated and dried (as appropriate) at an appropriate other site in close proximity since there is not enough room to site biosolids facilities at McLoughlin Point. Potential sites have been identified in the Upper Victoria Harbour. Another scenario would involve pumping the thickened sludge to Hartland Road landfill for final treatment and/or disposal. For the purposes of this study, an Upper Victoria Harbour site has been assumed for costing and evaluation purposes.

Table 2.4 shows the anticipated design flows for the various liquid treatment levels that are required to meet the provincial mandate. The values for tertiary treatment flows are provisional estimates of what flows might have a market for reuse or recovery in the two time frames being considered.

Table 2.4
Option 1A - McLoughlin / Macaulay Point Design Hydraulic Flows

Item	2030		2065	
	Flow (ML/d)	Action	Flow (ML/d)	Action
ADWF(tributary)	46.4		50.4	
2 x ADWF(tributary)	92.8	On-site Secondary	100.8	On-site Secondary
2 x ADWF (from Clover)	75.6	On-site Secondary	74.1	On-site Secondary
Total design flow of 2 x ADWF	168.4	On-site Secondary	174.9	On-site Secondary
2 x ADWF – 4 x ADWF(tributary)	92.8	On-site primary only	100.8	On-site primary only
>4 x ADWF(tributary)	≈50	On-site screening to outfall	≈55	On-site screening to outfall
Filtration for Reuse	12 ¹		24	
Biosolids		To separate site		To separate site

1. The amount of reuse water will vary depending on actual demand.

Within Option 1A, the previous consultants recommended that a separate plant be constructed on the West Shore to provide the necessary treatment levels for the new developments that are expected to occur in that area, plus any conversions of septic tank systems that are near the route of trunk sewers serving the new plant. That recommendation is being used in this assessment. However, there may be justification for changing the boundary between the West Shore plant tributary area and the McLoughlin Point tributary area through some further

wastewater diversion to make better use of the restricted site at McLoughlin Point, or of the staging possibilities at the West Shore plant site.

Table 2.5 shows the flow expectations and the treatment levels required to meet the Provincial mandate at the various flow conditions for the **West Shore** site. All biosolids generated will be treated on site. Again, an allowance has been made for tertiary treatment of a portion of the plant effluent that can be reasonably expected to be in demand for recycle or reuse in the newly developing areas of the West Shore.

Table 2.5
Option 1A - West Shore Design Hydraulic Flows

Item	2030		2065	
	Flow (ML/d)	Action	Flow	Action
ADWF	24.1		38.3	
2 x ADWF	48.2	On-site secondary	76.6	On-site secondary
4 x ADWF – 2 x ADWF	48.2	On-site primary only	76.6	On-site primary only
Filtration for Reuse	6 ¹	On-site post-filtration	18	On-site post-filtration
>4 x ADWF	≅30	On-site screening to outfall	≅40	On-site screening to outfall
Biosolids		On-site treatment		On-site treatment

1. The amount of reuse water can be increased to supply additional demands if necessary.

2.7.2 Option 1B Design Flows

Option 1B was suggested by the Peer Review Team (PRT) as a possible alternative to Option 1A, which potentially would have the apparent benefits of allowing a more conventional (and less expensive) form of secondary treatment, of moving the main treatment facility away from the very small sized site at McLoughlin Point, and of allowing an easier step-wise inclusion of reuse and recycle as the area on the West Shore develops. The CRD subsequently approved this Option as one which should be compared in some detail with the originally proposed Option 1A.

The proposed **Saanich East - North Oak Bay** plant is no different for Option 1B from what was presented for Option 1A, and those flows are repeated below in **Table 2.6**.

Table 2.6
Option 1B - Saanich East - North Oak Bay Design Hydraulic Flows

Item	2030		2065	
	Flow (ML/d)	Action	Flow ((ML/d)	Action
ADWF	16.6		17.2	
1.75 x ADWF	29.0 ⁽¹⁾	On-site sec. (MBR)	30.1	On-site sec. (MBR) + reuse or outfall
1.75 x ADWF – 4 X ADWF	37.4	On-site prim. only	43.0	On-site prim. Only + outfall discharge
Filtration for Reuse	29.0	≅12 ML/d guaranteed ⁽²⁾	30.1	≅12 ML/d guaranteed
>4 x ADWF	≅ 30	Screening + outfall	≅ 32	Screening + outfall
Biosolids		Discharge to Clover		Discharge to Clover

Notes:

1. By combining the 1.75 ADWF MBR effluent with 0.25 ADWF of PE, the secondary treatment requirement for 2 ADWF can be easily met (25:25 BOD₅ / TSS).
2. The amount of highly treated reuse water that can be more or less always available is something less than the ADWF.

As was the case with Saanich East - North Oak Bay design flows, the design flows for **Clover Point** are no different for Option 1B than they were for Option 1A. However, the information is repeated below in **Table 2.7**.

Table 2.7
Option 1B - Clover Point Design Hydraulic Flows

Item	2030		2065	
	Flow (ML/d)	Action	Flow (ML/d)	Action
ADWF	37.8		37.1	
2 x ADWF	75.6	Transfer to Macaulay	74.2	Transfer to Macaulay
2 x ADWF – 4 x ADWF	75.6	On-site prim to outfall	74.2	On-site prim to outfall
>4 x ADWF	≅40	On-site screening to outfall	≅40	On-site screening to outfall
Biosolids		Discharge to Macaulay		Discharge to Macaulay

1. The amount of reuse water can be increased to supply additional demands if necessary.

Under Option 1B, the **Macaulay Point Site** is to be used to treat the flows above 2 x ADWF from the area tributary to that site to either the primary treatment level or screening only (depending on factor above 2 x ADWF). All flows below 2 x ADWF, whether from the direct tributary area or transferred from Clover Point, are to be pumped to a site on the West Shore for secondary and further treatment for reuse streams. All biosolids entering the Macaulay site are also transported to the West Shore site for treatment. **Table 2.8** summarizes those expected flow situations for both 2030 and 2065.

Table 2.8
Option 1B - Macaulay Point Design Hydraulic Flows

Item	2030		2065	
	Flow (ML/d)	Action	Flow (ML/d)	Action
ADWF(tributary)	46.4		50.4	
2 x ADWF(tributary)	92.8	To West Shore	100.8	To West Shore
2 x ADWF(from Clover)	75.6	To West Shore	74.1	To West Shore
Total design flow of 2 x ADWF	168.4	To West Shore	174.9	To West Shore
2 x ADWF – 4 x ADWF(tributary)	92.8	On-site primary only	100.8	On-site primary only
>4 x ADWF(tributary)	≈50	On-site screening to outfall	≈55	On-site screening to outfall

The proposed **West Shore Facility** under Option 1B is intended to be capable of providing secondary treatment for 2 x ADWF from its own tributary area plus the 2 x ADWF generated from both the Macaulay Point and Clover Point tributary areas. The rationale for including this opportunity revolves around the ease of siting a conventional secondary plant at West Shore compared to at McLoughlin Point, the greater potential for inexpensive reuse and recycle of treated sewage as the west Shore area develops, and the ease of siting biosolids facilities at the same location as liquid treatment facilities. **Table 2.9** summarizes the design numbers.

Table 2.9
Option 1B - West Shore Design Hydraulic Flows

Item	2030		2065	
	Flow (ML/d)	Action	Flow (ML/d)	Action
ADWF(tributary)	24.1		38.3	
2 ADWF(tributary)	48.2	On-site secondary	76.6	On-site secondary
2 ADWF(transfer from Macaulay / McLoughlin)	168.4	On-site secondary	174.9	On-site secondary
Total design flow of 2 x ADWF	216.6	On-site secondary	251.5	On-site secondary
4 x ADWF – 4 x ADWF(tributary)	48.2	On-site primary only	76.6	On-site primary only
Filtration for Reuse	6 ¹	On-site post-filtration	18	On-site post-filtration
>4 x ADWF	≈30	On-site screening to outfall	≈40	On-site screening to outfall
Biosolids		On-site treatment		On-site treatment

1. The amount of reuse water can be increased to supply additional demands in the Core Area if necessary.

2.7.3 Option 1C Design Flows

Option 1C was also suggested by the PRT in an effort to centralize both primary and secondary treatment at one site where space is readily available and where the orderly development of recycle and reuse opportunities are considered very possible. The only difference from Option 1B lies in the transport of up to 4 x ADWF across the harbour to the West Shore site and elimination of wet weather treatment facilities at Clover Point and Macaulay Point. The adoption of this Option would mean that all treatment facilities except for the Saanich East – North Oak Bay WWTP and the seldom-used screening and ocean discharge of very high flows would be in one location that is easy to develop.

As was the case for Option 1B, the treatment facility flows at the **Saanich East - North Oak Bay Site** would be the same as for Option 1C, with those conditions being repeated below in **Table 2.10**

Table 2.10
Option 1C - Saanich East - North Oak Bay Design Hydraulic Flows

Item	2030		2065	
	Value (ML/d)	Action	Value	Action
ADWF(tributary)	16.6		17.2	
1.75 x ADWF	29.0 ⁽¹⁾	On-site sec. (MBR)	30.1	On-site sec. (MBR) + reuse or outfall
1.75 ADWF – 4 x ADWF	37.4	On-site prim. only	43.0	On-site prim. Only + outfall discharge
Filtration for Reuse	29.0 ⁽²⁾	≅12 ML/d guaranteed ⁽²⁾	30.1	≅12 ML/d guaranteed
>4 x ADWF	≅ 30	Screening + outfall	≅ 32	Screening + outfall
Biosolids		Discharge to Clover		Discharge to Clover

Notes:

1. By combining the 1.75 ADWF MBR effluent with 0.25 ADWF of PE, the secondary treatment requirement for 2 ADWF can be easily met (25:25).
2. The amount of highly treated reuse water that can be more or less always available is something less than the ADWF.

The facility required at **Clover Point** for Option 1C includes only screening plus discharge through the existing outfall. All other flows and biosolids are forwarded on to Macaulay Point as an intermediate destination on the route to West Shore facilities. These flows are summarized in **Table 2.11** following.

Table 2.11
Option 1C - Clover Point Design Hydraulic Flows

Item	2030		2065	
	Flow (ML/d)	Action	Flow (ML/d)	Action
ADWF(tributary)	37.8		37.1	
2 x ADWF	75.6	Transfer to Macaulay	74.2	Transfer to Macaulay
2 x ADWF – 4 x ADWF	75.6	Transfer to Macaulay	74.2	Transfer to Macaulay
>4 x ADWF	≈40	On-site screening to outfall	≈40	On-site screening to outfall
Biosolids		Discharge to Macaulay		Discharge to Macaulay

As is the case with Clover Point, the **Macaulay Point** site is simply a staging site for pumping of up to 4 x ADWF to the proposed main treatment facility at West Shore. The only works at this site, in addition to the major pump station, will be screening before discharge of flows in excess of 4 x ADWF to the existing outfall at Macaulay Point. All biosolids accumulated at Macaulay will be pumped with the liquid flow to the West Shore site. These actions are summarized below in **Table 2.12**

Table 2.12
Option 1C - Macaulay Point Design Hydraulic Flows

Item	2030		2065	
	Flow (ML/d)	Action	Flow (ML/d)	Action
ADWF(tributary)	46.4		50.4	
2 x ADWF(tributary)	92.8	To West Shore	100.8	To West Shore
2 x ADWF(from Clover)	75.6	To West Shore	74.2	To West Shore
Total design flow of 2 x ADWF	168.4	To West Shore	175.0	To West Shore
2 x ADWF – 4 ADWF(tributary)	92.8	To West Shore	100.8	To West Shore
2 x ADWF – 4 x ADWF(from Clover)	75.6	To West Shore	74.2	To West Shore
>4 x ADWF(tributary)	≈50	On-site screening to outfall	≈55	On-site screening to outfall
Biosolids	From Saanich E, Clover, and Macaulay	To West Shore	From Saanich E, Clover, and Macaulay	To West Shore

All of the flows transferred from Macaulay, as well as the expected tributary flows from the West Shore catchment will be provided with the mandated level of primary and secondary treatment at the **West Shore** facility site. Screening plus ocean discharge will be provided for those tributary flows in excess of 4 x ADWF, and all biosolids produced at or transferred to the West

shore site will be treated as necessary for final disposal or utilization. A summary of design flows at the West Shore site is presented in **Table 2.13**.

Table 2.13
Option 1C - Combined West Shore Design Hydraulic Flows

Item	2030		2065	
	Flow (ML/d)	Action	Flow (ML/d)	Action
ADWF(tributary)	24.1		38.3	
2 x ADWF(tributary)	48.2	On-site secondary	76.6	On-site secondary
2 X ADWF(transfer from Macaulay)	168.4	On-site secondary	174.9	On-site secondary
Total design flow of 2 x ADWF	216.6	On-site secondary	251.5	On-site secondary
2 x ADWF – 4 x ADWF(tributary)	48.2	On-site primary only	76.6	On-site primary only
2 x ADWF – 4 x ADWF(transfer from Macaulay)	168.4	On-site primary only	175	On-site primary only
Filtration for Reuse	6	On-site post-filtration	18	On-site post-filtration
>4 x ADWF	≈30	On-site screening to outfall	≈40	On-site screening to outfall
Biosolids		On-site treatment		On-site treatment

2.7.4 Modified Option 1A – Option 1A^I

A modified Option 1A^I (1A prime) has been considered which defers construction of the 24.1 ML/d West Shore plant for an interim period of 10 years until such time that a new plant is sited and constructed on the West Shore. The McLoughlin Point plant would still be constructed to the maximum 2065 flow of 174.9 ML/d because the difference between 2030 and 2065 flows is only 6.5 ML/d. Current flows generated from the West Shore are 6.8 ML/d. It is noted that this option would be for an interim period only as there is not sufficient space at the McLoughlin Point site to accept flows from the West Shore in the long term. There would be a requirement to upgrade the Craigflower Pump Station and downstream sewers to bring these additional flows to the Macaulay pump station for transfer to McLoughlin Point. Depending on the option selected for upgrading the Craigflower pump station, the capital costs will range between \$10 and \$20 million.

2.8 2030 and 2065 Design Loads

Most unit processes in a conventional secondary treatment plant are designed on the basis of BOD₅ and TSS loads expected to enter that plant in the design year. For purposes of this option comparison, some assumptions have been made that are considered to be appropriate for making a decision on which of the Options (or modified Option) should be taken the next step to

the pre-design phase. The assumptions (based on both available data on CRD wastewater characteristics and accepted design practice) that were used are listed below.

- A raw sewage ADWF BOD₅ of 240 mg/L has been used for all tributary areas.
- A raw sewage ADWF TSS of 195 mg/L has been used for all tributary areas.
- A primary clarification efficiency of 55% has been used for TSS removal.
- A primary clarification efficiency of 30% has been used for BOD₅ removal.
- A net yield factor of 0.8 has been used for conversion of primary effluent (PE) BOD₅ to secondary solids.
- A factor of 1.3 has been applied to ADWF load to account for increases in loads that occur at flows above ADWF conditions.

For purposes of Option comparisons, it has been assumed that flows greater than 2 x ADWF occur so infrequently and at reduced BOD and TSS concentration, that the use of the 1.3 multiplying factor will more or less account for the biosolids load at flows up to that value of 2 x ADWF. These factors can range from 1.1 – 1.4 ADWF depending on the characteristics of the catchment area, commercial and industrial contributions and I & I. For preliminary analysis 1.3 is deemed appropriate. This factor is used to account for maximum month load conditions for process design. For the peak 14 day period for digester design a value of 1.4 x ADWF was used.

2.8.1 Option 1A Design Loads

Using the values described above, the design loads for the Saanich East - North Oak Bay facility were estimated, and the results entered into **Table 2.14** below. Additionally, the calculated design mass of biosolids produced per day at the design loads are entered.

Table 2.14
Option 1A - Saanich East - North Oak Bay Secondary Treatment Design Loads

Item	Flow (ML/d)	Conc. (mg/L)	Load (kg/day)	Action
ADWF BOD₅	17.2	240	4,130	
ADW TSS	17.2	195	3,350	
Process Des. BOD₅ (1.3 x ADW)			5,370	On-site treatment with MBR
Process Des. TSS (1.3 x ADW)			4,360	
Primary Biosolids (55% removal)			2,400	To Clover Point
Second. Biosolids (30% removal in PC) (0.8 yield factor)			3,010	To Clover Point

Note: 2065 ADWF used because it is estimated to be only marginally higher than 2030 value.

Since no secondary treatment is considered at Clover point, there will be no primary or secondary biosolids to separately account for at that site. The BOD₅ and TSS loads in the sewage up to 2 x ADWF will simply be transported on to McLoughlin/Macaulay for inclusion in the treatment loads at that site. The biosolids from Saanich East - North Oak Bay will simply be passed on down the line to McLoughlin/Macaulay. These numbers are summarized in **Table 2.15**.

Table 2.15
Option 1A - Clover Point Primary Treatment Design Loads

Item	Flow (ML/d)	Conc. (mg/L)	Load (kg/day)	Action
ADWF BOD ₅	37.8	240	9,070	
ADWF TSS	37.8	195	7,370	
Process Des. BOD ₅ (1.3 x ADW)			11,790	To McLoughlin
Process Des. TSS (1.3 x ADW)			9,580	To McLoughlin
Primary Biosolids (55% rem.)			5,270	
Second. Biosolids (30% rem in PC) (0.8 yield factor)			0	
Biosolids from Saanich East - North Oak Bay			5,410	To McLoughlin

The proposed secondary treatment facilities at McLoughlin/Macaulay for Option 1A will be capable of providing secondary treatment to flows up to 2 x ADWF from both the Macaulay Point catchment and the Clover Point catchment. In addition the site will provide primary treatment only for tributary flows between 2 and 4 times ADWF, and biosolids treatment is envisaged either at McLoughlin Point or some yet to be selected nearby site. These design loads are summarized in **Table 2.16**.

Table 2.16
Option 1A - McLoughlin/Macaulay Secondary Treatment Design Loads

Item	Flow (ML/d)	Conc. (mg/L)	Load (kg/day)	Action
ADWF BOD ₅	46.4 + 37.8 from Clover	240	20,210	
ADWF TSS	46.4 + 37.8 from Clover	195	16,420	
Process Des. BOD ₅ (1.3 x ADWF)			26,270	On-site secondary
Process Des. TSS (1.3 x ADWF)			21,350	On-site secondary
Extra TSS from Saanich East - North Oak Bay			5,410	On-site secondary
Primary Biosolids (55% rem.)			14,720	
Second. Biosolids (30% rem in PC) (0.8 yield factor)			14,710	
Total biosolids			29,430	Off-site treatment

In Option 1A the proposed works at a West Shore site will be designed to treat tributary flows from newly developed areas of the West Shore communities and from some properties currently serviced by septic tanks. Secondary treatment is provided for flows up to 2 x ADWF, and primary treatment is provided for flows between 2 and 4 times ADWF. Flows in excess of 4 x ADWF are to be screened before ocean discharge. An allowance has been made for tertiary treatment of a portion of the secondary effluent for reuse and recovery purposes, with such flows being identified in Table 2.5, since hydraulic design (rather than impurity load) governs such treatment. This information is summarized in the following **Table 2.17**.

Table 2.17
Option 1A - West Shore Secondary Treatment Design Loads

Item	Flow (ML/d)	Conc. (mg/L)	Load (kg/day)	Action
ADWF BOD ₅	24.1	240	5,780	
ADWF TSS	24.1	195	4,700	
Process Des. BOD ₅ (1.3 x ADWF)			7,510	On-site secondary treatment
Process Des. TSS (1.3 x ADWF)			6,110	On-site secondary treatment
Primary Biosolids (55% rem.)			3,360	
Second. Biosolids (30% rem in PC) (0.8 yield factor)			4,210	
Total Biosolids			7,570	On-site treatment

2.8.2 Option 1B Design Loads

Option 1B was suggested by the PRT as a possible alternative to Option 1A, which had the apparent benefits of allowing a more conventional (and less expensive) form of secondary treatment, of moving the main treatment facility away from the very minimally sized site at McLoughlin Point, and of allowing an easier step-wise inclusion of reuse and recycle as the area on the West Shore develops. The CRD subsequently approved this Option as one which should be compared in some detail with the originally proposed Option 1A.

As was the case for the hydraulic design conditions, the design load conditions for the Saanich East - North Oak Bay facility are no different for Option 1B than for Option 1A, but the load estimates are repeated below in **Table 2.18**.

Table 2.18
Option 1B - Saanich East - North Oak Bay Secondary Treatment Design Loads

Item	Flow (ML/d)	Conc. (mg/L)	Load (kg/day)	Action
ADWF BOD₅	17.2	240	4,130	
ADWF TSS	17.2	195	3,350	
Process Des. BOD₅ (1.3 x ADWF)			5,370	On-site treatment with MBR
Process Des. TSS (1.3 x ADWF)			4,360	
Primary Biosolids (55% rem.)			2,400	To Clover Point
Second. Biosolids (30% rem in PC) (0.8 yield factor)			3,010	To Clover Point

Note: 2065 ADWF used because it is estimated to be only marginally higher than 2030 value.

As was the situation with Saanich East - North Oak Bay, the loading design for Clover Point facilities is no different for Option 1B than for Option 1A. The information is repeated below in **Table 2.19**.

Table 2.19
Option 1B - Clover Point Primary Treatment Design Loads

Item	Flow (ML/d)	Conc. (mg/L)	Load (kg/day)	Action
ADWF BOD₅	37.8	240	9070	
ADWF TSS	37.8	195	7370	
Process Des. BOD₅ (1.3 x ADWF)			11790	To Macaulay
Process Des. TSS (1.3 x ADWF)			9580	To Macaulay
Primary Biosolids (55% rem.)			5270	
Second. Biosolids (30% rem in PC) (0.8 yield factor)			0	
Solids from Saanich East - North Oak Bay			5410	To Macaulay

In Option 1B the utilization of the McLoughlin/Macaulay site is limited to primary treatment for flows between 2 and 4 times ADWF, screening for flows above 4 x ADWF, ocean outfall pumping, and pumping for 2 x ADWF plus received biosolids to the West Shore facility described later. These loads and a description of how they are handled at McLoughlin/Macaulay are summarized in **Table 2.20**.

Table 2.20
Option 1B - Macaulay Point Primary Treatment Design Loads

Item	Flow (ML/d)	Conc. (mg/L)	Load (kg/day)	Action
ADWF BOD₅	46.4 + 37.8 from Clover	240	20210	
ADWF TSS	46.4 + 37.8 from Clover	195	16420	
Process Des. BOD₅ (1.3 x ADWF)			26270	To West Shore
Process Des. TSS (1.3 x ADWF)			21350	To West Shore
Extra TSS from Saanich East - North Oak Bay			5410	To West Shore
Total TSS			26760	To West Shore

Under Option 1B the West Shore site becomes the only one other than Saanich East - North Oak Bay that requires secondary treatment facilities. All flows up to 2 x ADWF from both Clover Point and McLoughlin/Macaulay catchments are forwarded to the West Shore site. Biosolids from the entire region will be treated at a West Shore facility, and primary treatment and/or screening will be provided for West Shore tributary flows in excess of 2 x ADWF. An allowance

for tertiary treatment for reuse purposes has been made, and the assumed flows undergoing such additional treatment are shown in Table 2.9. A summary of these design allowances is shown in **Table 2.21**.

Table 2.21
Option 1B - West Shore Secondary Treatment Design Loads

Item	Flow (ML/d)	Conc. (mg/L)	Load (kg/day)	Action
ADWF BOD₅	24.1	240	5780	
ADWF TSS	24.1	195	4700	
Process Des. BOD₅ (tributary) (1.3 x ADWF)			7510	
Process Des. BOD₅ (transfer)			26270	
Tot. Process Des. BOD₅			33780	On-site secondary treatment
Process Des. TSS (tributary) (1.3 x ADWF)			6110	
Process Des. TSS (transfer)			26760	
Tot. Process Des. TSS			32870	On-site secondary treatment
Primary Biosolids (55% rem.)			18080	
Second. Biosolids (30% rem in PC) (0.8 yield factor)			18920	
Total Biosolids			37000	On-site treatment

2.8.3 Option 1C Design Loads

The design facility loads that affect secondary treatment processes do not increase significantly over those presented in **Tables 2.18 to 2.21**, because the only source of extra BOD₅ and TSS loads that reach the West Shore site are from the fairly extreme wet weather flows that are not expected to significantly add load because of the reduced concentrations of BOD₅ and TSS that are expected during such high flows. Therefore, for purposes of comparing alternatives, it is recommended that the same secondary treatment design loadings be used for Option 1C as have already been proposed for Option 1B.

Any treatment process design that relies on design flow rather than design load may be different in Option 1C than Option 1B. Such differences are noted in **Tables 2.10 to 2.13**.

Section 3 **Liquid Train Design for Option 1A, 1B and 1C**

3.1 **General**

Previous conceptual design work to date by CRD consultants analyzed three options consisting of Option 1 with 4 plants; Option 2 with 7 plants; and Option 3 with 11 plants. The increasing number of plants for these options was investigated to determine whether decentralized dispersed treatment would enable more efficient extraction of resources from the liquid and solids streams. The previous study results were as follows:

- Option 1 (4 plants) - Capital cost \$1.2 billion, operating cost \$23 million/year, revenue from resources \$3.5 million/year
- Option 2 (7 plants) - Capital cost \$1.6 billion, operating cost \$ 28 million/year, revenue from resources \$ 7 million/year
- Option 3 (11 plants) - Capital cost \$ 2.0 billion operating cost \$33 million/year, revenue from resources \$8 million/year

The PRT included six distinguished wastewater treatment experts retained by the CRD to review and comment on the concepts developed by the previous consultants. They recommended that further analysis should concentrate on optimizing Option 1. For the initial design period up to 2030 the business case for providing more distributed wastewater treatment for CRD was not viable. We concur with this finding and are of the opinion that siting decentralized plants would be difficult and capital costs would be significantly increased. The PRT indicated that two modified options, 1B and 1C should be compared to the original, 4 plant Option 1 which they referred to as Option 1A. In addition the PRT indicated that the choice of membrane bioreactor technology (MBR) was not justified by the effluent discharge requirements and was very expensive from a capital and operational cost viewpoint. It was recommended that more conventional alternative secondary treatment options such as conventional activated sludge (CAS) should be considered if sufficient land was available. They also suggested that the plants could be developed in modules which would result in hybrid plant systems with the major portion of the capacity developed initially as CAS for example and a lower capacity module based on membrane technology or fabric tertiary filters to satisfy the higher quality effluent requirements for effluent reuse for irrigation and toilet flushing.

3.2 Representative Secondary Treatment Technologies

To enable comparison of costs and assessment of siting, representative technologies have been selected for this evaluation. The representative technologies all use proven secondary wastewater treatment processes which will meet the discharge objectives and which have been constructed at numerous other locations in North America and Europe. It is possible that these technologies could change depending on the procurement process and final siting of facilities.

When undertaking a major wastewater treatment program such as the CRD, the CRD will be inundated with many new and novel technology suppliers who make many claims with respect to process performance and cost. While many of these technologies show promise, many have no track record or history at the scale of facilities required for CRD. Any future assessments of these novel technologies should consider the long term operating costs, reliability and track record at a similar scale.

Considering the discussion on effluent requirements in Section 2 of this report, a biological treatment plant capable of producing an effluent quality (never to be exceeded) of 45 mg/L BOD₅ and TSS will need to be provided for each of the plants serving the CRD for flows and organic loads up to 2 times ADWF. This is the Provincial Ministry of Environment standard for effluent discharge via outfalls to the open marine environment. Such an effluent quality can reliably be met or exceeded by a range of treatment technologies including: conventional activated sludge systems (CAS), or fixed film systems such as trickling filter/solids contact (TF/SC) and biological aerated filter (BAF) processes, or hybrid systems which incorporate characteristics of both suspended growth and fixed film processes such as Integrated Fixed Film Activated Sludge (IFAS) processes or moving bed bioreactors (MBBR). Membrane bioreactor (MBR) activated sludge systems as previously proposed were also considered appropriate because of their small footprint and for sites where a high proportion of the effluent has a high reuse potential.

For municipal applications proven processes which have a track record at other locations throughout North America were only considered. While there are a number of new and emerging technologies being promoted by many suppliers, their track record, performance and operating cost is unproven at the scale required for the CRD installation. A preliminary assessment of secondary process options based upon relative capital and operating cost and track record in Canada and USA as well as such considerations as aesthetics of the facilities resulted in the following choices of technology for CRD in this options evaluation.

- Conventional Activated Sludge (CAS) for sites with no space limitation (West Shore).
- Biological Aerated Filters (BAF) for limited site applications (McLoughlin Point).
- Membrane Bioreactor (MBR) activated sludge systems for locations where visual aesthetics is especially important, where high effluent reuse potential exists, as well as where site space limitations are a reality (Saanich East - North Oak Bay).

A goal of the CRD Core Area Wastewater Treatment Program project is to optimize the amount of resource recovery from each of the wastewater treatment and biosolids processing facilities developed to serve the sewered area. This includes reuse of the effluent for irrigation and utilization for toilet flushing purposes. For both of these reuse purposes the degree of treatment must be high. To maximize the potential for effluent reuse the initial concepts for sewage treatment were based on the use of membrane bioreactors (MBR's) which are essentially a small footprint activated sludge systems which use permeable membranes for separation of biosolids from the effluent. Such systems produce a very high quality effluent (e.g. < 2 mg/L BOD and < 1 mg/L TSS) combined with removal of most microorganisms including bacteria which can be pathogenic. Because of the concentrated biological organism population in the bioreactors preceding the membranes, the long contact time (sludge age), results in conversion of the ammonia in the wastewater to nitrates and subsequently to nitrogen gas through biological nitrification and denitrification provided sufficient alkalinity is available in the wastewater.

The CAS system is the most widely used process for secondary treatment worldwide, is quite flexible for incorporation of future technology, and can be constructed for a reasonable capital cost and operated at an acceptable operating cost. This is the technology selected for the West Shore under Options 1A, 1B and 1C. It also has the advantage of being able to increase the future capacity without additional process tankage by placing membranes in the secondary clarifiers or some aeration tanks.

Raw wastewater with a BOD of 240 mg/L and TSS concentration of 195 mg/L would first be pretreated by fine screening 6mm openings and grit removal prior to primary settling. These preliminary processes are required to remove floatable solids which are unsightly and would cause odour problems during subsequent processing, and inorganic solids which cause excessive wear on mechanical equipment. In the primary settling tanks organic solids settle out, reducing the TSS load and BOD load to the bioreactors by about 55% and 30%, respectively. Primary sludge is typically thickened to a concentration of about 4% solids and is fed to the anaerobic digestion sludge stabilization facilities. Either circular or rectangular primary sedimentation tanks can be utilized at any of the plants proposed for CRD. Storm flows up to 4 times ADWF will be passed through the primary settling process. To minimize the plant footprint of the primary settling at all of the plants lamella plate high rate settling facilities will be utilized and chemical feed systems added, which at high flow rates between 2 and 4 times ADWF would allow operation as high rate chemically enhanced primaries (CEP). Alum at a dosage of about 70 mg/L and polymer at a dosage of about 1 mg/L would be applied during these high flow times. The lamella primary tanks would be sized at a surface overflow rate of 13 m³/m²/hr.

The clarified primary effluent with a BOD of about 170 mg/L and a TSS of about 90 mg/L is introduced into the suspended growth bioreactor tanks where activated sludge (a mixture of microorganisms) grows and adsorbs and biologically degrades the organics in an aerobic environment to produce carbon dioxide, water, and new activated sludge (AS) cells. The activated sludge concentration in the bioreactors is typically operated between 1500 and 3500 mg/L and is kept in suspension by the addition of compressed air added from a blower system

and fine bubble diffusers installed at the bottom of the 4 to 5 m deep bioreactors. After a hydraulic retention time of about 6 hours, the contents of the bioreactors, called mixed liquor, is introduced to final settling tanks (secondary clarifiers) where the biological solids are separated from the liquid effluent by gravity. About 70 to 100 % of the activated sludge is pumped back as return activated sludge (RAS) to the head end of the bioreactor to seed and maintain the biological treatment. The remainder of the settled sludge with a solids concentration of about 0.6 to 1.0 % solids is wasted as waste activated sludge (WAS), thickened, and then fed to the anaerobic digesters. During this biological process the liquid effluent concentration is reduced typically to below 10 mg/L BOD and TSS. Layouts for the various treatment processes for Options 1A, 1B and 1C are included in drawings under Volume II.

3.3 Option 1A Liquid Train Treatment

Treatment facilities for Option 1A will be located at the same sites as identified for Option 1 proposed by the previous consultants. There will however be a difference in the type of treatment plant process proposed for two of the facilities. The previous work universally used membrane bioreactor (MBR) activated sludge systems for all of the secondary facilities. For Option 1A evaluated in this report, the types and 2030 capacities for the secondary treatment facilities are listed and then discussed below:

- Saanich East - North Oak Bay: A 16.6 ML/day membrane activated sludge plant (MBR) with membrane capacity to handle up to 29 ML/d during wet weather conditions.
- Clover Point: A 75.6 ML/d ballasted sedimentation (i.e. Actiflo) wet weather high rate primary plant at. Pending negotiations with MOE it may be possible to defer this plant as the plant operates for only a total of one week per year.
- McLoughlin Point: 168.4 ML/day biological aerated filter (BAF) as primary option with MBR as a secondary option for comparison purpose. Wet weather facilities for Macaulay catchment are incorporated into the McLoughlin site so there are no wet weather facilities at Macaulay Point.
- West Shore: 24 ML/day conventional activated sludge plant (CAS).

3.3.1 Saanich East - North Oak Bay MBR

The Saanich East - North Oak Bay plant is intended to be located in close proximity to the University of Victoria. Because of the high probability of a major portion of the plant flow utilization for effluent reuse for irrigation, cooling, toilet flushing at the university, the decision was made to provide a high level of treatment i.e. membrane bioreactor technology (MBR) for irrigation, water reuse and heat recovery. The Finnerty Cove outfall also will terminate in marine waters that do not have as high a degree of tidal flushing as the Macaulay and Clover locations on Strait of Juan de Fuca. The membrane treatment capacity will be designed for 1.75 times ADWF (29 ML/day) and the high quality effluent will be combined with up to 0.25 times ADWF

(4.2 MI/day) of primary effluent (to achieve an equivalent effluent load of TSS and BOD as a secondary treatment facility designed for a capacity of 2 times ADWF (33.4 ML/day).

All flows tributary to the plant will be screened using 2 mm opening screens.

Flows up to 4 times ADWF 66.4 ML/day will be treated in lamella plate equipped high rate primary settling tanks which will have a surface overflow rate (SOR) of 13 m/hr. Facilities will be available for addition of 70 mg/L of alum and 1.5 mg/L of polymer so that wet weather flows will receive chemically enhanced primary treatment (CEPT). It is expected that the CEP treatment of storm flows will achieve BOD and TSS levels in the primary effluent of about 80 and 60 mg/L respectively.

Primary effluent flows up to 1.75 times ADWF will pass through fine screens (2mm openings) and then flow to a suspended growth bioreactor in which the AS concentration will be maintained at a high level of about 8000 mg/L and the retention time at ADWF will be about 4 hours. This MBR bioreactor will be subdivided into anoxic (no aeration, mechanical mixing only) and aerobic sections which will be aerated to maintain a high dissolved oxygen level of about 2.5 mg/L. The bioreactor tank will be followed by a membrane tank which will contain hollow fibre micro filtration acetate membranes which will achieve separation of the AS from the liquid effluent by applying a vacuum across the semi permeable membranes. A portion of the separated sludge will be returned to the bioreactor as RAS to seed the biological processes. The remainder of the sludge (approx 5410 kg/day) referred to as waste activated sludge (WAS) will be wasted to the sewer system downstream of the plant towards Clover Point.

The pore size on the membranes will be < 2 microns which will provide a physical barrier to organic and inorganic solids and even to microorganisms including bacteria. The MBR plant quality will be very high, 2 mg/L BOD and < 1 mg/L TSS with very low bacteria populations of 1 or 2 TC/100 ML. During storm flows up to 2 times ADWF, the combined MBR and CEP effluent will easily meet the effluent requirements for discharge to the marine environment. Because of the high AS concentration and long sludge age of > 20 days as well as the process configuration nitrification (ammonia conversion to nitrates) and denitrification will occur insuring no effluent toxicity to fish. The MBR plant effluent will be suitable for reuse for irrigation and use for toilet flushing on the nearby university properties, golf courses and parks. That portion of the effluent used for these purposes will be disinfected using UV irradiation and probably chlorination to retain an appropriate residual chlorine level.

3.3.2 Clover Point Wet Weather Treatment

The requirement for a wet weather treatment plant at Clover Point is under review with MoE. Significant costs of \$68.5 million would be better spent on collection system improvements to reduce infiltration and inflow.

If required, a compact design has been developed for the wet weather high rate primary treatment at Clover Point. This facility will use Actiflo ballasted flocculation and will only operate

during wet weather conditions when flows exceed 2 x ADWF. Ballasted flocculation use a proprietary high rate technology using polymer and a sand ballast to agglomerate the floc particles which results in faster settling, a higher design surface loading rate and a smaller facility footprint. Such facilities are in place at a number of facilities in North America including areas with similar climatic conditions such as Washington State. For preliminary sizing purposes, surface overflow rate is selected at 100 m/hr for preliminary planning purposes.

Grit removal facilities will be located upstream of the Actiflo process. Chemical storage facilities will be located in or adjacent to the existing Clover Point pumping station.

3.3.3 Biological Aerated Filter

A biological aerated filter design provides the most compact design on the Mc Loughlin Point site. BAF is an attached growth process where a polystyrene or shale filter bed in the order of 3 to 4 metres is used as a filter media. The reactor also uses compressed air which is introduced into the filter bed to satisfy oxygen demand of aerobic microorganisms. The yield of excess sludge is similar to activated sludge at between 0.8 to 0.9 kg cells/ kg of BOD removed. In a typical design, multiple filter cells are used so that one can be backwashed approximately once every 24 hours. The backwash is directed to a dirty washwater tanks and solids are removed and directed to thickening facilities. To meet the new federal requirement of 25: 25 BOD/TSS the BAF will be operated in a two stage series configuration.

Preliminary layouts indicate the BAF can fit on the McLoughlin site but there will be no space available for biosolids processing. If BAF is selected as the final process the tankage should be sized for the 2065 flow because the incremental increase is minor and it would be difficult to retrofit the plant on a tight site in the future.

BAF have been installed at Kingston and Windsor in Ontario and Canmore, Alberta. There are also a number of installations in the USA. Several suppliers can provide BAF process equipment.

At McLoughlin, because of the confined site the BAF is an ideal candidate but the filter tanks are quite deep which requires significant rock excavation thereby resulting in increased capital costs. The rock excavation will likely assist in reducing remediation costs. It should also provide good foundation conditions.

3.3.4 MBR Option

The previous consultants developed layouts for MBR at the McLoughlin site. For comparison purposes the current consulting team developed a layout and costing for an MBR treatment facility at McLoughlin. The MBR occupies a significant footprint and will infringe on the adjacent DND property. Although this technology is also viable the capital and operating costs are higher there is no need to produce a high quality discharge for disposal to ocean.

Schematic diagrams, design criteria and layouts of the BAF and MBR plants are appended to this report in Volume II.

3.4 Option 1B - Liquid Train Treatment

Treatment facilities for Option 1B will include the following:

- Saanich East: A 16.6 ML/day membrane activated sludge plant (MBR) with membrane capacity to handle up to 29 ML/d during wet weather conditions.
- A 92.8 ML/d ballasted sedimentation (i.e. Actiflo) wet weather treatment plant located at Macaulay Point to treat wet weather flows exceeding 2 x ADWF.
- A pumping station at Clover Point to transfer flows up to 2 x ADWF to Macaulay for re-pumping to a plant on the West Shore.
- A pumping station at Macaulay to pump flows to the West Shore.
- Forcemains and tunnels to convey flows to the West Shore.
- West Shore: A 216.6 ML/day conventional activated sludge plant providing secondary treatment up to 2 X ADWF with anaerobic digestion and resource recovery including biogas, heat recovery and phosphorus recovery.

The West Shore secondary plant would be located in the area of south Colwood recommended by the PRT. There is sufficient space to place the plant within the tailings portion of the gravel pit which will be reclaimed during installation of plant tankage. There is adequate space on site to accommodate biosolids treatment, resource recovery and liquid train facilities which provides significant operational advantages.

3.5 Option 1C - Liquid Train Treatment

Under Option 1C wet weather plants at Clover and Macaulay are eliminated and flows up to 4 times ADWF are transferred for primary and secondary treatment on the West Shore. Treatment facilities for option 1C will include the following:

- Saanich East - North Oak Bay: A 16.6 ML/day membrane activated sludge plant (MBR) with membrane capacity to handle up to 29 ML/d during wet weather conditions.
- A pumping station at Clover Point to transfer flows up to 4 x ADWF to Macaulay for re-pumping to a plant on the West Shore.
- A pumping station at Macaulay to pump 4 x ADWF flows to the West Shore from Macaulay and Clover Point Catchments.
- Forcemains and tunnels to convey flows to the West Shore.

- West Shore: A 216.6 ML/day conventional activated sludge plant providing secondary treatment up to 2 X ADWF with anaerobic digestion and resource recovery including biogas, heat recovery and phosphorus recovery. Primary treatment is provided for up to 4 x ADWF at the West Shore.

The West Shore secondary plant would be located in the area of south Colwood recommended by the PRT. There is sufficient space to place the plant within the tailings portion of the gravel pit which will be reclaimed during installation of plant tankage. There is adequate space on site to accommodate biosolids treatment, resource recovery and liquid train facilities which provides significant operational advantages.

Section 4 Biosolids Design for Options 1A, 1B, 1C

4.1 Representative Biosolids Treatment Technology

This section describes how biosolids are assumed to be managed for the three plant configuration options 1A, 1B and 1C including information on the processing technologies, integrated resource management opportunities, and beneficial uses of biosolids. It is noted that a biosolids management plan is currently being prepared for CRD. The principal biosolids treatment technologies assumed for this assessment include thermophilic anaerobic digestion, co-digestion with other organic substrates such as fats, oils, and grease (FOG) and food waste; thermal drying to stabilize wastewater biosolids and produce a biosolids product for beneficial reuse; gas scrubbing to produce pipeline quality biomethane fuel; and struvite precipitation from dewatering centrate to produce a saleable fertilizer. At the pre-design stage of this project the final biosolids strategy could change depending on site availability and market analysis for biosolids products. The representative technologies selected for the biosolids treatment process are shown schematically in **Figure 4.1**:

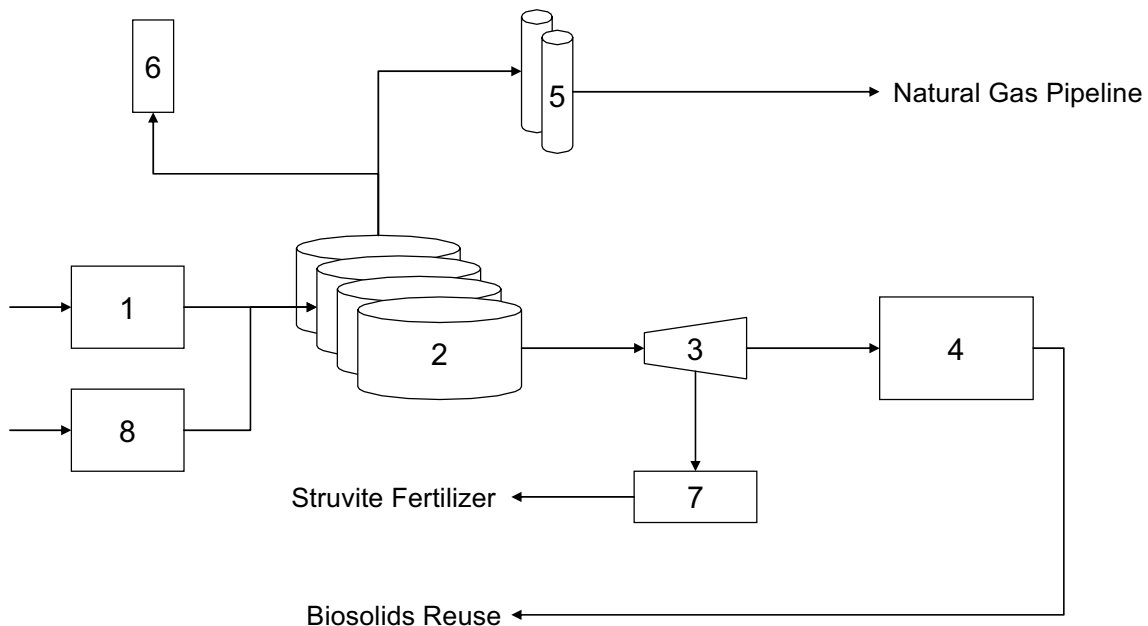

Figure 4.1 – CRD Biosolids Process Flow Schematic.

1. Screening – Co-thickened primary and secondary sludge is screened to remove visible foreign material.
2. Thermophilic anaerobic digestion – Anaerobic digestion of thickened solids at thermophilic temperatures to reduce solids and pathogens and enhance production of usable biogas.
3. Dewatering – Dewatering of digested biosolids through centrifugation.
4. Thermal drying – Removal of moisture from biosolids with a belt dryer and produce a product that can be used as a fuel or fertilizer.
5. Gas Scrubbing – Digester biogas would be cleaned and scrubbed to pipeline quality and sold to the local gas utility.
6. Flare – Complete combustion of any waste gas streams.
7. Nutrient Recovery – A nutrient recovery process would precipitate out struvite from the centrate. Struvite can be sold as a fertilizer product.
8. Organic Waste Receiving – Certain organic wastes from solid waste streams or other commercial or industrial sources would be screened and added to the digestion process to increase digester gas production.

4.2 Integration of Biosolids and Solid Wastes

There are several opportunities for integration of biosolids with solid waste processing and disposal. The integration of appropriate organic wastes at the biosolids facility can increase biogas production and energy recovery from the digestion process while reducing the volume of wastes sent to the regional landfill. The CRD has a proposed organics ban date of May 2012 for organics to the landfill, and the current Solids Waste Strategic Plan has a short term goal of 60 percent diversion of organic wastes from the landfill by 2013 and 90 percent diversion by 2020. To support these goals, it is proposed that CRD implements co-digestion as part of its standard operating procedure for wastewater solids processing and handling at the new wastewater treatment facilities for CRD. Combining fats, oils and grease or “FOG” (including brown grease and some yellow grease) with wastewater solids loaded to the digester will greatly increase biogas production. The biosolids facilities for each design option (1A, 1B, and 1C) should be capable of receiving FOG and other organic wastes at an organic waste receiving station. A screening process at the organic waste receiving facility will ensure organic wastes added to the biosolids treatment process do not contribute any undesirable inert material to the final biosolids process.

The biosolids facilities have been configured and sized to be capable of receiving a significant fraction of available organic wastes from the community. This includes an additional 10 percent volume of anaerobic digester tankage for organic waste substrate addition, adequate capacity

for receiving the majority of FOG in the CRD. Additional biogas production, beyond FOG addition, could be achieved through the addition of some food wastes from residential and commercial sources and/or liquid organic wastes from other industries in the region. The addition of food wastes to the biosolids digesters that require minimal processing would further reduce the organics load to the landfill, where currently food wastes contribute approximately 20 percent of the material entering CRD's landfill. Additional receiving and processing considerations are required to integrate food waste with Biosolids processing. Contaminants such as broken glass and eating utensils must be carefully removed, for example, and the separated food waste solids must be slurried or pulped prior to digestion. These provisions add complexity, space requirements and cost to a wastewater treatment plant solids processing facilities. A potential appropriate site for food waste processing is the CRD regional landfill. (REFER TO PRT COMMENTS).

Another possible integration option is combining dried biosolids with combustible solid waste in a regional waste-to-energy facility. Drying is included in the representative biosolids processing facilities evaluated in this report. However, the assumption is made that the dried product is used as cement kiln fuel. Feasibility of a regional waste-to-energy facility is being evaluated independently by the CRD and other potential participating agencies.

A third possible integration opportunity would be co-locating biosolids processing facilities at the Hartland Road landfill. This could enhance co-digestion and open up alternatives such as landfill biocells, combining digested sludge with solid waste in a specially designed landfill cell to enhance gas production.

These options of a combined waste –to-energy facility and of co-location of biosolids facilities at Hartland Road landfill will be evaluated as part of a future Biosolids Master Plan. For this study, biosolids are assumed to be processed at the wastewater treatment plant or, in the case of Option 1A, at a separate biosolids processing site.

4.3 Site Constraints

Although there are numerous criteria that influence the acceptability of a site for biosolids facilities, the principal site constraint is availability of adequate room for all required processes. At the McLoughlin site for Option 1A, little land is available for the location of biosolids facilities. Preliminary site layouts indicate adequate space is available for the required liquid treatment facilities, but space for a complete biosolids facility is unavailable unless additional land is purchased. For this study, an upper Victoria Harbour site was selected as a representative site for costing and evaluation. At the West Shore site locations for Options 1A, 1B, and 1C, sufficient land is available for the co-location of biosolids treatment facilities with the liquid stream treatment processes.

4.4 Biosolids Facilities Design Criteria

The biosolids facilities design criteria used for the evaluation of Options 1A, 1B, and 1C are presented in detail in Volume II - Drawings.

4.5 Regional Energy Centre (Biosolids) Facility

The concept of a regional biosolids processing facility involves all processing of biosolids for the entire region at a single site. A regional biosolids facility would provide wastewater solids stabilization and allow for integration of organic solid wastes by siting separate digesters in the same location. In addition, heat recovery from the treatment plant effluent could be used to provide process heat to the biosolids facility. Regionalization of the biosolids facility could improve economy of scale provided by larger processing facilities and the efficiency of centralized resource recovery. The location of the biosolids facility would need to be coordinated with wastewater treatment, recovery of heat, delivery of organic solid waste, and transportation of dried biosolids fuel/fertilizer. For this evaluation, a regional biosolids processing facility is included under Options 1B and 1C, where it would be co-located with liquid stream facilities at the West Shore site. In Option 1A it was assumed that separate biosolids processing would be provided for the liquid stream capacity of plants at McLoughlin Point and the West Shore. As discussed above, sufficient space is not available at McLoughlin for biosolids processing so a separate biosolids facility was assumed located at a representative upper inner harbour site. This site is also constrained in space and could provide capacity for the McLoughlin sludge loads, but not for those at West Shore. Alternatives for regional biosolids facilities for Option 1A could include locating all biosolids facilities for all loads at the West Shore, at Hartland Road landfill, or at some other as yet unidentified site.

4.6 Resource Recovery from Solids Processing

Resources recovered from solids processing could include biogas, a soil amendment product, and a dried fuel product. The biogas produced from digestion would be scrubbed to natural gas quality and sold to the local natural gas utility. The soil amendment product would have a variety of potential beneficial uses, including use as a fertilizer for local willow coppice, a blended topsoil fertilizer product for sale to the local communities, and as a biocell additive to enhance organic waste destruction and energy recovery at the landfill. Also, dried biosolids can be sold as a fuel to industries burning solid fuel, such as cement kilns, paper mills, and energy facilities.

A more detailed explanation of biosolids resource recovery processing and utilization is included in Section 6.0.

4.7 Description of Solids Treatment for Option 1A

Under Option 1A, the solids treatment facilities are split between two locations, West Shore and McLoughlin. As detailed in Section 2.0, Option 1A includes a secondary treatment facility at West Shore and McLoughlin. A solids treatment facility at West Shore would be located adjacent to the secondary treatment facility. Solids processes at West Shore would include thermophilic anaerobic digestion, thermal drying, biogas scrubbing to pipeline quality, and integrate FOG waste. The McLoughlin secondary treatment facility is located adjacent to the outer Victoria Harbor. Due to site constraints, solids processing would be located separate from the secondary treatment facility. Solids produced at the McLoughlin secondary treatment facility will be thickened and pumped to the biosolids facility for stabilization and further processing. The biosolids facility for McLoughlin would be located adjacent to the Upper Victoria Harbour with a potential site and would utilize thermophilic anaerobic digestion, thermal drying, biogas scrubbing to pipeline quality, recovery of phosphorous, and the process will integrate solid wastes by providing for co-digestion of other organic wastes.

4.8 Description of Solids Treatment for Option 1B

The solids treatment facility for Option 1B would be located at the West Shore site adjacent to the secondary treatment facility. The facility would include thermophilic anaerobic digestion, thermal drying, biogas scrubbing to pipeline quality, recovery of phosphorous, and the process will integrate solid wastes by providing for co-digestion of other organic wastes.

4.9 Description of Solids Treatment for Option 1C

Similar to Option 1B, the solids treatment facility for Option 1C would be located at the West Shore site adjacent to the secondary treatment facility. The biosolids facility would include thermophilic anaerobic digestion, thermal drying, biogas scrubbing to pipeline quality, recovery of phosphorous, and the process will integrate solid wastes by providing for co-digestion of other organic wastes.

Section 5 Conveyance Systems

5.1 Description of Existing Conveyance System

The existing CRD sewage collection system consists of two major catchment areas: Clover Point and Macaulay Point. The system utilizes several wastewater trunk mains to convey sewage through several municipalities and discharge to Clover Point and Macaulay Point pump stations, where the sewage is screened and discharged to the outfalls. The existing conveyance system is shown in **Figure 5.1**.

5.1.1 Clover Point Pump Station and Outfall

The East Coast Interceptor trunk main intercepts the Saanich Municipal trunk main, the Victoria City trunk main, and the Northeast trunk main at the Victoria Municipal Boundary prior to discharging to Clover Point pump station. The Clover Point service area includes several bypasses or overflow sewers located at Finnerty Cove, McMicking Point, Rutland Pump Station, Humber Pump Station, Harling Point Lift Station and Broom Road overflow. These bypasses or overflow sewers were designed to release the excess flow during extreme storm events.

The existing screens at Clover Point pump station screens solids greater than 6 mm and the solids are collected for transport to the landfill. The 1050mm diameter outfall extends 1154 m into the ocean at an average depth of 67m and terminates with a 196 m long diffuser. A 330 m emergency bypass outfall allows flows exceeding 4 x ADWF to be discharged to the outfall.

5.1.2 Macaulay Point Pump Station and Outfall

Several trunk sewers are serviced by the Macaulay Point Pump Station and Outfall. The Esquimalt/Western Communities trunk sewer collects flow from the municipalities of Colwood, Langford, View Royal and Esquimalt, and pumps the wastewater to Macaulay Point through the pump stations located at Lang Cove and Craigflower. The Northwest trunk main convey sewage from four Saanich Municipal subtrunk mains to Macaulay Point. The subtrunk mains collect sewage from North and West Saanich areas. A pump station located at Marigold lifts the sewage from the three northern Saanich subtrunk mains to the Northwest Trunk main, while a pump station located at Gorge Road pumps the sewage to Macaulay Point pump station and outfall.

The Macaulay Point outfall screens solids, plastics and floatable material larger than 6mm; the solids are transported to the landfill approximately twice weekly. The outfall extends 1.7km into the ocean at a depth of 60 m. The 1050 mm diameter outfall has a diffuser 150 m long with 28 ports.

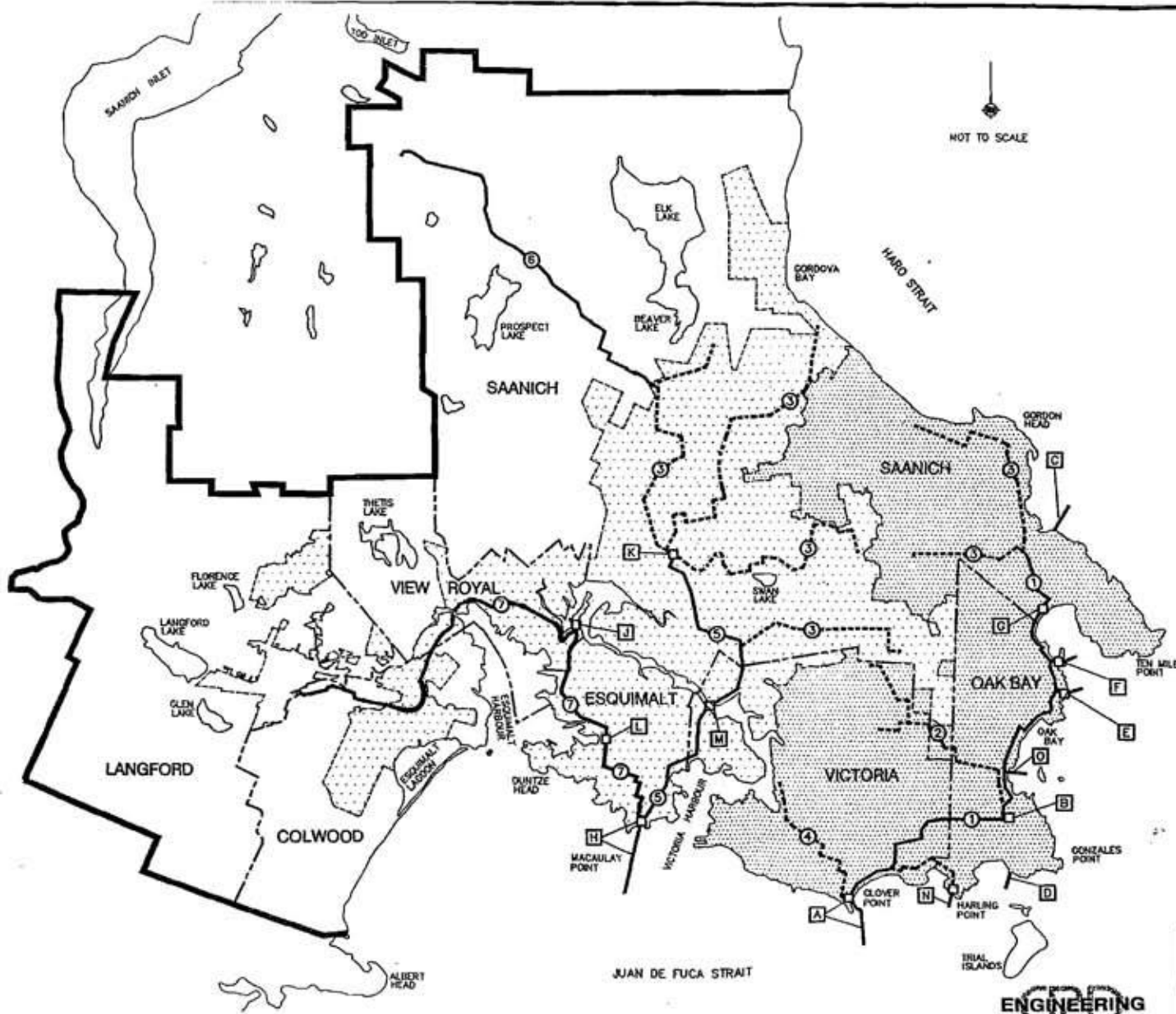

LEGEND

- LIQUID WASTE MANAGEMENT PLAN BOUNDARY
- MACAULAY POINT SERVICE AREA BOUNDARY
- ▨ CLOVER POINT SERVICE AREA BOUNDARY
- - - MUNICIPAL BOUNDARY

- ① EAST COAST INTERCEPTOR
- ② NORTHEAST TRUNK
- ③ SAANICH MUNICIPAL TRUNKS
- ④ VICTORIA CITY TRUNK
- ⑤ NORTHWEST TRUNK
- ⑥ HARTLAND LANDFILL LEACHATE PIPELINE
- ⑦ ESQUIMALT/WESTERN COMMUNITIES TRUNK SEWER
- A CLOVER POINT OUTFALL AND PUMP STATION
- B CURRIE PUMP STATION
- C FINNERTY COVE BYPASS OUTFALL
- D MCMICKING PT. BYPASS OUTFALL
- E RUTLAND PUMP STATION AND BYPASS OUTFALL
- F HUMBER PUMP STATION AND BYPASS OUTFALL
- G PENRHYN LIFT STATION
- H MACAULAY POINT OUTFALL AND PUMP STATION
- J CRAIGFLOWER PUMP STATION
- K MARIGOLD PUMP STATION
- L LANG COVE PUMP STATION
- M GORGE ROAD SIPHON
- N HARLING POINT LIFT STATION AND BYPASS OUTFALL
- O BROOM ROAD OVERFLOW

CORE AREA LIQUID WASTE MANAGEMENT PLAN
EXISTING WASTEWATER INFRASTRUCTURE
FIG. 5.1



5.2 Conveyance System Upgrading Requirements

The proposed CRD wastewater treatment options will require modifications of the existing conveyance system. The existing two sewage catchment areas will be converted to four catchment areas, namely East Saanich, Clover Point, Macaulay/McLoughlin Point, and West Sore, for servicing by the proposed wastewater treatment facilities or pumping stations located in the corresponding area. In order to maintain the existing sewage conveyance system as much as possible and accommodate treatment for future flow predictions to 2030 and 2065, three treatment options 1A, 1B and 1C have been identified as feasible for the CRD. Section 5.2.1 will cover the upgrades required for the conveyance system for all three treatment options. Sections 5.2.2 to 5.2.4 will review the three Options and their system components, flows and piping conveyance.

5.2.1 Upgrades Required for All Options

5.2.1.1 *Saanich East - North Oak Bay*

For all Options 1A, 1B and 1C, the new wastewater treatment plant for East Saanich is the same. The Saanich Municipal Trunk mains attached to the East Coast Interceptor will be intercepted and routed towards Finnerty Cove as a new secondary treatment plant is proposed for this area.

A new 900 mm diameter HDPE outfall in parallel to the existing 600 mm diameter outfall at a length of 1500 m will be required to discharge the treated effluent flows from the new plant. A sludge conveyance pipe will be required to transport biosolids from the new treatment plant to the East Coast Interceptor.

5.2.1.2 *Clover Point*

The redirection of the Saanich Municipal trunk mains resulting from the construction of the Saanich East - North Oak Bay wastewater treatment plant will remove tributary flows from the East Coast Interceptor and will reduce flows conveyed to Clover Point. As well, a reduction in wet weather volumes will reduce the flows from several bypass sewers along the Oak Bay shoreline.

A tunnel will be constructed under the harbour for the forcemain from Clover Point to McLoughlin / Macaulay Point. No upgrades to the outfall to accommodate future flows will be required for Clover Point.

5.2.1.3 *Macaulay Point*

No upgrades will be required to the Northwest trunk main and the Saanich Municipal trunk mains connecting to the Northwest Trunk. Under Option 1A, the Esquimalt/Western Communities trunk sewer system will be split between the McLoughlin/Macaulay Point

treatment plant and the West Shore treatment plant at a location near the Six Mile Road in View Royal. This will reduce the overall flow entering the McLoughlin/Macaulay treatment plant.

A new 1500mm diameter outfall at a length of 1800m will be required in parallel to the existing 1050 mm outfall to discharge the flows if a secondary treatment plant is constructed at McLoughlin site (Option 1A).

5.2.1.4 West Shore

The West Shore treatment system for all the options will require several new components including forcemains, tunnels, piping, pump stations and flow reversals in existing mains and new connections. The division of the Esquimalt/Western Communities trunk sewer at View Royal will require a new pump station that will intercept the flow and redirect it to the new wastewater treatment plant.

A new outfall will be constructed for the new treatment plant. The diameters of the outfalls will be 1500 mm, 2000 mm, and 2250 mm for Options 1A, 1B, and 1C, respectively.

5.2.2 Site Investigations

The wastewater conveyance system upgrades and locations for new installations will require investigation into environmentally sensitive areas, contaminated sites and archaeological assessment.

The location of the wastewater conveyance system along the shoreline and waterfront areas of Victoria, Esquimalt and Colwood may directly impact environmentally sensitive areas due to the location close to the shoreline. A foreseeable area of concern is Esquimalt Lagoon as it is a migratory bird sanctuary. Overall the conveyance will be within existing roadway right of ways so environmental impact is not expected to be significant. There is a potential to encounter archaeological sites along the alignment of new sewers and forcemains.

Contaminated sites may be an issue in some areas where installation of the conveyance system is required. Much of the infrastructure in Victoria and Esquimalt is aging and previous land uses may have affected the condition of the land since initial construction activities. It is recommended that investigation into contaminated sites is conducted.

An archaeological assessment is also recommended as several known locations within Ocean Boulevard and along the Colwood shoreline are present. Investigation of Dallas Road, Odgen Point, Esquimalt and the roads around Victoria Harbour should be investigated for archaeological significance.

5.3 Option 1A - Conveyance System

Option 1A system is composed of a secondary treatment plant for the East Saanich area, a wet weather station at Clover Point with a pump station transferring flow to McLoughlin Point secondary wastewater treatment plant, Macaulay Point pump station, as well as a new secondary wastewater treatment plant for the West Shore.

5.3.1 Saanich East - North Oak Bay WWTP

Wastewater from the Saanich Municipal trunk sewer in the Saanich East - North Oak Bay region will be redirected towards the Saanich East - North Oak Bay treatment plant possibly located in the Haro Woods area near Queen Alexandra Hospital. The proposed treatment plant will provide primary treatment for up to four times the average dry weather flow (ADWF) and of that, only 1.75 times ADWF will undergo secondary treatment. Any flow over four times the ADWF will bypass the system and will be discharged to the outfall; any flow over 1.75 times ADWF after primary treatment will also be discharged to the outfall. Flow greater than four times ADWF is generally high flow wet weather runoff. The East Saanich treatment plant will send biosolids from the treatment process into the East Coast Interceptor system to Clover Point.

5.3.2 Clover Point WWTP and Pump Station

In Option 1A the proposed Clover Point treatment plant will be a high rate wet weather plant which only operates periodically. Flow from the East Coast Interceptor, Northeast trunk and Victoria City trunk mains will be intercepted at Clover Point. All incoming flow will be screened utilizing existing 6 mm screens; flow up to two times ADWF will be pumped to McLoughlin WWTP. The forcemain will be 900 mm in diameter and 4.6 km long. It will run along Dallas Road to Ogden Point, before it enters a tunnel in order to cross Victoria Harbour. The tunnel is discussed in more detail in section 5.8. Flow between two and four times ADWF will be treated in a new wet weather plant at Clover Point prior to discharging to the outfall. Flow above four times ADWF will bypass treatment and discharge after screening into the outfall for discharging into the Straights of Juan de Fuca.

5.3.3 Macaulay and McLoughlin Point WWTP

Flow from the Saanich Municipal trunk, Northwest trunk and the Esquimalt portion of the Esquimalt/Western Communities trunk main will be intercepted at Macaulay and McLoughlin WWTP. Flow in excess of four times the ADWF will bypass treatment and discharge out the Macaulay Point outfall. Flows at four times or less than the ADWF will be sent to the new McLoughlin WWTP and will join the flow that was pumped from Clover Point and undergo primary treatment. Biosolids collected at the McLoughlin WWTP will be pumped to the new biosolids treatment facility located potentially at BC Hydro site.

5.3.4 West Shore WWTP

The West Shore WWTP will accept flow from the Western portion of the Esquimalt/Western Communities trunk main and the existing sewage system in View Royal, Langford and Colwood. Flows entering the plant in excess of four times ADWF will bypass the treatment process and be discharged to a new outfall. Flows equal to or less than four times ADWF will go through the primary treatment process and of this flow, two times or less the ADWF will undergo secondary treatment prior to discharge through the West Shore outfall. Biosolids collected after primary and secondary treatment will be treated on site at a biosolids treatment facility.

5.4 Option 1B - Conveyance System

Option 1B conveyance system has the same components for the East Saanich and Clover Point plants as described in Option 1A above. A wet weather WWTP at Macaulay Point providing primary treatment only and a pump station at Macaulay Point will divert flow to a new West Shore treatment plant.

5.4.1 Saanich East - North Oak Bay WWTP

Refer to Section 5.3.1 for description of Saanich East - North Oak Bay WWTP and conveyance system.

5.4.2 Clover Point WWTP and Pump Station

Refer to Section 5.3.2 for description of Clover Point WWTP and Pump Station.

5.4.3 Macaulay Point WWTP and Pump Station

As described in Section 5.3.3 above, flow from the Saanich Municipal trunk, Northwest trunk and the Esquimalt portion of the Esquimalt/Western Communities trunk main will be intercepted at Macaulay and McLoughlin WWTP. Option 1B will allow flow in excess of four times ADWF to bypass treatment and discharge out the Macaulay Point outfall. Flows between two and four times the ADWF will undergo primary treatment at Macaulay Point prior to discharge at the Macaulay Point outfall. Flows less than two times ADWF and the flow from Clover Point pump station will be pumped to the West Shore WWTP for treatment. Biosolids collected from the primary treatment process will be pumped to the West Shore treatment plant. Approximately 8.1 kilometers of 1200 mm diameter pipe will be required to carry the flow from Macaulay Point to the West Shore treatment plant. Two kilometres of the distance to the West Shore plant will be tunneled under Esquimalt Harbour.

5.4.4 West Shore WWTP

Option 1B for the West Shore WWTP will intercept flow from the West Shore catchment area and join with the flow from Macaulay Point pump station. Flow in excess of four times ADWF from the West Shore catchment area will bypass treatment and be discharged through the

outfall. Less than four times ADWF plus the Macaulay/McLoughlin flows will enter primary treatment. From primary treatment the flow is split so that greater than two times ADWF bypasses secondary treatment through the outfall. Two times ADWF and less will enter the secondary treatment process prior to discharge. Biosolids will be collected from primary and secondary treatment for treatment at an onsite biosolids treatment facility.

5.5 Option 1C - Conveyance System

Option 1C conveyance system has the same components for the East Saanich treatment plant as described in Option 1A and 1B above. A pump station at Clover Point will pump all flow up to 4 times ADWF to Macaulay Point, with any excess flows being screened and discharged to Clover Point outfall. Similarly a pump station at Macaulay Point will pump all flow up to 4 times ADWF to the West Shore for treatment, with any excess flows being screened and discharged to the outfall at Macaulay Point. The West Shore treatment plant will be designed to collect the flow from the Capital Regional District except the East Saanich WWTP for treatment at one location.

5.5.1 Saanich East - North Oak Bay WWTP

Refer to Section 5.3.1 for description of Saanich East - North Oak Bay WWTP and conveyance system.

5.5.2 Clover Point Pump Station

Flow from the East Coast Interceptor, Northeast trunk and Victoria City trunk mains will be directed to the Clover Point pump station. Flows in excess of four times ADWF will be diverted to the Clover Point outfall, flows less than this will be pumped to the Macaulay Point pump station. Similarly to Option 1A approximately 4.2 kilometers of 1200 mm diameter pipe will be required to deliver the flow from Clover Point to Macaulay Points, including the tunnel across Victoria Harbour. Refer to Figure 5.3 for Option 1C conveyance.

5.5.3 Macaulay Point Pump Station

Flows from the Northwest trunk and the Western portion of the Esquimalt/Western Communities trunk main will be split at the Macaulay Point pump station. Greater than four times ADWF will bypass the pump station and be discharged to the ocean. All flow less than four times ADWF will be combined with the flow from Clover Point pump station and pumped to the West Shore plant for treatment. The forcemain is 1800 mm in diameter and approximately 8.1 kilometres in length of which 2 kilometres is a tunnel under Esquimalt Harbour.

5.5.4 West Shore WWTP

The West Shore WWTP will treat all flows from the Capital Regional District in Option 1C. Flow from the West Shore catchment area will enter the plant and split so that flows in excess of four times ADWF will bypass the system to be discharged into the ocean. Flows less than four times

ADWF from the West Shore catchment area will join the flows pumped over from the Macaulay pump station and undergo primary treatment. The flow is split once again prior to secondary treatment so that greater than two times ADWF from both the West Shore and Macaulay/Clover will bypass secondary treatment and be discharged to the ocean. All flows less than twice ADWF from both the West Shore catchment area and the Macaulay/Clover pump station will undergo secondary treatment prior to discharging to the new outfall.

5.6 Marine Pipeline Crossing

Marine pipeline crossings at Victoria Harbour and Esquimalt Harbour will need to be evaluated as several options may be present, but along with each option there are several risk factors. Options 1A, B and C all require a pipeline passage through Victoria Harbour from Clover Point to McLoughlin and Macaulay Point. Options 1B and 1C require pipeline crossings through Esquimalt Harbour from Macaulay Point to the West Shore.

Options reviewed for the Harbour crossings include sinking and laying the pipe on the sea bottom and installing concrete mattresses on top or alternatively routing the pipeline around the harbour shoreline to stay clear of the traffic zones. The most feasible option reviewed is to tunnel under the harbours; this last option is discussed further in Section 5.8.

Several concerns that may be present for laying the pipeline on the seafloor are distance, marine traffic, underwater archaeological features and marine life. Large ships, such as the Coho present additional concerns to installing the pipe on the seabed. If large ships lose power while entering the harbour their emergency plan is to typically drop anchor. This poses an immediate threat to the pipeline if the anchor drags or lands on the pipe. Due to the nature of the pipe location and amount of flow passing through the pipes it is recommended that this risk be eliminated by tunneling under the harbour rather than laying pipe on the harbour seabed.

5.7 Outfalls

The CRD operates two sewage outfalls and several overflow outfalls as briefly described in section 5.1 and upgrades are required as described in Section 5.2. Preferable pipe material is HDPE for the Saanich East - North Oak Bay, Macaulay Point and West Shore outfalls. HDPE is not available in sizes over 1800mm diameter; therefore, the West Shore outfall will need to be epoxy coated steel pipe or consideration for two smaller pipes in HDPE material can be reviewed. HDPE is a preferable pipe material for outfalls because it is durable and can withstand large loads. As well HDPE pipe is relatively simple to float and sink into place during installation and does not require specific bedding material. If alternate pipe material other than HDPE is to be used then investigation into seabed conditions will need to be conducted.

Installation of the outfalls will require trenching and excavation of the inter-tidal beach section. Excavation and burial of the pipe will require an excavator working the tides from the beach and the pipe is to be covered with native materials. HDPE pipes will be weighted with conventional concrete ballasting (cylindrical or block shaped) weights for the float and sink procedure.

Additional weighting of the pipe with concrete mattresses may be required to further protect the installed pipeline from wave and ocean currents.

Depth of pipe installation will directly affect the risk factors and costs during construction. Depths below 50 m are standard and can be conducted with regular diving procedures. Depths greater than 50 m lead to expensive mixed gas diving and increased risk factors. The Macaulay Point outfall is currently at a depth of 60m. The new Finnerty Cove outfall and West Shore outfall may possibly be installed at a depth of 50 m or less, but will depend on ocean tides and seabed conditions.

Additional items to consider for outfall installation that are difficult to allow for are location details specific to site conditions, towing distance from joining site to installation site, wind, waves, tidal levels, alignment accuracy, vessel traffic in area (boats running over pipe) and project timing. Macaulay Point and the West Shore are located within busy shoreline areas (near the harbour or the Royal Road and direct pathways around the island) and it can be expected that ship traffic will have to be redirected while carrying out the float and sink method. Ship moorage/anchorage may also pose future risks if anchors graze the installed pipeline; therefore, concrete mattresses would be recommended in areas where ships anchor.

5.8 Tunnel Design Concepts

The options for the CRD sewage conveyance system require one tunnel for Option 1A and two tunnels for Options 1B and 1C. Option 1A requires a tunnel of approximately 0.9 kilometers from the Ogden Point shipyard area to the new treatment plant at McLoughlin Point.. Options 1B and 1C will require a second tunnel to run from outside of the DND base in Esquimalt to the Coberg Peninsula with a distance of approximately 2 kilometers.

Options for crossing the harbours include a horizontal directional drill (HDD) or an “utilidor” style conventional tunnel. The HDD method will install of two forcemains across the harbour using HDD techniques. HDD allows for installation of energy and municipal piping with limited impact to the surrounding area caused by construction. Installation time is estimated at 6 months for pipes using HDD method.

The conventional tunnel or “utilidor” will allow personnel passage through the tunnel, also allow installation of several pipes inside the utilidor and allow addition of piping in the future if necessary. At minimum 3 metre tunnel would be viable to service the CRD sewage system. The conventional tunnel requires a tunnel boring machine (TBM) and depending on soil types, hand tunneling may also be required. Installation time is approximated at 10 m per construction shift. The utilidor tunnel will require lighting and ventilation. Shafts will be required at either ends of the tunnel for access. A 6m diameter shaft shall be sufficient for access and shaft depths may exceed 35m depending on the quality of soil/bedrock. Investigations into soil and bedrock structure and feasibility of tunneling through the structure will need to be conducted. Depth of the tunnel below the sea bottom should be investigated; a preliminary estimated suggestion would be to drill the tunnel at least five tunnel diameters between the bottom of the

harbour and the top of the tunnel. Additional investigations should include risk assessment, environmental impact assessments, earthquake impact assessment and an archaeological impact assessment for both land and underwater at a minimum.

The final harbour crossing methodology will be determined following geotechnical investigation. For the purpose of cost estimate, conventional tunneling is assumed.

5.9 Pumping Facilities

As part of Options 1A, 1B and 1C major pumping facilities will be required. This section summarizes the facilities necessary for the project.

5.9.1 Saanich East - North Oak Bay Pump Station

A new pump station with two submersible pumps will be built for the East Saanich WWTP to lift raw sewage to the new headworks. The following design criteria have been developed for preliminary sizing of the facility.

- Firm pumping capacity (excluding standby pump): 68.7 ML/D for all options.
- Static lift: 8 m
- Approximate total dynamic head: 9.5 m
- Station discharge pipe size: 750 mm
- Approximate length of discharge line: 15 m
- Number of pumps to be installed: 2 (1 duty + 1 standby)
- Each pump capacity: 68.7 MLD
- Type of pump: Submersible solids handling centrifugal pump
- Preliminary pump selection: Flygt C3531, 135 HP
- Grinder: CDD4020-XD2.0 (Channel Monster)

The submersible pumps have been selected for cost effectiveness in capital and operating costs for the intended low lift service as compared with conventional dry-pit pumps. The pump station will be built with equipment (pump) access hatches open to the outdoor atmosphere with no superstructure above the wetwell. A portable truck crane would be used to remove the pump for servicing.

A grinder will be installed in a separate chamber immediately upstream of the pump station inlet. The grinder is intended to reduce the size of solids to prevent the pump from clogging.

5.9.2 Clover Point Pump Station

In Options 1 A and 1 B, the Clover Point Pump Station would be pumping the maximum dry weather flow (2 x ADWF) to Macaulay / McLoughlin WWTP, while the wet weather high flow would be bypassed to Actiflo for primary treatment prior to discharging to the ocean outfall. In Option C, the pump station is to pump all sewage flows (4 x ADWF) to Macaulay Pump Station for ultimate transfer to a regional plant on the West Shore. For the purpose of preliminary engineering, it is assumed that the existing station can be upgraded to meet the flow demand for Options 1A and 1B. Currently, the existing station is equipped with four vertical sewage pumps of 250 HP each with extended drive shafts connected to motors mounted on the top operating floor.

The existing station is also equipped with mechanical screens, which are adequately sized to serve the future CRD demand.

Under Option 1A and Option 1B, the upgrading requirement would include replacing two of the four pumps, while the remaining two units would be utilized for wet weather flow bypass pumping to the ocean outfall. The existing station piping would be modified to separate the two pumping functions: one for bypass pumping to the ocean outfall and the other for pumping to Macaulay.

In Option 1C, a new pump station is proposed to be built to handle the design flow as the existing station has structural and piping limitations to handle the required flow. For the purpose of preliminary engineering, it is assumed that the new pump station would be designed in similar configuration to the existing station that has separate wetwell and drywell compartments. All pumps would be installed in the drywell with motors located on the top main floor. A monorail hoist would be provided to handle the pump and motor equipment.

The following design criteria have been developed for preliminary sizing of the facility.

5.9.2.1 Options 1A and 1B – Clover Point Pump Station Upgrade

- Firm pumping capacity (excluding standby pump): 75.6 ML/d
- Static lift: -9 m (downhill pumping - backpressure sustaining valve required to keep the forcemain full and prevent pump runout)
- Approximate total dynamic head: 13 m
- Station discharge and forcemain pipe size: 900 mm
- Approximate length of discharge line (forcemain): 5100 m
- Number of pumps to be installed: 2 (1 duty + 1 standby)
- Each pump capacity: 75.6 ML/d

- Type of pump: Vertical sewage pump (similar to the existing)
- Preliminary pump size: 200 HP (based on Flowserve Model 24MN28C)
- The remaining two existing pumps would be kept for bypass pumping duty.

5.9.2.2 Option 1C – Clover Point Pump Station Upgrade

- Firm pumping capacity (excluding standby pump): 151.2 ML/d
- Static lift: -9 m (downhill pumping - backpressure sustaining valve required at Macaulay to keep forcemain full)
- Approximate total dynamic head: 11 m
- Station discharge and forcemain pipe size: 1200 mm
- Approximate length of discharge line (forcemain): 5100 m
- Number of pumps to be installed: 3 (2 duty + 1 standby)
- Each pump capacity: 75.6 ML/d
- Type of pump: Vertical sewage pump (similar to the existing)
- Preliminary pump size: 200 HP (based on Flowserve Model 24MN28C)

A new pump station is proposed to be built for this option as the existing station is considered too small for upgrading to meet the design flow.

The existing pump station would be kept for emergency bypass pumping duty.

5.9.3 Macaulay Pump Station

The proposed Macaulay Pump Station is designed to pump the influent sewage to either McLoughlin or West Shore WWTP. In Option 1A, the sewage would be pumped to McLoughlin WWTP, whereas in Option 1B and 1C, the sewage would be transmitted to West Shore WWTP.

The existing pump station is considered not fit for upgrading to handle the required flow in all options; therefore, a new pump station will be built. For the purpose of preliminary engineering, it is assumed that the new pump station would be designed in similar configuration to the existing station that has separate wetwell and drywell compartments. All pumps would be installed in the drywell with motors located on the top main floor. A traveling crane would be provided in each station to handle the pump and motor equipment.

The following design criteria have been developed for preliminary sizing of the pumping facility.

5.9.3.1 Option 1A (Pumping to McLoughlin)

- Firm pumping capacity (excluding standby pump): 276 ML/d
- Static lift: 15.5 m
- Approximate total dynamic head: 18 m
- Station discharge pipe and forcemain size: 1800 mm
- Approximate length of discharge line (forcemain): 1000 m
- Number of pumps to be installed: 3 (2 duty + 1 standby)
- Each pump capacity: 138 ML/d
- Type of pump: Vertical sewage pump (similar to the existing)
- Preliminary pump size: 500 HP (based on Flowserve Model 30MN33C)

The existing pump station would be kept for emergency bypass pumping duty.

5.9.3.2 Option 1B (Pumping to West Shore)

- Firm pumping capacity (excluding standby pump): 175 ML/d
- Static lift: 41 m (What site is this based on?)
- Approximate total dynamic head: 63 m
- Station discharge pipe (forcemain) size: 1200 mm
- Approximate length of discharge line: 8160 m
- Number of pumps to be installed: 2 (1 duty + 1 standby)
- Each pump capacity: 175 ML/d
- Type of pump: Vertical sewage pump (similar to the existing)
- Preliminary pump size: 2500 HP (based on Flowserve Model 24MN47A)

The existing pump station would be kept for emergency bypass pumping duty.

5.9.3.3 Option 1C (Pumping to West Shore)

- Firm pumping capacity (without standby pump): 350 ML/d
- Static lift: 41 m
- Approximate total dynamic head: 52 m
- Station discharge pipe size: 1800 mm
- Approximate length of discharge line: 8160 m
- Number of pumps to be installed: 3 (2 duty + 1 standby)
- Each pump capacity: 175 ML/d
- Type of pump: Vertical sewage pump (similar to the existing)
- Preliminary pump size: 1750 HP (based on Flowserve Model 24MN47B)

The existing pump station would be kept for emergency bypass pumping duty.

5.9.4 Pump Station Control

The pumps will be run by VFD's to adjust the pump output to closely match the influent while maintaining the self cleansing velocity in the discharge forcemain system. Advantages of VFD would also include smaller active wetwell volume (i.e. lower wetwell structural cost), lower pump starting (locked rotor) current, and reduced hydraulic upsurge during normal pump starting and stopping sequences.

The pumps will be controlled on the basis of sewage level in the wetwell measured by an ultrasonic level controller backed up with float switches for high and low level alarms. The pump station operating status including alarms will be centrally monitored.

5.10 SLUDGE CONVEYANCE

Sludge conveyance will be a key component of the Liquid Waste Management Plan and innovative practices for the Capital Regional District. The development of a sludge usage system will allow for the possibility of exploring district energy heating and cooling, composting, fertilizer, landfill and additional technologies for specific areas within the CRD. A Sludge Management Options Study previously conducted to explore the best practicable options for handling treated primary and secondary treated Biosolids from the Macaulay and McLoughlin Point wastewater treatment plant suggests that several options may be viable for the CRD.

The sludge conveyance system will transport sludge from the wastewater treatment plant to a designated location for use. Currently a location in Upper Victoria Harbour as a potential biosolids treatment and processing site. The sewage distribution management in Option 1 transports all sludge from East Saanich and Clover Point plants to McLoughlin and Macaulay

Point wastewater treatment plant. A conveyance system from McLoughlin / Macaulay Point to the selected biosolids site will be required for this option.

An approximation of the sludge production at McLoughlin and Macaulay Point is in the range of 29,430 Kg/day with one half of it solids at 1% and the second half solids at 3%, for an average of 2% solids overall. Transport of the solids will require a 150 mm - 200 diameter forcemain for a distance of approximately 4.5 kilometres.

Section 6 Resources from Wastewater

6.1 Water Reuse

There are opportunities for recovering resources from wastewater which are available from the liquid and biosolids treatment. Significant annual revenue can be achieved by CRD as shown below for year 2030 from previous studies for Option 1:

• Water Reuse (irrigation)	270 ML/yr,	revenue	\$195,000/yr
• Water Reuse (toilet flushing)	2340 ML/yr,	revenue	\$ 1,683,000 /yr
• Heat Extraction(district heating)	1.6x10 ⁶ GJ/yr,	revenue	\$ 867,000 /yr
• Dried Biosolids (fuel)	2915 tonnes/yr,	revenue	\$ 80,000 /yr
• Digester Gas (biomethane)	2.1x10 ⁶ m3/yr,	revenue	\$483,000 /yr
• Wood Chips(silvaculture)	3720kg/yr,	revenue	\$372,000 /yr
Total Revenue			\$3,632,000 /yr

A preliminary assessment indicated that similar levels of revenue will be available from the revised options 1A, 1B and 1C and are discussed in this section. The only exception is revenues from greywater reuse for toilet flushing which we believe was overly optimistic in previous estimates.

Under options 1A,1B and 1C the expectation for water reuse for irrigation is limited to the near vicinity of the WWTP plants and along the routing of effluent pipelines which will be established for extracted heat. The season for utilizing irrigation water in the Victoria area is limited to about 4 or 5 months during the summer. Customers in the near term are the golf courses which for an 18 hole course could utilize about 5 to 6 ML/day each as well as parks and institutional grounds. In the longer term individual lot irrigation could be achieved for new subdivisions, particularly on the West Shore should the new subdivisions include a “purple pipe” effluent distribution system. All reuse water will have to satisfy requirements of the MSR which will require disinfection. It is however noted that many golf courses in the CRD use well water and there would have to be an incentive for them to abandon use of this low cost water in favour of reclaimed effluent. Reclaimed effluent will provide some nutrient value and reduce reliance on fertilizers making use of this water more attractive to golf courses and others with large irrigatable lands.

In the development of resource recovery potential for Options 1A, 1B and 1C it is assumed that resource recovery processes will be added in a modular fashion to match the demand for resources. This approach reduces the risk of over building facilities before markets for resources are confirmed.

6.1.1 Option 1A – Water Reuse Potential

All of the secondary treatment plants in this option will include tertiary membrane filtration for at least a portion of the plant flow equivalent to the irrigation flow required for one or two golf courses. eg Saanich East - North Oak Bay, 17.2 ML/day (full plant flow); McLoughlin, 12 ML/day; West Shore, 6 ML/day. For **Saanich East - North Oak Bay WWTP** the University of Victoria grounds and surrounding parklands are the identified markets for irrigated water in the near term since effluent pipelines will be established there to provide extracted heat for UVic. There are several golf courses within a reasonable distance from the plant e.g. Cordova Bay, Cedar Hill, Uplands which could become customers. The Victoria Golf club is also on the route to Clover Pt but would probably be too distant for effluent delivery economically.

For **McLoughlin Point WWTP** there could be a market for high quality irrigation water on some of the parade grounds, PMQ residences and military building grassed areas adjacent to the plant. A major potential for effluent reuse from this plant would be the Provincial Legislative grounds and surrounding municipal parks en route along the waste sludge line to the biosolids management area at the BC Hydro site and the extracted heat pipelines planned to serve harbourside hotels and the Parliament buildings.

For the **West Shore WWTP** there would be a market for limited irrigation use on the plant grounds but there is an additional potential market to irrigate the surrounding land development for which this planning phase has targeted for heat extraction for about 1000 residences by 2030. Servicing long term green community development for 10,000 residences is not out of the question for the West Shore plant. Potential golf course customers could be Olympic View, Metchosin and Royal Colwood. The Royal Roads University grounds are also a potential customer for irrigation water.

A reasonable estimate of irrigation use for Option 1A for irrigated water usage for Option 1A is 1190 ML/yr for a potential revenue of \$856,000 per year because of the modified configuration of the system and our knowledge of the short term development which might occur in the West Shore gravel pit area. This analysis assumes incentive pricing of \$0.72/m³ for reclaimed effluent.

6.1.2 Options 1B and 1C

For these options there is no downtown secondary plant at McLoughlin Point only a plant at Saanich East - North Oak Bay and a large plant on the West Shore. The potential for irrigation water use at the University is similar to the original option 1 at about 420 ML/yr. There is also the same surrounding land development potential for irrigation water use on around the West Shore plant at about 410 ML/yr for an estimated total demand from these plants of about 830 ML/yr with a value of about \$ 598, 000 /yr.

For the distant future the size of the West Shore plant and potential development on the West Shore will provide major opportunities for irrigation use as green communities are encouraged in

Municipal Official Community Plans. It is possible that the future use of reclaimed water on the West Shore could exceed Option 1A.

6.2 Heat Recovery

The waste water treatment plants will require a large amount of heat for the digesters, drying and space heating. Heat recovery at the biosolids facilities would include recovery of heat from the hot digested sludge using sludge-to-water-to-sludge heat exchangers. The heat recovery system will minimize heating requirements of the raw sludge being fed to the digesters. The heat recovery system will recover approximately 50% of the heat required to heat the digestion system.

Additional plant heat demands would be provided by heat extraction from the effluent. A hot water heating loop will provide the heat required for each of these loads. Electrically powered heat pumps will supply heat to the hot water loop by using the available heat in the effluent discharged from the treatment plants, as described in Section 3.0. The heating of the digesters will be provided from the hot water heat loop, and the use of heat pumps will allow the use of biogas exclusively for biomethane under normal operating conditions. If electrical power supply to the plant is lost, the backup diesel generator will be able to provide enough power to the heat pumps to continue to heat the digesters. A biogas boiler rated at partial heat load will also act as a back up to the heat pumps.

Heat recovery will be accomplished by water source heat pumps extracting heat from treated effluent. Instead of exhausting into the ocean, the heat will be reclaimed. The heat pumps will supply approximately 70 C (160 deg F) water to the closed loop system. This temperature aligns with the temperatures required for the sludge plant processes and suited to building boiler temperatures and temperatures needed to generate domestic hot water. New heat pumps recently developed in Europe are now capable of producing product water of about 90 C (200 F), but are not as yet available for sale in North America due to electrical code listing requirements. We anticipate that by the time this project is implemented these units will be available in North America.

Focus has been placed on delivering heat to high demand areas and areas of future growth and development where a district heating system would have the most potential for success. These neighborhoods typically encompass government and commercial buildings, industry, health care and education which house boilers and/or existing district heating systems as at the University of Victoria.

The design analysis for options 1A, 1B and 1C has been completed in 3 separate “zones”: Saanich East - North Oak Bay/ University; McLoughlin/Downtown; West Shore/Royal Bay. Each zone will be designed to accommodate the special characteristics or needs of the area and maximize efficiencies and advantages.

At an incentive price estimate of \$10/GJ, annual revenue from the sale of heat generated from effluent could top \$9 million dollars by 2065. Annual costs to generate the heat and maintenance are estimated at approximately \$5.6 million leaving annual earnings from heat reclaim sales of approximately \$3.4 million in 2065 assuming there is a market for the captured heat. A realistic target may be 50% of the heat developed could be sold. Further market analysis may need to be conducted in the area of “incentive price”. Also affecting earnings from heat sales would be recent advances in the coefficient of performance of heat pumps and chiller systems. This could have significant effect on returns.

It is noted that studies are under way to assess the demand for reclaimed water and heat in the UVic and James Bay areas.

6.2.1 Saanich East - North Oak Bay Plant

This facility, in the initial design, will supply heat to the University of Victoria. Heated water will be transferred approximately 3.5 km (7km return loop) to the University’s existing district heating plant.

Option 1A, 1B and 1C: The Saanich East - North Oak Bay Plant will be a 16.6 ML/day operation in 2030 and 17.2 ML/day plant by 2065. If previous demand numbers calculated for the University of Victoria are correct, the entire saleable heat from winter and shoulder seasons of approximately 119,000 GJ/yr could be sold to a third party utility for \$1.2 million by 2065.

6.2.2 McLoughlin Plant

Heated water from the McLoughlin plant will provide heat to larger commercial buildings in James Bay and the downtown core. As well, the biosolids plant will be provided with heated water for their processes. The biosolids plant commands approximately 10% of the total heat available from the effluent flow at McLoughlin. The return distance of the heat pump loop is approximately 10 km. Economic advantages of conveying the sludge pipe and heating pipes in the same trench will be maximized.

Under Option 1A, supplying heat to the downtown core of Victoria, the entire heat capacity from the effluent of this 87.5 ML/d (ADWF) plant in 2065 could be sold if there is a market for this heat. The saleable heat of 588,000 GJ/yr could be sold to a third party for \$5,880,000 in 2065 assuming all heat is sold. It is likely more realistic to assume only 50 – 65% could be sold due to market conditions.

6.2.3 West Shore Plant

Demand was considered for the Royal Bay area only. This was due to long distances to other high demand areas on the West Shore such as the growing commercial areas in Langford. The demand in the Royal Bay zone will come from new developments wishing to take advantage of this “green” energy source. Conversion to district heating for new development areas is easier

to accomplish than for neighbourhoods with established infrastructure. This is a significant development opportunity.

Under Option 1A a total saleable heat of 257,000 GJ/day in the shoulder and winter seasons, \$2,570,000 of sales could be generated by 2065.

Option 1B and 1C with a 100.8 ML/day (ADWF) facility in 2065, a saleable heat of 349,000 GJ/day could command annual revenue of \$3,490,000.

6.2.4 Key Performance Indicator Summary

Potential net heat revenues could range from \$2.7 to \$3.2 million in the year 2030. This could increase if markets are available. Annual expenses for generating the heat and maintenance is approximately \$4.5 million (a loss of \$1.3 million annually). These revenues will fluctuate depending on the available market

If a more reasonable unit price of \$14 per GJ could be achieved, revenue from heat generated could be increased. Again market analysis would need to be conducted in this area to determine an “incentive price”. It is noted that only a certain percentage of the heat will likely be sold as it is unlikely that 100% sales could be obtained. Further work on the market for this heat should be completed.

6.2.5 Further Work

As previously discussed, the figures reported by the previous consultant team for heat demand in several areas appears overly optimistic. For example, if the University of Victoria requires 7,541 GJ/day or a reported yearly demand of 1,101,045 GJ per year by 2020, then at current energy prices their energy cost for heating alone would be over \$10,000,000 per year which is highly unlikely. All the potential effluent heat-reclaim at the Saanich East - North Oak Bay Plant would not completely satisfy this demand. More confirmation work needs to be done on the accuracy of the demand values and this will be done as part of the UVic Heat Recovery and Water Reuse Study.

The cost to connect to existing buildings and retrofit buildings has not been considered. Provincial incentives to assist in the cost of building connections and retrofits would encourage use of this resource.

There are also concerns to be addressed about reliability and consistency of heat delivered on clear cold January mornings. This issue also relates back to the accuracy of demand figures of the previous consultants. Large commercial buildings typically come on-line at 6am, after the night setback, to warm the building for the occupants arriving in the morning. This means that district heating systems would have to prepare for this ramp-up in demand at 4am – 5am. This however, occurs at the time of day when flows are at their minimum. There is a reverse time lag of what would be an ideal situation between demand and flow.

6.2.6 Seawater Based Heat Source

To increase potential sales revenue, counteract concerns about reliability due to the demand-flow time lag and to ensure capacity for future demand is secure, the obvious synergies to employing seawater based heat sourcing will be further investigated.

Seawater based heat sourcing is a relatively new technology which utilizes the heat potential in year round constant temperature ocean water. This option may be particularly beneficial where buildings are in close proximity to the harbour which has a readily available source of seawater.

When flows are low and demand spikes, ocean water could be either mixed with treated effluent or separately sourced to supplement the heat supply base. Also, if large quantities of sea water are used, the temperature drop of the effluent discharge could be minimized. This reduction in temperature provides two benefits: 1. increase in the coefficient of performance of the system and 2. Negation of any localized potential environmental impact of cold effluent discharge into the ocean.

6.3 Gas Recovery

The biogas produced by the digesters will be upgraded through the gas scrubbing system to high quality biomethane and injected into the natural gas pipeline. The biogas upgrading process has multiple stages of compression and purification. Hydrogen sulfide and bulk water are removed at the beginning of the process at low pressure. A scavenging media will remove hydrogen sulfide. The sweetened biogas is then compressed and run through a two stage Pressure Swing Adsorption (PSA) system to remove carbon dioxide, water and other impurities (e.g. siloxanes). The second stage PSA system upgrades the waste gas of the first stage PSA system to recover approximately 95% of the methane, and the combined process produces a fuel with an energy value equivalent to natural gas. A schematic of the biogas scrubbing system is shown in **Figure 6.1**.

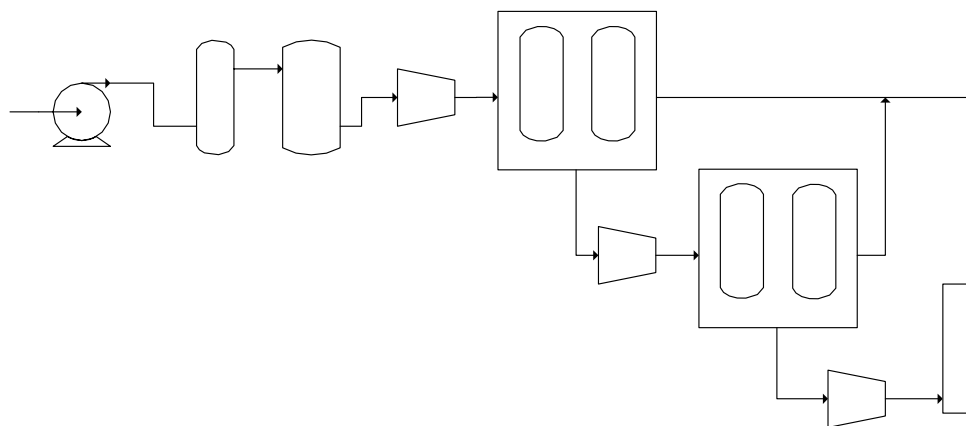

Figure 6.1
Biogas Scrubbing System Schematic

6.4 Phosphorus Recovery

Phosphorus is released as volatile solids are destroyed in the anaerobic digestion process (mesophilic and thermophilic). The released phosphorus is typically recycled to the liquid stream process for removal but can be recovered for beneficial reuse. Phosphorus is a non-renewable, irreplaceable resource (and as the elemental basis essential for all life forms) phosphates are a vital compound to key on for sustainable development, and for this main reason, good environmental stewardship suggests that phosphate should be recovered from waste streams for recycling, rather than continued mining of the existing (and now increasingly more low grade) and depleting phosphate rock. Phosphorus recovery from wastewater recycle streams offers an additional benefit of offsetting carbon dioxide equivalent emissions relative to conventional fertilizer manufacturing (CO₂ emissions associated with phosphate rock mining and transportation to market).

The consulting team assessed the potential for phosphorus recovery from anaerobic digester return streams using struvite crystallizers as part of the evaluation. Our initial evaluation indicates that CRD should be able to recover approximately 272 tonnes of struvite fertilizer product per year from anaerobic digester return streams regardless of the alternative selected (Options 1A, 1B, or 1C). The net revenue (sales revenue minus annual operating and maintenance costs) from phosphorus recovery via struvite crystallization is estimated at approximately \$54,000/year. The environmental benefits of phosphorus recovery will include the offset of approximately 2,700 tonnes of carbon dioxide equivalent emissions per year relative to conventional fertilizer manufacturing. All three options being considered – Options 1A, 1B, and 1C – offer essentially equal net revenue and environmental benefits. However, Option 1A would require CRD to construct two phosphorus recovery facilities (one 2 reactor facility at McLoughlin and single reactor facility on the West Shore) relative to constructing one 3 reactor facility on the West Shore at a lower capital cost as a result of economies of scale.

6.5 Biosolids Resources

The Biosolids program will maximize resource recovery and utilization while marketing diversely to provide reliability and redundancy. Diverse markets will also stimulate product demand and revenue recovery. For evaluating GHG impacts and benefits and revenues the following Biosolids markets allocations have been assumed:

- 50% Thermally dried biosolids for sale as fuel to cement kiln, pulp mill or private waste to energy facility.
- 20% Dewatered cake product used for a manufactured topsoil product.
- 10% Dewatered cake to willow coppice (biomass) pilot project.
- 20% Dewatered cake to landfill biocell for co-stabilization with general municipal solid waste.

6.5.1 Dried Fuel Product

Energy recovery is a productive end use option for biosolids. In cement manufacturing, the biosolids are burned as fuel and the ash is used for raw material substitutes. The heating value of dried biosolids is typically 18,000 kJ/kg. This is only slightly lower than soft coal, which typically have a heating value of 26,000 kJ/kg (Forgie et al, 2008). Dried biosolids fuel products provide an alternative renewable energy source to fossil fuels such as coal. The noncombustible components of solids can provide the chemical components (CaO, SiO₂, Al₂O₃, and Fe₂O₃) which are traditionally supplied by lime, clay and iron ore. The replacement of these materials can offset transportation costs of bringing these raw materials to the cement plant. Other industries such as paper mills and waste to energy facilities can also benefit from using a dried biosolids product as fuel.

6.5.2 Top Soil Amendment

Class A Biosolids can be utilized as an ingredient in manufacturing topsoil. The CRD currently has their own soil amendment called Pengrow and this demand for this product has been good. Similar products produced in the Okanagan at Kelowna and Penticton have been very successful. Another notable example is the City of Tacoma, which mixes biosolids with sawdust and sand to make “TAGRO” (<http://www.cityoftacoma.org/Page.aspx?hid=688>). TAGRO has been used successfully in the local community for nearly 20 years. Biosolids topsoil products like TAGRO improve soils similarly to finished compost. These products are not marketed as fertilizers, but rather are soil amendments which improve tilth, infiltration, water holding capacity, and general productivity. On depleted soils or in areas where topsoil has been disturbed such products can be particularly valuable. Notable examples include new construction, highway medians, and landscaping projects. Biosolids and topsoil products also have a highly successful record in reclamation projects on disturbed land like mine tailings and landfill cover. Metro Vancouver’s “Nutrifor” program (<http://www.metrovancouver.org/services/wastewater/nutrifor/Pages/default.aspx>) provides many documented examples. The goal for all of these programs is to boost soil organic matter to levels comparable to productive soil (approximately 3-5% in the top 15 cm). While organic matter is a primary component of alluvial soils in river valleys, it is lacking many other areas. Soil amendments can correct this condition and provide long-lasting improvement to plant growth.

6.5.3 Willow Coppice

Application of biosolids provides many benefits to the production of short rotation woody crops (SRWC) for biomass production. Substituting inorganic N fertilizer with biosolids can increase biomass production as well as decrease the operational costs (Heller et al 2003). A secondary benefit is that the organically bound fraction of nutrients in biosolids are released slowly making them available far longer into the SRWC rotation when additional amendment application is prohibitive (Heller et al 2003).

High density SRWC can be harvested every one to four years for biomass. The harvested wood is chipped and dried to substitute for fossil fuels in energy production (Vande Walle et al 2007). The amount of carbon released during cultivation and transport of trees is roughly equal to the carbon input into the soil (i.e. decomposing roots and stumps remaining from the partial harvest) (Vande Walle et al 2007). Therefore, burning wood chips will reduce emission of greenhouse gases and help achieve a negative carbon footprint.

6.5.4 Biocell

A biocell is an innovative closed loop landfill reactor system that is operated in two stages where biosolids are mixed with municipal wastes and placed in a landfill with gas collection equipment. In the first stage, the bioreactor mimics an anaerobic digester to capture biogas released from decomposing biosolids mixed with solid wastes. The captured gas can then be converted to power. In the second stage, air is injected into the solid waste to promote an aerobic composting environment (Hettiaratchi et al 2007). After a period of time the compost can be removed from the biocell. A biocell is particularly beneficial in this design as a backup to receive any overflow solids when seasonal demand is low or if complications arise in the solids dryer. A biocell has been constructed and operated successfully at the City of Calgary.

Potential revenues from the biosolids stream are summarized in **Table 6.1**.

6.6 Regional Energy Centre

As part of the wastewater planning for the CRD a separate biosolids master plan is being completed. This master plan will consider opportunities for integration of biosolids and solid waste activities within the CRD. Depending on the final location of biosolids treatment facilities there is an opportunity to develop a regional energy centre which would integrate biosolids and the organic fraction of solid wastes. This facility could accept fats, oil and grease to enhance digester gas production. Biomethane production could be used for fueling vehicles and sale to the gas transmission system. This concept will be further developed in the biosolids master plan.

Table 6.1
Summary of Biosolids Facility Potential Revenue Production

Revenue Stream	Unit	Option 1B and 1C	Option 1A McLoughlin	Option 1A West Shore
Biomethane				
Digester Gas Production ¹	m ³ /day	21,100	16,900	3,400
Average Biomethane Produced ²	N m ³ /hr	400	320	80
Unit Biomethane Value ³	\$/GJ	\$11.46	\$11.46	\$11.46
Potential Revenue	\$/yr	\$1,565,000	\$1,252,000	\$313,000
Dried Sludge Fuel				
Digested Biosolids Produced	kg/day	14,950	12,000	3,000
Assumed Fraction of Biosolids Sold as Fuel	%	50	50	50
Unit Dry Biosolids Value ^{4,5}	\$/GJ	\$1.68	\$1.68	\$1.68
Potential Revenue	\$/yr	\$82,000	\$66,000	\$16,000
Tipping Fees				
Average Daily FOG Delivery ⁶	L/day	69,000	55,200	13,800
Tipping Rate ⁷	\$/L	\$0.07	\$0.07	\$0.07
Number of Trucks ⁸	Trucks/day	10	8	2
Potential Revenue ⁹	\$/yr	\$1,763,000	\$1,410,000	\$353,000
Blended Soil Amendment Product				
Digested Biosolids Produced	kg/day	14,950	12,000	3,000
Assumed Fraction of Biosolids Sold as Blended Soil Amendment	%	20	20	20
Average Blended Soil Amendment Produced ¹⁰	m ³ /day	36	29	7
Average Sale Price of Blended Soil Amendment ¹¹	\$/m ³	\$11.00	\$11.00	\$11.00
Potential Revenue ¹²	\$/yr	\$42,000	\$23,000	\$6,000
Wood Sales from Willow Coppice				
Assumed Willow Coppice Area ¹³	ha	81	65	16
Wood Production Rate ¹⁴	Dry tonnes/yr	1222	978	244
Energy Available from Wood ¹⁵	GJ/yr	20,200	16,200	4,000
Unit Wood Value ⁴	\$/GJ	\$1.68	\$1.68	\$1.68
Potential Revenue	\$/yr	34,000	27,000	7,000
Struvite	\$/yr	54,000	54,000	54,000
Total	\$/yr	\$3,540,000	\$2,833,000	\$749,000

¹ Annual average gas production with FOG addition, 30% by VS load.

² Biomethane produced assumes 95% recovery of biogas methane and 95% equipment availability to produce a final gas product of 98% methane and 2% carbon dioxide.

³ Price of biomethane based on 80% of natural gas price for Vancouver Island (\$14.33/GJ).

- 4 Price of biosolids fuel/wood fuel is based on 80% of average cost of equivalent energy of coal (\$2.10/GJ).
- 5 Energy value of dried biosolids, 18,000 kJ/kg.
- 6 Excess capacity in digester assumed to be used to accept FOG, assuming approximately 80% capture of FOG available in CRD.
- 7 Tipping fee assumed equal to septage receiving tipping fee at Metro Vancouver's Iona Island WWTP.
- 8 FOG truck volume assumed is 10 m³ and truck number calculated assuming trucks deliver FOG at ¾ of capacity (7.5 m³/truck).
- 9 Revenue for accepting FOG assumes receiving substrate 365 days per year.
- 10 Biosolids cake is blended with 1/5 sand and 2/5 sawdust by volume. Assumes specific gravity of sludge, sand, and sawdust is 1.0, 1.7, and 0.25, respectively. Product volume will expand by approximately 15% after blending.
- 11 Sale price for blended soil amendment product assumes same blend and price as Tagro, produced by Tacoma, Wa., CTP.
- 12 Revenue includes sale of product less cost of sand and sawdust at \$12.60 and \$16.10, respectively.
- 13 Assumes a solids application rate of 200 lb N/acre, where biosolids is 3.3% N.
- 14 Assumes a production rate of 15,000 kg/ha/yr
- 15 Energy value of willow wood is 19,000 kJ/kg, and 13% of the energy value is used to evaporate moisture.

Section 7 Carbon Footprint Analysis

A carbon footprint analysis was performed as a part of the evaluation of the environmental impacts of the three alternatives, Options 1A, 1B, and 1C. A carbon footprint measures the amount of greenhouse gases (GHG) released or stored as a result of a process or activity. To separately account for direct and indirect emissions, GHG inventory protocols categorize direct and indirect emissions into “scopes” as follows:

- **Scope 1:** All direct GHG emissions (with the exception of direct CO₂ emissions from biogenic sources).
- **Scope 2:** Indirect GHG emissions associated with the consumption of purchased or acquired electricity, steam, heating, or cooling.
- **Scope 3:** All other indirect emissions not covered in Scope 2, such as emissions resulting from the extraction and production of purchased materials and fuels, transport-related activities in vehicles not owned or controlled by the reporting entity (e.g., employee commuting), outsourced activities, waste disposal, etc.

This analysis included Scope 1, 2, and 3 emissions associated with the alternative design options. The emissions associated with the entire wastewater treatment process were evaluated (i.e., liquid stream treatment, solids processing and disposal and resource recovery) to the extent feasible at this preliminary design analysis stage. In addition, a limited analysis of the embodied emissions associated with the concrete and steel used in the construction of the new wastewater treatment facilities was also included. **Figure 7.1** illustrates the emission scope categories.

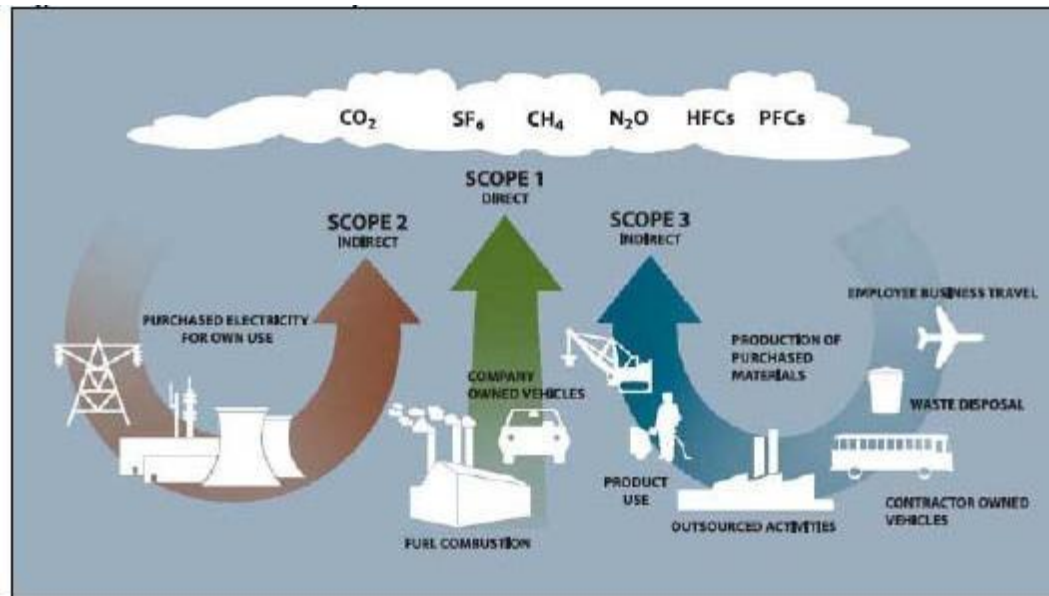

Source: WRI/WBCSD *GHG Protocol Corporate Standard*, Chapter 4 (2004).

7.1 Basis of Methodology

Carbon footprint analysis is a relatively new method of quantifying environmental impacts. Therefore, the analysis methodologies can vary widely. The major sources for this analysis include Associated Engineering (AE) report previously prepared for this project as well as relevant scientific literature. Where possible, consistency with the previous consultant's reports was maintained. However, the carbon footprint analysis was altered to comply with the new design criteria and assumptions.

The three GHGs relevant to wastewater treatment plant operation are carbon dioxide (CO₂), methane (CH₄), and nitrous oxide (N₂O). The direct and indirect emissions and offsets of these GHGs associated with the alternatives are included in the carbon footprint analysis.

- Carbon Dioxide: CO₂ enters the atmosphere by burning carbonaceous substances such as fossil fuels (oil, natural gas, and coal), solid waste, and trees, and as a byproduct of chemical reactions (e.g., the manufacture of cement). CO₂ is also removed from the atmosphere (or "sequestered") when it is absorbed by plants or stored in the soil as part of the biological carbon cycle.
- Methane: CH₄ is emitted during the production and transport of coal, natural gas, and oil. CH₄ is also produced from the anaerobic digestion of waste at wastewater treatment facilities, through livestock, and by the decay of organic waste in municipal solid waste landfills.

- Nitrous Oxide: N₂O is emitted by agricultural and industrial activities, combustion of fossil fuels and solid waste and secondary biological nutrient removal wastewater treatment processes.

In addition to the above three GHGs, hydrofluorocarbons (HFCs), perfluorocarbons (PFCs), and sulfur hexafluoride (SF₆) are also GHGs regulated under the Kyoto Protocol. These GHGs are not expected to be emitted in significant quantities from the wastewater treatment process and estimates of emissions of these GHGs associated with the alternative design options are not currently available, therefore these GHGs are not included in the analysis.

Once greenhouse gases are emitted into the atmosphere, they absorb and re-radiate heat with varied levels of effectiveness. The global warming potential (GWP) quantifies the contribution of each gas over a specific time interval in terms of CO₂. The GWP of CO₂, by definition, is 1. The 100-year GWP values of CO₂, CH₄, and N₂O are shown below, based on the 2001 Intergovernmental Panel of Climate Change (IPCC) Third Assessment Report.

- CO₂ GWP = 1 equivalent kilogram of CO₂
- CH₄ GWP = 23 equivalent kilograms of CO₂
- N₂O GWP = 296 equivalent kilograms of CO₂

The results of this carbon footprint analysis are reported in equivalent tonnes of CO₂. A summary of the emissions factors used to calculate the GHG emissions associated with the alternatives is provided in Table 7-1. A list of guiding assumptions is also provided below.

Greenhouse gas emissions can occur from anthropogenic or biogenic sources. Anthropogenic emissions are produced by human activities that remove sequestered carbon from the earth's crust and release it to the atmosphere (e.g., through the burning of fossil fuels). Biogenic carbon occurs in plants and animals that intake and dispense of carbon cyclically. Biogenic sources do not increase the amount of greenhouse gases in the atmosphere, but merely represent the "natural" cycling of carbon. Therefore, emissions of biogenic CO₂ are generally not accounted for in greenhouse gas inventories for wastewater treatment. In fact, biogenic carbon sources can be considered an offset when utilized in place of an anthropogenic source (for example, when using biogas from a wastewater treatment process as a fuel source in place of natural gas).

The carbon footprint analysis was performed using estimates for the operation of the facilities in the design year of 2030. The construction-related GHG emissions were analyzed for a single year. The purpose of this carbon footprint analysis was to evaluate if there are significant differences in the GHG emissions associated with each design alternative. Therefore, a single year analysis of the operation-related GHG emissions and a single year analysis of the construction-related GHG emissions was considered appropriate for the comparative alternative evaluations. A full lifecycle carbon footprint analysis combining the construction-related GHG emissions and the lifecycle operation-related GHG emissions was not performed at this time.

As additional detailed design data is developed, a full lifecycle carbon footprint analysis could be conducted in the future.

**Table 7.1
 Greenhouse Gas Emissions Factors**

Components	Literature Value	Units	Conversion to tonne CO ₂	Units	Source
Construction					
<i>Concrete</i>	0.3	ton CO ₂ e/m ³	0.272154	tonne CO ₂ e/m ³	Flower & Sanjayan.2007
<i>Steel (re-bar, piping, equipment)</i>	0.0032	ton C/ton product	0.0032	tonne C/tonne product	EPA, 2003
<i>Excavation (diesel fuel emissions)</i>	0.1	gal/m ³	0.000981	tonne/m ³	Wilson, personal communication
Conveyance	-	-	-	-	-
Liquid Stream Treatment					
Power for Treatment (electricity)	72	g CO ₂ e/kw-hr	0.000072	tonne/kw-hr	BC Hydro, 2004 report
Treatment Chemicals					
<i>Alum</i>	0.539	kgCO ₂ -e/kg dry	0.000539	tonne/kg Alum	de Haas et al 2008
<i>Chlorine</i>	1.124	kgCO ₂ -e/kg dry	0.001124	tonne/kgCL	de Haas et al 2008
Direct Emissions (CH ₄ & N ₂ O)					
Methane during Treatment and Outflow	0	0	0	0	Willis, personal communication
Nitrous Oxide (outfall)	0.0005-0.25	kg N ₂ O-N/kg N	0.000148	tonneCO ₂ /kg N	IPCC, 2006
Solids Treatment & Disposal					
Power for Treatment (Biosolids treatment & Scrubbing)	72	g CO ₂ e/kw-hr	0.000072	tonne/kw-hr	BC Hydro, 2004 report
Treatment Chemicals (Polymer)	1.182	kg CO ₂ -e/kg dry	0.001182	tonne/kgPolymer	de Haas et al 2008
Direct Emissions (CH ₄ & N ₂ O)					
<i>Methane from scrubbing</i>	1	% of volume	23	units CO ₂ /unit methane	
<i>Methane from land application</i>	negligible				Brown, personal communication
<i>Nitrous Oxide from Combustion of Solids</i>	1520-6400	g-N ₂ O/ton DT	1.063360109	tonneCO ₂ /tDT	Suzuki et al 2003
Power for Soil Amendment Blending	4.17	L fuel/DT solids	0.011	tonnesCO ₂ /drytonne	Tagro, personal communication
Transportation (Diesel Fuel)	2637	g CO ₂ /L	0.002637	tonne/L	Brown, Biocycle 2004; EIA; GRP

Components	Literature Value	Units	Conversion to tonne CO ₂	Units	Source
Resources from Wastewater					
Saleable Heat for District Heating Offset	50.3	kg/GJ	.0503	tonne CO ₂ /GJ (based on natural gas)	EIA
Biosolids & Struvite Fertilizer Offset					
<i>Avoidance N fertilizer</i>	3.96	kg CO ₂ /kg N	0.00396	tonne/kg N	ROU, 2006
<i>Avoidance P fertilizer</i>	1.76	kg CO ₂ /kg P	0.00176	tonne/ kg P	ROU, 2006
Carbon Sequestration (Soil Amendment & Willow Coppice)	0.3	tonnes CO ₂ /dry tonne applied	0.3	tonnes CO ₂ /dry tonne applied	Brown, personal communication
Dried Product Fuel Offset (Cement kiln, etc.)	94.14	kg CO ₂ /GJ	0.09414	tonne/GJ	Abu-Orf etal 2008; EIA
Willow Coppice Offsets (burning wood)	1000.00	g CO ₂ /kg wood burned	1	tonne CO ₂ e/tonne	Climate Registry: GRP 2008
Biocell Gas Capture	0.067	Mg CH ₄ /Mg solids	0.7705	tonne CO ₂ e /tonne solids	Brown, personal communication

Assumptions:

- The heat recovery system used for warming the digester and the dryer offsets natural gas use.
- The saleable district heat offsets the natural gas required to heat the district
- Building heat, digester heat and drying are typically offset by digester gas and were therefore, not considered an offset of fossil fuels
- No methane is emitted from the digester.
- No methane is emitted from the conveyance system.
- One percent of methane is lost as fugitive emissions from the scrubber.
- The 2004 average annual emissions factor for electricity from BC Hydro was used. A heating season emissions factor was not included due to the fact that the actual usage for 2005 was much lower than the BC hydro projection for that year. The 2008 projection is assumed to also be too high.
- The offsets due to reclaimed water are expected to be minimal and were not included in this analysis due to a lack of available data at this time.
- No environmental life cycle costs were assumed for the soil product mixing materials of wood and sand.

- The biosolids results in this analysis are based on preliminary design assumptions and are subject to refinement after determination of actual solids characteristics and analysis of design options under Canadian regulations.
- In determination of the fertilizer offsets, total nitrogen was used instead of available nitrogen as a simplification.
- Emissions associated with treatment chemicals used in liquid stream treatment were not included due to lack of data available at this time on chemical quantity usage.
- The biocell will capture approximately 50% of the emissions that would be released by landfill of biosolids
- Offsets associated with co-digestion of organic waste beyond increased gas production were not included in the analysis at this time due to a lack of available data.

7.2 Carbon Footprint Impact

The estimated annual carbon footprint in tonnes of CO₂ associated with each treatment option in the design year of 2030 is summarized in **Table 7.2**. This analysis is based on initial design assumptions for each alternative. Further refinement of this analysis will be conducted in the future as the alternatives analysis and design process proceeds.

The results of this analysis indicate that the overall net carbon footprint of all three alternatives is negative due to the extensive utilization of wastewater resources such as biosolids, biogas, and heat recovery in the system design, which offsets the use of fossil fuels. A negative carbon footprint indicates a beneficial environmental impact related to GHG emissions. For recovered heat it has been assumed that 5% of the available heat is used in 2016 increasing to 25% in 2030 and 65% for 2065. For option 1B and 1C, the available heat used from the West Shore was reduced from these numbers to account for limits in the market near the West Shore site.

The carbon footprint associated with each of the alternatives is estimated to be very similar based on the available data and assumptions from the preliminary design. Options 1B and 1C are estimated to have a lower carbon footprint than Option 1A for construction-related emissions. For operation-related emissions, all three alternatives are estimated to have a similar negative carbon footprint. Option 1A is estimated to have the lowest overall carbon footprint of the three alternatives by a slight margin due to higher offsets for heat recovery.

Table 7.2
Summary of GHG emissions associated with alternatives in 2030 design year (Tonne CO₂e/yr)

Components	Option 1A	Option 1B	Option 1C
Construction (Emissions associated with concrete and steel production and site excavation) One time emission during construction period. Therefore, not included in 2030 design year total	15,516	9,935	9,935
Conveyance			
Direct GHG Emissions (Assumed zero for this analysis)	0	0	0
Power for Conveyance (pumping)	183	514	832
Liquid Stream Treatment			
Power for Treatment	3,071	2,868	3,135
Heat Pump Power for District Heating	3,182	2,740	2,740
Direct Emissions (CH ₄ & N ₂ O)	12	12	12
Solids Treatment			
Power for Treatment (Biosolids treatment and gas scrubbing and heat extraction for digester heating and drying)	1,213	858	858
Treatment Chemicals	195	251	251
Direct Emissions (CH ₄ & N ₂ O)	49	49	49
Power for Soil Amendment Blending	12	12	12
Resources from Wastewater			
Gas Offsets (Digester & Dryer)	0	0	0
Saleable Heat For District Heating	-16,307	-13,853	-13,853
Biosolids Fertilizer Offset	-189	-189	-189
Carbon Sequestration (Soil Amendment and Willow Coppice)	-498	-498	-498
Dried Product Fuel Offset (Use in cement kiln or other biofuel use)	-1,742	-1,742	-1,742
Willow Coppice Offsets (Use of wood as biofuel)	-736	-736	-736
Gas Sale Carbon Offset	-6,199	-6,199	-6,199
Struvite offsets	-250	-250	-250
Biocell Landfill Gas Capture	-851	-851	-851
Total Annual Emissions Design Year 2030 (Excluding construction-related emissions)	-18,855	-17,244	-16,430

7.3 Recovery of Saleable Products & Greenhouse Gas Offsets

The potential saleable products included in the alternative designs include: methane biogas, recovered heat, struvite, a biosolids topsoil product and dried fuel product, wood chips for energy offsets and reclaimed water. For a discussion of the production and benefit of these products refer to Section 6 of this report. Each of these products is derived from the renewable source of wastewater residuals. A subsequent benefit is that renewable sources of energy and nutrients can provide an offset of equivalent GHG emissions associated with nonrenewable sources of energy and nutrients. A brief overview of the GHG offsets incorporated in this analysis related to these products is provided in this section.

Table 7.1 summarizes the emissions factors associated with the offsets described in this section. The emissions factors associated with the offsets are based on professional judgment of the best available data and research at this time. As additional data and research becomes available, emissions factors associated with offsets may be modified in the future.

For the purposes of this carbon footprint analysis, GHG offsets refer to the amount of anthropogenic greenhouse gases avoided by utilizing alternative renewable resources. For example, digester gas captured during anaerobic digestion of solids can be scrubbed and sold as a biogas product. The digester gas is used in lieu of natural gas or other fossil fuels. Because the burning of natural gas releases anthropogenic GHG, the amount of natural gas not burned due to the capture and use of digester gas is considered an offset for the purposes of this analysis. When food sources such as brown grease are added to the digester to boost gas production, the offsets associated with use of the digester gas are increased.

Heat recovery at the wastewater treatment facilities involves recovery of heat from the digester effluent with heat pumps, and the use of recovered heat to provide process heating at the facility, building heating, and regional heating through a pumped heat loop. Although heat recovery requires the input of electricity, the electrical equivalent of the heat that is recovered is greater than the input, resulting in a net reduction in electricity or fuel usage for heating purposes. In the alternatives analysis, the heat pumps are estimated to provide a coefficient of performance of about 3.5. This means that for every 1kW of electricity sent to the heat pumps, 3.5kW of heat will be provided to the heat loop. The net reduction in fuel usage required for heating with the use of heat pumps is taken into account as an offset for this analysis.

Struvite, biosolids topsoil products and reclaimed water are other resources that provide sources of GHG offsets. These products can be land applied in place of chemical fertilizers, offsetting the industrial production of nitrogen and phosphorous. Biosolids also provide an additional benefit by sequestering carbon in “disturbed” soils by adding organic matter, which increases the soil carbon and the soil storage capacity.

A dried biosolids fuel product as well as wood chips (derived from trees grown where biosolids are applied) can be used in lieu of burning of coal as a heat/energy source in cement manufacturing, pulp mills or waste to energy facilities. Although the nutrient value of the

biosolids is lost during this practice, the use of fossil fuels in these processes is reduced which results in a carbon offset.

7.4 Solar Energy

Most solar energy use in British Columbia has been limited to installations for hot water heating. Even in these installations the payback for user of this energy does not recover the capital investment. For the CAWTP where significant amounts of energy are required for digester and building heating, it is not anticipated the use of solar energy would be feasible.

Section 8 Basis of Opinion of Probable Capital Costs

8.1 Cost Basis

To enable completion of triple bottom line assessments and to obtain an initial indication of capital costs for each of options 1A, 1B and 1C cost estimates were prepared for each option. The basis of the estimates follow a similar format as completed by the previous consultants with respect to direct and indirect costs to provide a basis of comparison of costs.

The cost estimates are comprised of the following:

Direct Costs

- Capital construction costs.
- Design contingency at 10% of construction costs.
- Construction contingency costs at 15% of construction costs.

Indirect Costs

- Engineering at 15% of direct costs.
- Administration at 3% of direct costs.
- Miscellaneous at 2% of direct costs.

Financing Costs

- Interim Financing at 4% of direct and indirect costs.
- Inflation to Midpoint of construction 2% per annum to 2014.

It is noted that capital costs could vary depending on market conditions at time of tender, the overall procurement strategy and the risk profile of a particular project.

8.2 Capital Costs

To arrive at preliminary capital costs conceptual level layouts were prepared for facilities and sited on the potential sites under consideration for Options 1A, 1B and 1C. Representative technologies were selected for the purposes of preparing cost estimates at each site. Drawings

for each option are appended to this report. The capital costs (rounded to nearest \$1 million) for each option are summarized in **Table 8.1**.

**Table 8.1
 Capital Costs**

Capital Costs	Option 1A	Option 1B	Option 1C
Total Capital Costs	\$965,000,000	\$875,000,000	\$885,000,000

Capital costs are subject to some modification depending on the degree of mitigation and further more detailed engineering works. Option 1A has the highest capital cost. This can be attributed to the fact that there are two biosolids facilities and construction conditions at McLoughlin are more difficult than the West Shore options 1B and 1C.

8.3 Operations and Maintenance Costs

Table 8.2 provides operations and maintenance costs for each option.

**Table 8.2
 Annual O&M Costs**

	Option 1A	Option 1B	Option 1C
Annual O&M Costs	19.8 million	19.6 million	19.8 million

Annual operation and maintenance costs are considered similar for all options and does not consider offsets from potential revenue from resource recovery.

8.4 Life Cycle Costs

Life cycle costs were prepared using a net present value approach and a 6% discount rate. The life cycle costs include capital and operating costs and repair and replacement costs over a 25 year period. It is assumed that operation of the plants would commence in 2016 therefore 2009 capital costs were discounted to 2016 dollars for relative comparison of options. Life cycle costs for the various options are presented in **Table 8.3**.

**Table 8.3
 Life Cycle Costs**

Costs	Option 1A	Option 1B	Option 1C
Life Cycle Costs	\$806,000,000	\$741,000,000	\$750,000,000

Option 1A has a higher life cycle cost because there are two wet weather treatment plants at Clover and McLoughlin and two biosolids facilities which must be operated.

Section 9 Triple Bottom Line Analysis Framework

CRD has adopted the Triple Bottom Line (TBL) evaluation approach to provide the basis for selection of the preferred alternative. By understanding the economic, environmental and social implications of the alternatives that are reflective of the community values, the most long term sustainable decisions can be made.

Economic impacts are the direct costs to a public agency that are traditionally associated with an economic analysis. Capital costs and wastewater resource revenues are considered as well as ongoing operations and maintenance costs. Environmental costs are the environmental implications of an agency's actions that customers place value on. Examples include potential loss of terrestrial resources and potential risks from sewage spills. A sewage spill may cost a utility not only the fines incurred from regulators, but also the environmental "cost" of pollution. Social costs, like environmental costs, are indirect costs to the community. An example of this is the inconvenience of traffic delays caused by construction. The utility does not directly pay for the "cost" of traffic but its customers place a value on avoiding unnecessary traffic delays.

This chapter outlines the triple bottom line analysis that was used to evaluate the three options for the CRD's Core Area Liquid Waste Management. The basis for placing value on both direct and indirect costs is detailed and a summary of the evaluation results concludes the chapter.

9.1 Triple Bottom Line Methodology

The TBL analysis built upon the recommendations from the Peer Review Committee. The peer review committee's list of triple bottom line impacts had been organized into the TBL three categories as well as an 'Other'. Those impacts listed under "Other" were moved into either the economic, environmental, or social category heading, some impacts were modified to better measure the intended impact, and some impacts were added. A complete listing of impacts included in the model sorted by the three categories is provided in **Table 9.1**.

Table 9.1
Impacts Evaluated for Triple Bottom Line Analysis

Criteria Group	No.	Criteria Categories	Measure Description
Economic	EC-01	Capital Costs	construction cost and markup for soft costs adjusted to midpoint of construction
	EC-02	Capital Costs Eligible for Grants	Not available at this time
	EC-03	Tax Revenue Implications	cost of private property lost and lost revenue from reduced property values
	EC-04	Present Worth of O&M costs	O&M costs
	EC-05	Flexibility for Future Treatment Process Optimization	cost of additional tankage needed for process optimization
	EC-06	Expandability for Population Increases	additional space needed versus available to meet 2065 loading
	EC-07	Flexibility to Accommodate Future Regulations	additional space needed versus available to meet potential regulations
Environmental	EN-01	Carbon Footprint	tons of eCO2 created
	EN-02	Heat Recovery Potential	Heat energy replacing natural gas
	EN-03	Water Reuse Potential	megaliters per day available
	EN-04	Biomethane Resource Recovery	Recovery of biomethane resources
	EN-05	Power (energy) usage	kilowatt hours per year consumed
	EN-06	Transmission Reliability	risk cost of pump station failure
	EN-07	Site Remediation	risk cost of site remediation
	EN-08	Pollution Discharge	tons of pollutants discharged
	EN-09	Non-renewable Resource Use	Gallons of diesel consumed per year
	EN-10	Non-renewable Resource Generated	Struvite and biosolids production
	EN-11	Flexibility for Future Resource Recovery	Additional space needed to add 100% additional resource recovery
	EN-12	Terrestrial and Inter-tidal Effect	Habitat areas potentially disturbed
Social	SO-01	Impact of Property Values	Perception of lost value to current property owners
	SO-02	Operations Traffic in Sensitive Areas	Cost of traffic inconvenience during operations
	SO-03	Operations Noise in Sensitive Areas	Cost of noise inconvenience
	SO-04	Odour Potential	Cost of odour issues
	SO-05	Visual Impacts	Cost of lost open water or territorial view
	SO-06	Construction Disruption	Cost of traffic inconvenience due to construction

Criteria Group	No.	Criteria Categories	Measure Description
	SO-07	Public and Stakeholder Acceptability	Lost time due to public disapproval
	SO-08	Impacts on Future Development	Loss of value of developable land adjacent to plant
	SO-09	Loss of Beneficial Site Uses	Loss of park land due to plant
	SO-10	Compatibility with Designated Land Use	Delay due to zoning changes
	SO-11	Cultural Resource Impacts	Risk cost of a cultural site find

With the impacts identified, the next step in the model was to collect the data required to accurately measure each impact. For some impacts, the data needed were obvious (e.g., capital costs were measured using the estimated construction cost) but for others, a surrogate measure was used to capture the lion's share of the impact (e.g. visual impacts was measured through the loss of value due to a blocked open water or territorial view). The assumptions and values associated with each impact are included in the following section.

With the data and assumptions collected and documented, the model calculated a value for each impact, for each option. The results are provided on a summary table and can be presented graphically as well. **Figure 9.1** demonstrates the TBL methodology from data collection to graphical presentation.

Triple Bottom Line Methodology

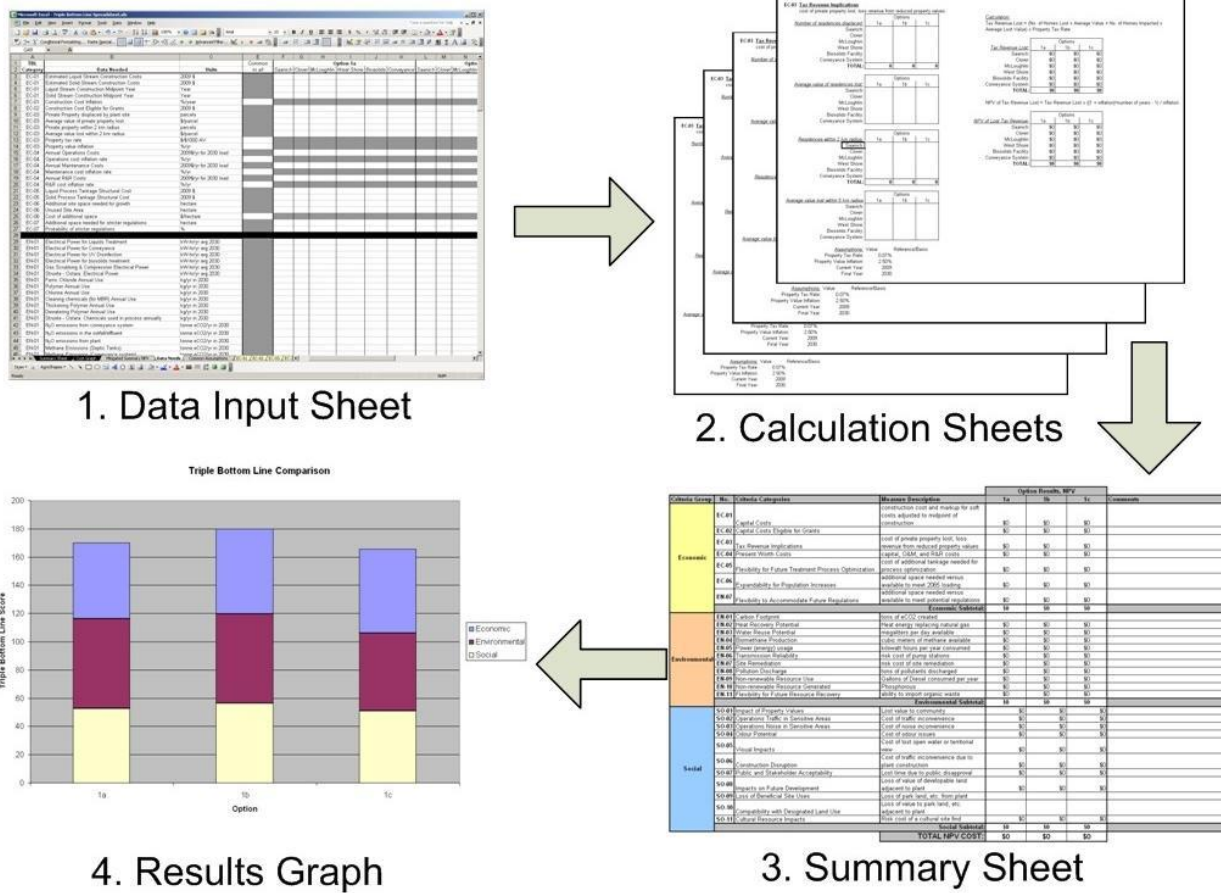

Figure 9.1: TBL Methodology

9.2 Placing Value on Factors

The foundation of the TBL model is the assumptions and data provided for the calculations. The quality of the data input dictates the quality of the output and as such, it is important that the correct data is collected. In addition, a monetary value has been assigned to impacts where appropriate but a majority of the social costs do not lend themselves well to monetization without making some assumption on the value the agency's customers place on the impact. As an example, even if the number of drivers impacted and the delay per driver could be calculated for construction disruption, a monetary value would ultimately depend on the value drivers place on their time. Without feedback from CRD's customers, assuming a value at this time was considered inappropriate and a qualitative 1 to 5 scale was used for this and other impacts.

To insure that the TBL model is accurately measuring the value associated with each option, the data and assumptions for each impact are detailed below. All ultimate values are expressed as

net present worth values (NPV), calculated over a 50 year period from 2015 through 2065. The results and assumptions built into the value of each impact must be given proper scrutiny and constructive feedback will result in more accurate model results.

9.2.1 Economic Impacts

EC-01 Capital Costs

Capital costs measure the construction cost and soft costs for each option escalated to the midpoint of construction. Data input included the estimated construction cost and a 2014 midpoint of construction. Assumptions included an inflation rate of 3%. The scoring for capital costs was scaled based on the NPV of costs for all three options with an NPV of \$800 million worth three points, higher NPVs worth fewer points, and lower NPVs worth more.

EC-02 Capital Costs Eligible for Grants

This impact was intended to measure the value of grants to offset construction costs, but at this time, insufficient information is available to adequately account for this impact.

EC-03 Tax Revenue Implications

The construction of a treatment facility or pump station will remove some property from the community tax base and will result in lost property tax revenues. The NPV of property tax revenues lost was calculated by multiplying the land purchase price for each site area by the surrounding mill rate. A qualitative 1 to 5 score was scaled based on the cost of lost tax revenue as shown below.

EC-03 Scoring:	
1	More than \$35 million
2	\$25 to \$35 million
3	\$15 to \$25 million
4	\$5 to \$15 million
5	Less than \$5 million

EC-04 Present Worth Costs

Present worth included annual expenditures for operations and maintenance (O&M) and for replacement and refurbishment (R&R) projects. Data input included annual O&M and R&R costs. Assumptions included a 3% rate of inflation for each annual cost. The scoring was scaled based on the annual costs with an annual cost of \$18 million worth 3 points, a higher annual cost worth fewer points, and lower annual costs worth more.

EC-05 Flexibility for Future Treatment Process Optimization

This impact was intended to measure the flexibility for each option to allow for new process optimizations not yet developed. To measure this, the portion of construction costs spent on structural tankage was compared for each option as well as a “Process Optimization Factor” based on the process type used. MBR treatment was given a 0.9 factor, BAF was given a 0.8 factor, and CAS was given a 0.5 factor where a smaller factor indicates more flexibility for optimization. The cost for tankage at each site was multiplied by the process optimization factor and each option was scored using the following scale.

EC-05 Scoring:	
1	More than \$50 million
2	\$40 to \$50 million
3	\$30 to \$40 million
4	\$20 to \$30 million
5	Less than \$20 million

EC-06 Expandability for Population Increases

Population increases will result in additional plant site needed to expand plant capacity. The data input for this impact was the planned used site area and an estimate of the percentage of expansion available without additional site area based on optimizing the current process. MBR treatment was assumed to only be able to expand by 10%, BAF by 10%, and CAS by 40%. A \$2 million per hectare cost for additional property was assumed and a cost of expansion was calculated by assuming a 100% increase in capacity would be needed. The cost of expansion for each option was scored as follows.

EC-06 Scoring:	
1	More than \$17 million
2	\$14 to \$17 million
3	\$11 to \$14 million
4	\$8 to \$11 million
5	Less than \$8 million

EC-07 Flexibility to Accommodate Future Regulations

Like treatment process optimization, stricter regulations will most likely require more structural tankage. Construction costs on process tankage and the “Process Optimization Factor” described in EC-06 were the data input for this impact. Assumptions included a 5% to 25% probability of stricter regulations by 2065 based on process type. A NPV was calculated for each option and scored based on the following scale.

EC-07 Scoring:	
1	More than \$16 million
2	\$12 to \$16 million
3	\$8 to \$12 million
4	\$4 to \$8 million
5	Less than \$4 million

9.2.2 Environmental Impacts

EN-01 Carbon Footprint

The details of the carbon footprint calculation have been presented in section 7. Scoring was based on the NPV of offsets for equivalent tonnes of carbon dioxide emitted (assuming \$25 per tonne) using the following scale.

EN-01 Scoring:	
1	More than \$20 million
2	\$5 million to \$20 million
3	-\$5 million to \$5 million
4	-\$5 million to -\$20 million
5	Less than -\$20 million

EN-02 Heat Recovery Potential

This impact measures the potential amount of heat energy recovered at each site that would replace natural gas use. Data inputs include potential off-site and on-site energy recovery, \$10/GJ cost of natural gas, and a 0.38% growth rate. A 5% rate of inflation for natural gas costs was assumed. The NPV for each option was calculated and compared using the following scale.

EN-02 Scoring:	
1	Less than \$200 million
2	\$200 to \$250 million
3	\$250 to \$300 million
4	\$300 to \$350 million
5	More than \$350 million

EN-03 Water Reuse Potential

Water reuse potential was a measure of drinking water that could be replaced by reclaimed water. The potential volume of reclaimed water produced, a \$0.72/cubic meter cost of water, and a 0.38% growth rate were the data inputs. A 3% inflation in water costs was assumed. The NPV for each option was calculated and compared using the following scale.

EN-03 Scoring:	
1	Less than \$10 million
2	\$10 to \$20 million
3	\$20 to \$30 million
4	\$30 to \$40 million
5	More than \$40 million

EN-04 Biomethane Production

Biomethane production was assumed to offset use of natural gas. In addition, tipping fees from codigestion substrate were included as part of this impact. The data inputs for this impact were the volume of biomethane recovered, the annual volume of tipping, a \$10/GJ value of natural gas, a \$0.035 per liter tipping fee, and a 0.38% growth rate. A 5% inflation rate for natural gas costs was assumed. The NPV for each option was calculated and compared using the following scale.

EN-04 Scoring:	
1	Less than \$50 million
2	\$50 to \$100 million
3	\$100 to \$150 million
4	\$150 to \$200 million
5	More than \$200 million

EN-05 Power (energy) Use

This impact compared the electrical energy usage for each option. Data input included annual power consumption, a \$0.08/kW-hr cost of power, and a 0.38% growth rate. Assumptions included a 3% rate of inflation for power costs. The NPV for electrical costs was calculated for each option and then scaled as follows.

EN-05 Scoring:	
1	More than \$375 million
2	\$325 to \$375 million
3	\$275 to \$325 million
4	\$225 to \$275 million
5	Less than \$225 million

EN-06 Transmission Reliability

This impact measure the relative risk carried for each option in terms of a conveyance failure. Data inputted were the number of stations, the volume pumped by each station, and the length of piping. Each option was compared by multiplying the volume pumped by the distance pumped. A \$300 risk cost per ML-km/day was assumed and a NPV was calculated. The following 1 to 5 score scaled was used.

EN-06 Scoring:	
1	More than \$15 million
2	\$10 to \$15 million
3	\$5 to \$10 million
4	\$2 to \$5 million
5	Less than \$2 million

EN-07 Site Remediation

Site remediation could significantly increase construction costs. To measure this, the direct cost of remediation, the potential delay due to remediation, and the estimated construction cost were used as data inputs. Assumptions included a 3% inflation rate, a \$300,000 remediation cost per hectare, and a probability of remediation at each site. The risk cost of remediation activities was calculated for each option and compared using the following scale.

EN-07 Scoring:	
1	More than \$15 million
2	\$11 to \$15 million
3	\$7 to \$11 million
4	\$3 to \$7 million
5	Less than \$3 million

EN-08 Pollution Discharge

Pollution discharged measured the mass volume of total suspended solids (TSS) in the effluent for each option. TSS concentration and average dry weather design flow were included as data input. A \$1/kg cost for solids discharged was assumed and a NPV was calculated. The following 1 to 5 scale was used to compare the three options.

EN-08 Scoring:	
1	More than \$40 million
2	\$30 to \$40 million
3	\$20 to \$30 million
4	\$10 to \$20 million
5	Less than \$10 million

EN-09 Non-Renewable Resource Use

This impact measured diesel fuel consumption during construction and operations. Diesel consumption during construction was assumed to be 2% of construction costs and diesel consumption during operations was assumed to be 2% of O&M costs. Therefore, data inputted were construction costs and O&M costs. A 3% inflation rate was assumed and a NPV was calculated for each option. The options were scored using the scale below.

EN-09 Scoring:	
1	More than \$50 million
2	\$40 to \$50 million
3	\$30 to \$40 million
4	\$20 to \$30 million
5	Less than \$20 million

EN-10 Non-Renewable Resource Generated

Non-renewable resource generated measured the struvite and biosolids production for each option. Data input included the volume of struvite and biosolids produced, and a split of biosolids use of 10% coppice, 20% soil amendment, 50% cement kiln fuel, and 20% biocell. The value of struvite was assumed to be \$1,200/tonne. Biosolids used for cement kiln use was assumed to be worth \$60/tonne, biosolids used for soil amendment were assumed to be worth \$114/tonne, and biosolids sent to willow coppice were assumed to be worth \$123/tonne. Biosolids used for biocell were assumed to generate no net revenue. The NPV based on annual revenue for each option was calculated and scores were given based on the following scale.

EN-10 Scoring:	
1	Less than \$5 million
2	\$5 to \$15 million
3	\$15 to \$25 million
4	\$25 to \$35 million
5	More than \$35 million

EN-11 Flexibility for Future Resource Recovery

Future resource recovery was measured by the available space for additional solids treatment process structures. Data input included planned site area used for solids treatment. Assumed was a 25% increase in used hectares for future solids treatment and a \$2 million per hectare cost for additional site space. The cost for expansion was calculated for each option and scored using the following scale.

EN-11 Scoring:	
1	More than \$2.5 million
2	\$2 to \$2.5 million
3	\$1.5 to \$2 million
4	\$1 to \$1.5 million
5	Less than \$1 million

EN-12 Terrestrial and Inter-tidal Habitat Impacts

This measure was intended to measure the impact siting would have on existing terrestrial and inter-tidal habitats. Sensitive areas were identified using the CRD's Harbours Atlas and a relative 1 to 5 score was given based on the potential mitigation cost for each habitat impacted (assumed to be \$1 million per site impacted). The following scale was used.

EN-12 Scoring:	
1	More than \$5 million
2	\$4 to \$5 million
3	\$3 to \$4 million
4	\$2 to \$3 million
5	Less than \$2 million

9.2.3 Social Impacts

SO-01 Impact on Property Values

Lost values for existing private properties are not expected but a perception of lost value constitutes a social cost. This impact was measured by assuming that the parcels within a 500 m radius within each site would be perceived to lose 1% of an assumed average value of \$500,000. The societal impact was calculated by multiplying the number of parcels that were impacted by \$5,000 and scored as shown below.

SO-01 Scoring:	
1	More than \$1.25 million
2	\$1 million to \$1.25 million
3	\$750,000 to \$1 million
4	\$500,000 to \$750,000
5	Less than \$500,000

SO-02 Operations Traffic in Sensitive Areas

The intent of this measure was to capture the impact of operations traffic near residential areas. This impact was measured using the traffic counts from CRDs 2005 evaluation near each site area and the estimated O&M costs at each site. The number of operations vehicles was estimated as 1 per \$500 of O&M cost, the cost of a commuter impacted by an operations trip was estimated as \$0.50 and the probability of this cost being incurred was assumed to be 1%. This, a cost for operations traffic was calculated for each site and scaled as follows.

SO-02 Scoring:	
1	More than \$18 million
2	\$13 to \$18 million
3	\$8 to \$13 million
4	\$3 to \$8 million
5	Less than \$3 million

SO-03 Operations Noise in Sensitive Areas

Noise due to operations is a societal cost on nearby residents and businesses. To capture this cost, it was assumed that only parcels within 500 meters of each site could be potentially impacted by noise. A 1% property value was used as a surrogate to capture the scale of the cost of noise. A \$500,000 average home value was assumed and each option was given a qualitative 1 to 5 score as shown below.

SO-03 Scoring:	
1	More than \$1.25 million
2	\$1 million to \$1.25 million
3	\$750,000 to \$1 million
4	\$500,000 to \$750,000
5	Less than \$500,000

SO-04 Odour Potential

Odour can be a nuisance to nearby residents and businesses. To capture this impact, the residences and businesses potentially impacted by odour were assumed to be those within 500 meters of each site. As with noise impacts, odour costs were measured using home values as a surrogate. For each site, the number of homes and residential equivalents within 500 m was estimated, a \$500,000 average value was assumed, and a 25% property value was assumed for odour issues. Thus, a cost for odour issues was calculated and a qualitative 1 to 5 score was given as shown below.

SO-04 Scoring:	
1	More than \$60 million
2	\$55 million to \$60 million
3	\$40 to \$55 million
4	\$25 to \$40 million
5	Less than \$25 million

SO-05 Visual Impacts

The loss of an open water or territorial view or the addition of a treatment facility to an otherwise open view is a loss for the community. This impact was measured by estimating the number of residences within 500 m of each site and assuming a view would be worth 2% of a \$500,000 average home value. The cost of each option was calculated and compared using the following scale.

SO-05 Scoring:	
1	More than \$2.5 million
2	\$2 to \$2.5 million
3	\$1.5 to \$2 million
4	\$1 to \$1.5 million
5	Less than \$1 million

SO-06 Construction Disruption

Traffic during construction can be particularly noisome to neighboring residents and businesses. To measure this disruption, the volume of traffic potentially impacted by plant construction was estimated by using traffic counts at nearby intersections for each site. These traffic counts came from CRD's 2005 evaluations. The number of construction trips was calculated by estimating one construction trip per day for every \$2,500 of construction budget. The traffic count was multiplied by the daily construction traffic at each site and a plant construction disruption cost was calculated assuming a \$1 cost per trip delayed, a 1% probability of delay due to construction and a 3 year construction period.

For conveyance construction, the number of kilometers of pipe was used to estimate the number of trips delayed. The conveyance construction cost was calculated by multiplying the length of pipe by the traffic count as well as assuming a \$2 cost per trip delayed, a 50% probability of delay, and an 8 month construction schedule. The schedule was modified by including a "pipeline disruption factor" that increased the construction time for areas with a high level of interference with other existing utilities. The plant and conveyance construction disruption costs were added together and a qualitative 1 to 5 score was then given as shown below.

SO-06 Scoring:	
1	More than \$40 million
2	\$30 to \$40 million
3	\$20 to \$30 million
4	\$10 to \$20 million
5	Less than \$10 million

SO-07 Public and Stakeholder Acceptability

Delays caused by public disapproval could be costly during the construction period. A delay was assumed for each site for each option and the construction cost was delayed by that number with a 3% inflation rate. A 25% probability of delay was assumed at each site and thus the risk of delay costs were compared for each option using the following scale.

SO-07 Scoring:	
1	More than \$10 million
2	\$7 to \$10 million
3	\$4 to \$7 million
4	\$1 to \$4 million
5	Less than \$1 million

SO-08 Impacts on Future Development

Future development in undeveloped areas near treatment sites may be hindered due to the presence of a treatment facility. To capture this cost, it was assumed that only a proportion of the number of undeveloped hectares within 2 kilometers would be impacted. This proportion was estimated as follows.

Percentage of Undeveloped Land Potentially Impacted:

	Options		
	1a	1b	1c
East Saanich:	10%	10%	10%
Clover Point:	5%	5%	2%
McLoughlin Point:	10%	5%	2%
West Shore:	10%	20%	20%
Biosolids Facility:	20%	-	-

Furthermore, a \$200,000 cost per hectare was assumed to be lost for future development. The value lost at each site was calculated and compared using the following scale.

SO-08 Scoring:	
1	More than \$25 million
2	\$20 to \$25 million
3	\$15 to \$20 million
4	\$10 to \$15 million
5	Less than \$10 million

SO-09 Loss of Beneficial Site Use

The addition of a treatment facility may preclude the use of the site as an open space or park land. To measure this impact, the number hectares of potential park or open space lost due to plant siting was estimated and an assumption of a \$1,000,000 per hectare incremental value for using the site as a park instead of a treatment facility was assumed. The scale used to compare options is presented below.

SO-09 Scoring:	
1	More than \$16 million
2	\$13 to \$16 million
3	\$10 to \$13 million
4	\$7 to \$10 million
5	Less than \$7 million

SO-10 Compatibility with Designated Land Use

Converting site zoning to allow for a treatment plant or pumping station a site can delay the overall construction schedule as various municipal offices are involved. This delay was assumed to be 6 months, independent of the zoning of the current site. As such, each option’s construction cost was escalated by 6 months at an assumed 3% inflation rate. The cost of this delay was then compared for each option using the scale below.

SO-10 Scoring:	
1	More than \$20 million
2	\$15 to \$20 million
3	\$10 to \$15 million
4	\$5 to \$10 million
5	Less than \$5 million

SO-11 Cultural Resource Impacts

A cultural resource find would cause additional cost and delay to site construction. The probability of a cultural find for each site and the resulting delay were estimated along with the estimated construction cost. An assumed 3% inflation rate was used to quantify the delay cost of a cultural find. By multiplying the delay cost by the probability of a find, the risk cost of a cultural find was calculated for each option and compared using the following scale.

SO-11 Scoring:	
1	More than \$2 million
2	\$1.5 to \$2 million
3	\$1 to \$1.5 million
4	\$500,000 to \$1 million
5	Less than \$500,000

9.3 Alternative Evaluation

The numerical scoring of each category in the TBL evaluation for options 1A, 1B and 1C are presented in Table 9.2, and the same information is illustrated graphically in Figure 9.2. The maximum score for each category is 5 and the minimum score is a 1. Scoring between the minimum and maximum value was based on whole numbers. A higher score reflects a more favorable outcome of the option when considering the specific category. To account for differing number of categories within the Economic, Environmental and Social criterion, the categories have been weighted so that the maximum possible score is limited to 100. Within the Economic criteria the individual categories have been weighted in proportion to their respective calculated NPV. The results of this is to weight capital project cost and the 50-year stream of annual operations, maintenance and refurbishment and replacement costs at 8 times the value of the remaining four categories. For the Environmental and Social criteria the individual categories were not differentially weighted as the underlying financial analysis that formed the basis for the individual numeric scoring included more subjective inputs as compared to the line items in the Economic criteria group.

The results of scoring the Economic criteria for options 1A, 1B and 1C are 54 points, 60 points and 61 points respectively. Options 1B and 1C are the highest ranked due mainly to both their lower capital costs and annual operational costs.

The results of scoring the Environmental criteria for Options 1A, 1B and 1C are 63 points, 63 points and 55 points respectively. The main reason for Options 1A scoring higher is in the categories of EN-02 Heat Recovery and EN-06 Transmission Reliability. Option 1B scores higher in EN-07 Site Remediation. The reason for the overall scoring being higher than the Economic and Social criteria is the high degree of resource recovery and mitigation for Green House Gases of all three options.

The results of scoring the Social criteria for Options 1A, 1B and 1C are 53 points, 56 points and 51 points respectively. A review of the scoring indicated that 1A scored higher in SO-08 Impacts on Future Development because of the negative impacts of a larger wastewater treatment facility located on the West Shore for Options 1B and 1C. Options 1B and Option 1C scored higher in the categories SO-02 Operations Traffic in Sensitive Areas; category SO-04 Odour Potential due to the constrained biosolids site for Option 1A; and category SO-06 Construction Disruption due to the more congested urban environment. The overall points allocation for the Social criteria were lower than the Environmental scoring reflecting the fact that some of the social impacts can not be totally mitigated.

When the three criteria groups are summed the resulting TBL scores for Options 1A, 1B and 1C are 170 points, 180 points and 166 points respectively. The TBL analysis ranks option 1B as the preferred option.

**Table 9.2
 Summary Table of TBL Analysis Results**

Criteria Group	No.	Criteria Categories	Measure Description	Weight	Option Results			Comments
					1a	1b	1c	
Economic	EC-01	Capital Costs	construction cost and markup for soft costs adjusted to midpoint of construction	8	2.5	2.7	2.7	Costs included for resource recovery systems
	EC-02	Capital Costs Eligible for Grants	Not available at this time	-	-	-	-	
	EC-03	Tax Revenue Implications	cost of private property lost and lost revenue from reduced property values	1	3	4	4	
	EC-04	Present Worth of O&M costs	O&M costs	8	2.7	2.8	2.7	Costs included for resource recovery systems
	EC-05	Flexibility for Future Treatment Process Optimization	cost of additional tankage needed for process optimization	1	3	4	4	
	EC-06	Expandability for Population Increases	additional space needed versus available to meet 2065 loading	1	3	4	4	
	EC-07	Flexibility to Accommodate Future Regulations	additional space needed versus available to meet potential regulations	1	3	4	4	
Economic Subtotal (100 pts max)¹:					54	60	60	
Environmental	EN-01	Carbon Footprint	tons of eCO2 created	1.67	4	4	4	
	EN-02	Heat Recovery Potential	Heat energy replacing natural gas	1.67	4	2	2	
	EN-03	Water Reuse Potential	megaliters per day available	1.67	4	3	3	
	EN-04	Biomethane Resource Recovery	Recovery of biomethane resources	1.67	3	3	3	
	EN-05	Power (energy) usage	kilowatt hours per year consumed	1.67	3	4	3	Cost also included in EC-04
	EN-06	Transmission Reliability	risk cost of pump station failure	1.67	4	3	1	
	EN-07	Site Remediation	risk cost of site remediation	1.67	2	4	3	
	EN-08	Pollution Discharge	tons of pollutants discharged	1.67	3	3	3	
	EN-09	Non-renewable Resource Use	Gallons of diesel consumed per year	1.67	3	3	3	Cost also included in EC-04
	EN-10	Non-renewable Resource Generated	Struvite and biosolids production	1.67	3	3	3	
	EN-11	Flexibility for Future Resource Recovery	Additional space needed to add 100% additional resource recovery	1.67	2	3	3	
	EN-12	Terrestrial and Inter-tidal Effect	Habitat areas potentially disturbed	1.67	3	3	2	
Environmental Subtotal (100 pts max)¹:					63	63	55	
Social	SO-01	Impact of Property Values	Lost value to present community	1.82	3	3	3	
	SO-02	Operations Traffic in Sensitive Areas	Cost of traffic inconvenience during operations	1.82	1	3	3	
	SO-03	Operations Noise in Sensitive Areas	Cost of noise inconvenience	1.82	3	3	3	
	SO-04	Odour Potential	Cost of odour issues	1.82	2	4	4	
	SO-05	Visual Impacts	Cost of lost open water or territorial view	1.82	3	3	3	
	SO-06	Construction Disruption	Cost of traffic inconvenience due to construction	1.82	1	3	2	
	SO-07	Public and Stakeholder Acceptability	Lost time due to public disapproval	1.82	3	2	2	
	SO-08	Impacts on Future Development	Loss of value of developable land adjacent to plant	1.82	3	2	1	
	SO-09	Loss of Beneficial Site Uses	Loss of park land due to plant	1.82	4	3	2	
	SO-10	Compatibility with Designated Land Use	Delay due to zoning changes	1.82	3	3	3	
	SO-11	Cultural Resource Impacts	Risk cost of a cultural site find	1.82	3	2	2	
Social Subtotal (100 pts max)¹:					53	56	51	
TOTAL SCORE (300 pts max):					170	180	166	

¹ - Economic weighting is proportional to NPV results

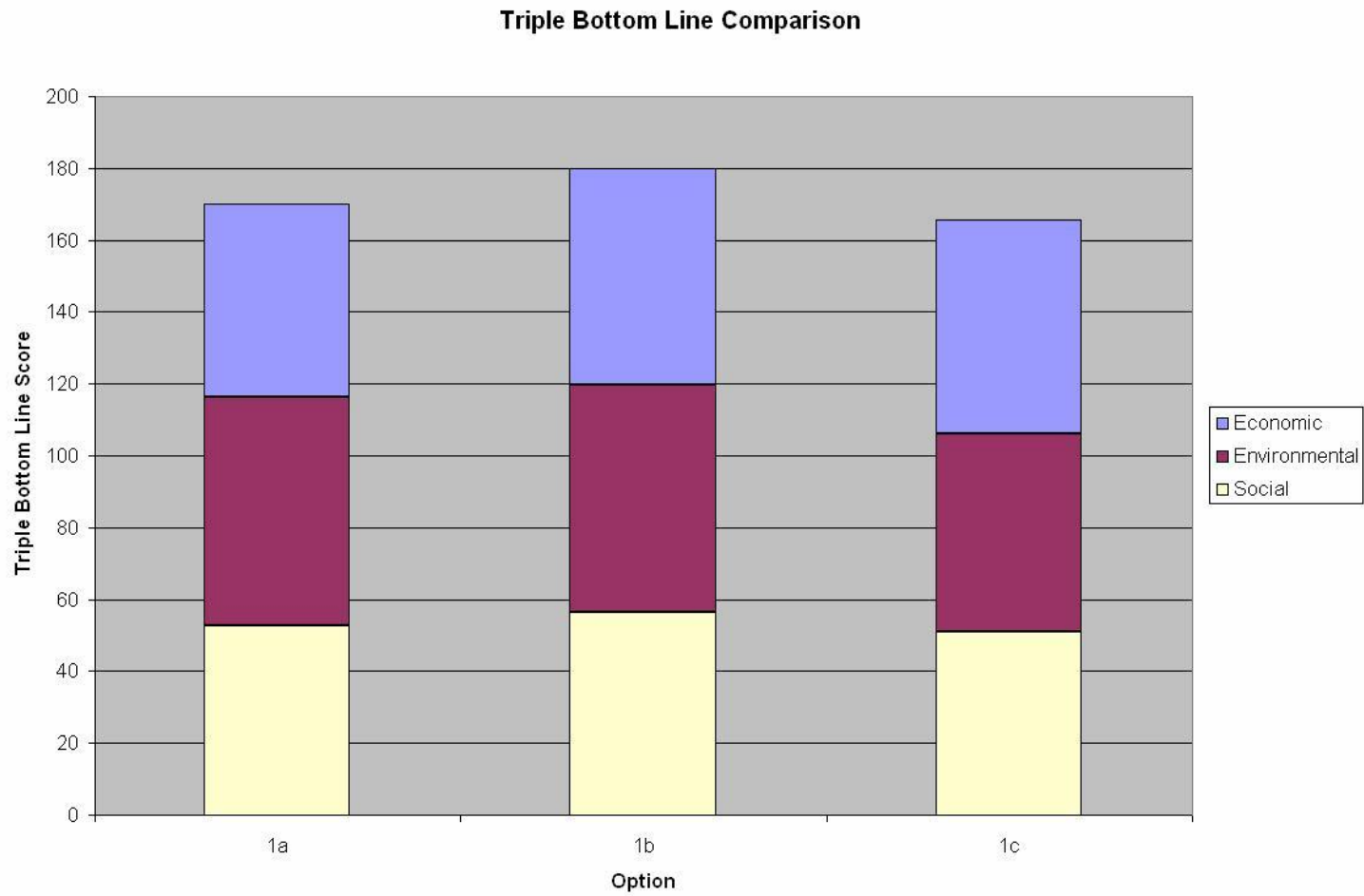

Figure 9.2
Graphical Results of TBL Analysis

Section 10 Risk Assessment of Option 1A, 1B, 1C

10.1 Methodology

Many communities are using risk assessment to identify and quantify the severity of risk associated with capital projects. Each project has a different risk profile. Quantification of risks can assist decision makers in the selection of options and identification and mitigation of project specific issues. For the CRD CAWTP the use of risk assessment provides a good technique to highlight the risks that are known at this time. As the project develops and more information becomes available the risk assessment can be updated and mitigation strategies can be developed for each of the identified risk factors.

Section 10.2 provides an outline of risks which are known for each of the options at this time. This risk matrix is preliminary only and will be further developed as the project proceeds.

10.2 Risk Matrix

A preliminary risk matrix has been prepared for each of the options under consideration and is provided in Table 10.1. A number of risk factors have been considered. These include siting risks, construction cost risk, constructability and a number of others. Each of these risks are ranked using a simple probability of occurrence using a 1 to 3 ranking. The risk impact is also ranked 1 – 3 with 1 being low impact and 3 being high impact. The factor of the probability and impact provides an overall risk factor. This technique is useful in providing a high level screening of risk factors. As the project develops more detailed risk assessment and workshops can be completed with various stakeholders and CRD staff.

10.3 Risk Ranking

Each option was ranked in consideration of the risk categories applicable to each of the options. The options considered risks associated with each site under consideration for construction of facilities. It also considers the risk associated with the various conveyance systems, social risks and construction risks.

Our assessment indicates that Option 1A has the highest risk (334) potential mainly due to the difficult construction conditions and the unknown associated with remediation of the site. Strategies can be developed to mitigate most of these risks but additional capital costs can be expected.

Options 1B (212) and 1C (206) have a similar risk profile and both have a lower risk profile and both have a lower risk profile than Option 1A. From a siting and construction risk perspective a plant on the West Shore has less risk than a plant at McLoughlin. Option 1B and 1C do however have added risks from tunnel crossings of Esquimalt Harbour.

RISK IDENTIFICATION			RISK ASSESSMENT			RISK MITIGATION
CATEGORY	RISK	DATE IDENTIFIED	PROB.	IMPACT	RISK FACTOR	RISK CONTROL STRATEGIES / ACTIONS
			HIGH = 3 MED = 2 LOW = 1	HIGH = 3 MED = 2 LOW = 1	HIGH > 5 MED 4 - 5 LOW < 4	
RISK – OPTION 1A						
Site	McLoughlin Point					
	<ul style="list-style-type: none"> Timing of Environmental Clean-up not within the project schedule 		3	3	9	
	<ul style="list-style-type: none"> Rezoning may not be approved 		2	3	6	
	<ul style="list-style-type: none"> Imperial Oil decides the site is too costly to remediate and does not sell 		1	3	3	
	<ul style="list-style-type: none"> Site Remediation Costs 		3	3	9	
	<ul style="list-style-type: none"> Access agreements with DND 		1	1	1	
	<ul style="list-style-type: none"> Aesthetics 		2	2	4	
	<ul style="list-style-type: none"> Rock Excavation 		3	3	9	
	<ul style="list-style-type: none"> Constructability 		3	3	9	
	<ul style="list-style-type: none"> Space 		3	3	9	
	<ul style="list-style-type: none"> Traffic 		1	1	1	
	<ul style="list-style-type: none"> Community Use 		1	1	1	
	<ul style="list-style-type: none"> Noise 		1	1	1	
	<ul style="list-style-type: none"> Odour Control 		1	2	2	
	<ul style="list-style-type: none"> Impacts on Adjacent Residents 		1	1	1	
Site	Saanich East - North Oak Bay					
	<ul style="list-style-type: none"> Site Purchase 		1	1	1	
	<ul style="list-style-type: none"> Noise 		1	2	2	
	<ul style="list-style-type: none"> Odour 		1	2	2	
	<ul style="list-style-type: none"> Visual Impacts 		1	2	2	
	<ul style="list-style-type: none"> Vibration 		1	2	2	
	<ul style="list-style-type: none"> Truck Traffic 		1	1	1	
	<ul style="list-style-type: none"> Impacts on Forest 		2	2	4	
	<ul style="list-style-type: none"> Environmental Impacts 		1	2	2	
	<ul style="list-style-type: none"> Wildlife Impacts 		1	2	2	
	<ul style="list-style-type: none"> Community Use 		2	2	4	
	<ul style="list-style-type: none"> Property Value Impact 		1	2	2	
Site	West Shore					

CAPITAL REGIONAL DISTRICT
 Core Area Wastewater Treatment Program
 Assessment of Wastewater Treatment – Options 1A, 1B and 1C

RISK IDENTIFICATION			RISK ASSESSMENT			RISK MITIGATION
CATEGORY	RISK	DATE IDENTIFIED	PROB.	IMPACT	RISK FACTOR	RISK CONTROL STRATEGIES / ACTIONS
			HIGH = 3 MED = 2 LOW = 1	HIGH = 3 MED = 2 LOW = 1	HIGH > 5 MED 4 - 5 LOW < 4	
	• Community Use		2	2	4	
	• Site Purchase		3	3	9	
	• Constructability		1	1	1	
	• Space		1	1	1	
	• Traffic		2	2	4	
	• Noise		1	2	2	
	• Odour Control		1	2	2	
	• Impacts on Adjacent Residents		2	2	4	
	• Space for Future Expansion		1	1	1	
Site	Clover Point					
	• Community Use		3	3	9	
	• Visual Impact		3	2	6	
	• Space		3	2	6	
	• Odour		1	2	2	
	• Noise		1	2	2	
	• Traffic		1	2	2	
	• Constructability		3	2	6	
	• Impact to Adjacent Residents		2	2	4	
Site	Macaulay Point					
	• Community Use		1	1	1	
	• Visual Impact		1	1	1	
	• Space		3	1	3	
	• Odour		1	2	2	
	• Noise		1	1	1	
	• Traffic		1	1	1	
	• Constructability		2	2	4	
	• Impact to Adjacent Residents		2	2	4	
Site	Inner Harbour Biosolids					
	• Community		2	3	6	
	• Visual Impact		3	2	6	
	• Space		3	3	9	
	• Odour		3	3	9	
	• Noise		2	2	4	
	• Traffic		3	3	9	
	• Constructability		3	2	6	
	• Impact to Adjacent Neighbours		3	2	6	

CAPITAL REGIONAL DISTRICT
 Core Area Wastewater Treatment Program
 Assessment of Wastewater Treatment – Options 1A, 1B and 1C

RISK IDENTIFICATION			RISK ASSESSMENT			RISK MITIGATION
CATEGORY	RISK	DATE IDENTIFIED	PROB.	IMPACT	RISK FACTOR	RISK CONTROL STRATEGIES / ACTIONS
			HIGH = 3 MED = 2 LOW = 1	HIGH = 3 MED = 2 LOW = 1	HIGH > 5 MED 4 - 5 LOW < 4	
Stakeholders	Acceptance		2	2	4	
	Mitigation Strategies / Costs		3	3	9	
	Social Concerns		3	2	6	
Engineering	Treatment Technology Selection		2	1	2	
	Resource Recovery		2	2	4	
	Foundation / Site Conditions		3	3	9	
	Carbon Footprint		1	1	1	
	Biosolids Treatment		3	3	9	
Financial	Capital Cost / Affordability		2	3	6	
	Operations / Maintenance Costs		1	2	2	
	Available Funding		2	3	6	
	Funding Conditions / Restrictions		2	2	4	
	Cost Escalation		2	3	6	
	Contingency Items		2	3	6	
	Financing Costs		1	1	1	
Procurement	Procurement Strategy		2	1	2	
Construction	Cost		2	3	6	
	Market Conditions		1	3	3	
	Schedule / Delays		2	3	6	
	Changes / Claims		2	2	4	
Other	Natural Disaster		1	3	3	
	Global Warming		1	1	1	
	Treatment System Failure		1	2	2	
	Transmission Failure		1	2	2	
	Archeological Conditions		2	2	4	
RISK - OPTION 1B						
Site	Saanich East - North Oak Bay					
	• Site Purchase		1	1	1	
	• Noise		1	2	2	
	• Odour		1	2	2	
	• Visual Impacts		1	2	2	

CAPITAL REGIONAL DISTRICT
 Core Area Wastewater Treatment Program
 Assessment of Wastewater Treatment – Options 1A, 1B and 1C

RISK IDENTIFICATION			RISK ASSESSMENT			RISK MITIGATION
CATEGORY	RISK	DATE IDENTIFIED	PROB.	IMPACT	RISK FACTOR	RISK CONTROL STRATEGIES / ACTIONS
			HIGH = 3 MED = 2 LOW = 1	HIGH = 3 MED = 2 LOW = 1	HIGH > 5 MED 4 - 5 LOW < 4	
	• Vibration		1	2	2	
	• Truck Traffic		1	1	1	
	• Impacts on Forest		2	2	4	
	• Environmental Impacts		1	2	2	
	• Wildlife Impacts		1	2	2	
	• Community Use		2	2	4	
	• Property Value Impact		1	2	2	
Site	West Shore					
	• Community Use		2	2	4	
	• Site Purchase		3	3	9	
	• Constructability		1	1	1	
	• Space		1	1	1	
	• Traffic		2	2	4	
	• Noise		1	2	2	
	• Odour Control		2	2	4	
	• Impacts on Adjacent Residents		1	1	1	
	• Space for Future Expansion					
Site	Clover Point					
	• Community Use		3	3	9	
	• Visual Impact		3	2	6	
	• Space		3	2	6	
	• Odour		1	2	2	
	• Noise		1	2	2	
	• Traffic		1	2	2	
	• Constructability		3	2	6	
	• Impact to Adjacent Residents		2	2	4	
Site	Macaulay Point					
	• Community		1	1	1	
	• Visual Impact		1	2	2	
	• Space		3	3	9	
	• Odour		1	2	2	
	• Noise		1	1	1	
	• Traffic		1	2	2	
	• Constructability		3	2	6	
	• Impact to Adjacent Residents		2	1	2	
Stakeholders	Acceptance		2	2	4	
	Mitigation Strategies / Costs		3	3	9	

CAPITAL REGIONAL DISTRICT
 Core Area Wastewater Treatment Program
 Assessment of Wastewater Treatment – Options 1A, 1B and 1C

RISK IDENTIFICATION			RISK ASSESSMENT			RISK MITIGATION
CATEGORY	RISK	DATE IDENTIFIED	PROB.	IMPACT	RISK FACTOR	RISK CONTROL STRATEGIES / ACTIONS
			HIGH = 3 MED = 2 LOW = 1	HIGH = 3 MED = 2 LOW = 1	HIGH > 5 MED 4 - 5 LOW < 4	
	Social Concerns		2	2	4	
Engineering	Treatment Technology Selection		1	2	2	
	Resource Recovery		2	1	2	
	Foundation / Site Conditions		3	2	6	
	Carbon Footprint		1	1	1	
	Biosolids Treatment		2	1	2	
Financial	Capital Cost / Affordability		2	2	4	
	Operations / Maintenance Costs		1	2	2	
	Available Funding		2	3	6	
	Funding Conditions / Restrictions		1	2	2	
	Cost Escalation		2	3	6	
	Contingency Items		2	3	6	
	Financing Costs		1	1	1	
Procurement	Procurement Strategy		2	2	4	
Construction	Cost		2	3	6	
	Market Conditions		1	3	3	
	Schedule / Delays		2	2	4	
	Changes / Claims		2	2	4	
Other	Natural Disaster		1	3	3	
	Global Warming		1	1	1	
	Treatment System Failure		1	2	2	
	Transmission Failure		2	3	6	
	Archeological Conditions		2	2	4	
	Security Risk Crossing to West Shore		2	3	6	
RISK - OPTION 1C						
Site	Saanich East - North Oak Bay					
	• Site Purchase		1	1	1	
	• Noise		1	2	2	
	• Odour		1	2	2	
	• Visual Impacts		1	2	2	
	• Vibration		1	2	2	
	• Truck Traffic		1	1	1	
	• Impacts on Forest		2	2	4	

CAPITAL REGIONAL DISTRICT
 Core Area Wastewater Treatment Program
 Assessment of Wastewater Treatment – Options 1A, 1B and 1C

RISK IDENTIFICATION			RISK ASSESSMENT			RISK MITIGATION
CATEGORY	RISK	DATE IDENTIFIED	PROB.	IMPACT	RISK FACTOR	RISK CONTROL STRATEGIES / ACTIONS
			HIGH = 3 MED = 2 LOW = 1	HIGH = 3 MED = 2 LOW = 1	HIGH > 5 MED 4 - 5 LOW < 4	
	• Environmental Impacts		1	2	2	
	• Wildlife Impacts		1	2	2	
	• Community Use		2	2	4	
	• Property Value Impact		1	2	2	
Site	West Shore					
	• Community Use		2	2	4	
	• Site Purchase		3	3	9	
	• Constructability		1	1	1	
	• Space		1	1	1	
	• Traffic		2	2	4	
	• Noise		1	2	2	
	• Odour Control		1	2	2	
	• Impacts on Adjacent Residents		2	2	4	
	• Space for Future Expansion		1	1	1	
Site	Clover Point					
	• Community Use		3	3	9	
	• Visual Impact		3	2	6	
	• Space		3	2	6	
	• Odour		1	2	2	
	• Noise		1	2	2	
	• Traffic		1	2	2	
	• Constructability		3	2	6	
	• Impact to Adjacent Residents		2	2	4	
Site	Macaulay Point					
	• Community		1	1	1	
	• Visual Impact		1	2	2	
	• Space		3	2	6	
	• Odour		1	2	2	
	• Noise		1	1	1	
	• Traffic		1	1	1	
	• Constructability		2	2	4	
	• Impact to Adjacent Residents		2	1	2	
Stakeholders	Acceptance		2	2	4	
	Mitigation Strategies / Costs		3	3	9	
	Social Concerns		2	2	4	
Engineering	Treatment Technology Selection		1	2	2	

CAPITAL REGIONAL DISTRICT
 Core Area Wastewater Treatment Program
 Assessment of Wastewater Treatment – Options 1A, 1B and 1C

RISK IDENTIFICATION			RISK ASSESSMENT			RISK MITIGATION
CATEGORY	RISK	DATE IDENTIFIED	PROB.	IMPACT	RISK FACTOR	RISK CONTROL STRATEGIES / ACTIONS
			HIGH = 3 MED = 2 LOW = 1	HIGH = 3 MED = 2 LOW = 1	HIGH > 5 MED 4 - 5 LOW < 4	
	Resource Recovery		2	2	2	
	Foundation / Site Conditions		3	2	6	
	Carbon Footprint		1	1	1	
	Biosolids Treatment		2	1	2	
Financial	Capital Cost / Affordability		2	2	4	
	Operations / Maintenance Costs		1	2	2	
	Available Funding		2	3	6	
	Funding Conditions / Restrictions		1	2	2	
	Cost Escalation		2	3	6	
	Contingency Items		2	3	6	
	Financing Costs		1	1	1	
Procurement	Procurement Strategy		2	2	4	
Construction	Cost		2	3	6	
	Market Conditions		1	3	3	
	Schedule / Delays		2	2	4	
	Changes / Claims		2	2	4	
Other	Natural Disaster		1	3	3	
	Global Warming		1	1	1	
	Treatment System Failure		1	2	2	
	Transmission Failure		2	3	6	
	Archeological Conditions		2	2	4	
	Security Risk Crossing to West Shore		2	3	6	

Section 11 Discussion of Analysis and Recommendation

11.1 Summary of Siting Investigations

Three options have been reviewed for provision of wastewater treatment to the Core Area. All options are capable of providing wastewater treatment to the Core Area. The CRD is fortunate to have several options available to them. All options have potential for recovery of resources from the liquid and biosolids treatment streams. Options 1B and 1C, located on the West Shore may provide the best flexibility in terms of long term site development, technology selection and ease of construction. They also provide sufficient space for integration of biosolids at a single site. The drawback to these sites is that conveyance facilities crossing the harbour are necessary to transport flows to the West Shore for treatment.

Option 1A, with the main secondary plant at McLoughlin Point is also a viable option because of its proximity to the Macaulay and Clover Point outfalls and the fact that the site is available for purchase. The McLoughlin site is contaminated and will require remediation. This presents some risk in terms of overall project schedule as the remediation process could take several years. There is also limited site availability and the construction conditions will be more costly. A separate site will be required for biosolids facilities. Potential sites have been identified in the upper Victoria inner harbour. Ideally, a site in closer proximity to the McLoughlin Point site would be preferred, with an expanded McLoughlin site the best biosolids siting scenario for Option 1A.

One of the biggest issues facing the CRD is the availability of plant sites large enough to fit both liquid and biosolids treatment facilities. This fact alone places significant constraints on the project. Ideally a site which is large enough for liquid and biosolids treatment trains (approximately 8-9 hectares) would be preferred, but such a site may not be readily available in the Core Area.

The potential for deferment of West Shore facilities under Option 1A, referred to as 1A prime, has also been investigated. There is an opportunity to defer the West Shore plant under Option 1A for a period of up to 10 years until such time that a new plant is constructed on the West Shore. The CRD together with the West Shore communities would have to commence siting and planning for these facilities within several years of completion of the McLoughlin Point Plant. Potential cost savings for the initial project by deferment of the West Shore facilities would be in the order of \$ 200 million, but there is a risk of losing senior government funding for the deferred plant on West Shore and costs could escalate in the future.

At the time of preparation of this report, siting studies are being completed by Westland Resource Group. The findings of these studies may have an impact on the final location of facilities and could impact the assessment of options. As such the CRD should continue to have at least two options available until such time that site availability is fully explored.

11.2 Siting of Biosolids Facilities

Ideally biosolids facilities should be located at the same site as the liquid train plant. This is only possible under Options 1B and 1C. For Option 1A it is unlikely that additional Federal lands could be obtained immediately adjacent to McLoughlin but this should be explored further. Siting options for biosolids facilities in the Upper Inner Victoria Harbour should also be explored. This would reduce the cost of sludge conveyance facilities and there would be opportunities for more economical distribution of recovered heat and reclaimed water by using common trench construction.

For Option 1A biosolids treatment facilities would likely have to be located at a site remote from McLoughlin in the Upper Inner Harbour or at another remote site. One potential site is the Hartland Landfill site. This site is located approximately 17 km from the McLoughlin Point and would require construction of a pumping station and pipeline to transfer sludge from the McLoughlin site to Harland landfill. The cost of the pumping station and pipelines would be \$20 million. The opportunity for heating digesters from secondary effluent would likely not be economical for this option. However the location of the digesters at Hartland would provide good synergies for integration of solid wastes with biosolids. It would also be a good location for acceptance of and processing of FOG and food wastes to enhance digester gas production. In the future, waste-to-energy facilities could also be integrated into this site more readily. This option will be investigated further as part of the development of the biosolids management plan which is currently under way.

11.3 Wet Weather Treatment Facilities

Under Option 1A initial investigation indicates that the Macaulay wet weather facilities can be incorporated into the McLoughlin Point plant, thereby resulting in cost savings. The footprint of the Clover Point facility is compact and can be accommodated adjacent to the Clover Point pump station. Because of the infrequency of use it is recommended the CRD continue negotiations with MOE for deferment of this plant. Funds may be better spent on reducing long term infiltration and inflow.

The wet weather facilities under Option 1B include facilities at Clover Point and Macaulay Point to provide primary treatment for flows from 2 to 4 x ADWF. These facilities can be constructed on CRD lands. As with Option 1A, deferment of facilities at Clover Point should be considered.

Under Option 1 C wet weather facilities are integrated into a large regional plant on the West Shore with all wet weather flows pumped from the Clover and Macaulay catchments to the West

Shore. This has the advantage of consolidating all facilities at one site however the conveyance and pumping facilities required to transfer the flow up to 4 x ADWF will be significant.

11.4 Resource Recovery & Carbon Footprint

The potential for resource recovery has been investigated and all options have a similar potential. The CRD has an opportunity to establish resource recovery facilities for reclaimed water, heat recovery, biomethane, soil amendment, struvite recovery and other resources. Further investigations are currently under way to assess these opportunities at Saanich East - North Oak Bay / UVic and James Bay.

One of the key drivers for implementation of resource recovery will be the market potential for immediate use of these resources. The market for use of these resources should be investigated further. It is suggested that resource recovery facilities be planned in a phased approach. Basic infrastructure can be configured to permit easy addition of resource recovery systems and specific facilities can then be constructed to match market demands.

The design for all options can be developed to offset greenhouse gases and provide a carbon positive project. By recovering heat, biomethane, reclaimed water and other resources the impact from operation at the plants and operating costs can be significantly reduced. One significant example is the recovery of heat from treated effluent to heat digesters and buildings. Studies are currently being completed to assess resource recovery options in the UVic and James Bay area.

11.5 Triple Bottom Line Assessment

A value-based triple bottom evaluation has been completed. Equal total weighting has provided for social, environmental and economic categories. The results of the TBL indicate relative scores of 170, 180 and 166 for Options 1A, 1B and 1C, respectively. Options 1A and 1B have a point spread of only 10 points. Option 1A has the advantage of using the McLoughlin site which may be available for purchase. A secondary advantage is the potential to receive interim flows from the West Shore for a period of 10 years until such time that the West Shore plant is constructed. This option would also result in significant deferred capital costs on the order of \$ 200 million, but future senior government funding for the deferred plant needs to be confirmed. If a commitment to future funding cannot be obtained then there is no advantage to deferment of this plant.

11.6 Recommendation

All three options are good and viable alternatives for providing the CRD with its regional wastewater treatment needs. Comparing alternatives, the only difference between Options 1B and 1C is the location of handling wet weather flows between 2 and 4 times ADWF. All other site and system components are the same. Despite their similarities, Option 1C rates significantly poorer than 1B on the TBL comparison, principally because of the larger

conveyance system for 1C. This results in higher costs, less conveyance reliability, and higher construction impacts. For this reason, it appears that of the two similar Options, 1B is more favourable and the project team recommends eliminating 1C from further consideration.

Detailed analysis indicates option 1B has the highest TBL ranking followed closely by 1A. The CRD has in our opinion two viable options, 1A and 1B which could be considered for implementation.

Comparing Options 1A and 1B, significant differences are evident with respect to location of treatment and resulting conveyance systems. Each has its pros and cons. Based on costs, risks, and the TBL evaluation, Option 1B is the best option. However, Option 1A is also a good and viable option. The capital cost of 1A is approximately \$ 90 million more than 1B and is significant. This capital cost difference may be reduced pending the outcome of further detailed investigations with respect to tunnel conveyance and remediation of the McLoughlin site under option 1A. If 1A prime is implemented, approximately \$200 million in capital investment would be deferred for 8 – 10 years.

The Option 1A costs and TBL ratings could be improved significantly with optimization. First, the biosolids facilities located at the inner harbour site separate from McLoughlin add appreciably to costs and lower TBL ratings. Purchasing more land closer to McLoughlin to allow biosolids processing could significantly reduce costs and impacts.

It should be noted that the final configuration of the wastewater system will be dictated by the success and results of site acquisition efforts.

Based on these considerations, the project team recommends the following:

1. Eliminate Option 1C from further consideration.
2. If the CRD has confidence that a site can be obtained on the West Shore, the preferred option is Option 1B and this should be carried forward in the LWMP Amendment. Option 1B is the lowest cost and highest scoring TBL option and would enable integration of all facilities at one site. However, if the Committee feels that governance and site availability will be a more severe issue on the West Shore, prohibiting timely implementation, then the CRD has the option of selecting Option 1A and carrying it forward in the LWMP.
3. Continue with the Business Case and grant application in consideration of the outcome of recommendation 2 above.
4. Continue to carry forward 1A and 1B until such time that detailed siting investigations and property negotiations are complete. This approach provides advantages to the CRD in the event that one option must be eliminated because of governance or site

availability issues. It also provides a fallback position in the event there are issues with site purchase under either option.

5. Proceed with acquisition of a West Shore site. A plant on the West Shore is part of both Options 1A and 1B.
6. Proceed with further technical development, site acquisition, and public consultation with the Saanich East - North Oak Bay Plant.
7. Proceed with further technical development and public consultation with the Clover Point pumping station, and conveyance pipelines.
8. Proceed to optimize Option 1A by exploring additional land for consolidation of biosolids processing with liquid stream treatment. This could include additional land adjacent to the McLoughlin site or a new site with sufficient size for consolidated facilities.
9. Continue to further develop resource recovery opportunities and explore the market potential for use of recovered resources.
10. Continue to further develop and explore opportunities for integrating biosolids and solid waste handling.
11. Continue to discuss the deferment or elimination of the Clover Point wet weather plant with the Provincial Ministry of Environment.

Appendix A

Triple Bottom Line Analysis

Criteria Group	No.	Criteria Categories	Measure Description	Weight	Option Results			Comments
					1a	1b	1c	
Economic	EC-01	Capital Costs	construction cost and markup for soft costs adjusted to midpoint of construction	8	2.5	2.7	2.7	Costs included for resource recovery systems
	EC-02	Capital Costs Eligible for Grants	Not available at this time	-	-	-	-	
	EC-03	Tax Revenue Implications	cost of private property lost and lost revenue from reduced property values	1	3	4	4	
	EC-04	Present Worth of O&M costs	O&M costs	8	2.7	2.8	2.7	Costs included for resource recovery systems
	EC-05	Flexibility for Future Treatment Process Optimization	cost of additional tankage needed for process optimization	1	3	4	4	
	EC-06	Expandability for Population Increases	additional space needed versus available to meet 2065 loading	1	3	4	4	
	EC-07	Flexibility to Accommodate Future Regulations	additional space needed versus available to meet potential regulations	1	3	4	4	
Economic Subtotal (100 pts max)¹:					54	60	60	
Environmental	EN-01	Carbon Footprint	tons of eCO2 created	1.67	4	4	4	
	EN-02	Heat Recovery Potential	Heat energy replacing natural gas	1.67	4	2	2	
	EN-03	Water Reuse Potential	megaliters per day available	1.67	4	3	3	
	EN-04	Biomethane Resource Recovery	Recovery of biomethane resources	1.67	3	3	3	
	EN-05	Power (energy) usage	kilowatt hours per year consumed	1.67	3	4	3	Cost also included in EC-04
	EN-06	Transmission Reliability	risk cost of pump station failure	1.67	4	3	1	
	EN-07	Site Remediation	risk cost of site remediation	1.67	2	4	3	
	EN-08	Pollution Discharge	tons of pollutants discharged	1.67	3	3	3	
	EN-09	Non-renewable Resource Use	Gallons of diesel consumed per year	1.67	3	3	3	Cost also included in EC-04
	EN-10	Non-renewable Resource Generated	Struvite and biosolids production	1.67	3	3	3	
	EN-11	Flexibility for Future Resource Recovery	Additional space needed to add 100% additional resource recovery	1.67	2	3	3	
	EN-12	Terrestrial and Inter-tidal Effect	Habitat areas potentially disturbed	1.67	3	3	2	
Environmental Subtotal (100 pts max):					63	63	55	
Social	SO-01	Impact of Property Values	Lost value to present community	1.82	3	3	3	
	SO-02	Operations Traffic in Sensitive Areas	Cost of traffic inconvenience during operations	1.82	1	3	3	
	SO-03	Operations Noise in Sensitive Areas	Cost of noise inconvenience	1.82	3	3	3	
	SO-04	Odour Potential	Cost of odour issues	1.82	2	4	4	
	SO-05	Visual Impacts	Cost of lost open water or territorial view	1.82	3	3	3	
	SO-06	Construction Disruption	Cost of traffic inconvenience due to construction	1.82	1	3	2	
	SO-07	Public and Stakeholder Acceptability	Lost time due to public disapproval	1.82	3	2	2	
	SO-08	Impacts on Future Development	Loss of value of developable land adjacent to plant	1.82	3	2	1	
	SO-09	Loss of Beneficial Site Uses	Loss of park land due to plant	1.82	4	3	2	
	SO-10	Compatibility with Designated Land Use	Delay due to zoning changes	1.82	3	3	3	
	SO-11	Cultural Resource Impacts	Risk cost of a cultural site find	1.82	3	2	2	
Social Subtotal (100 pts max):					53	56	51	
TOTAL SCORE (300 pts max):					170	180	166	

1 - Economic weighting is proportional to NPV results

Triple Bottom Line Comparison

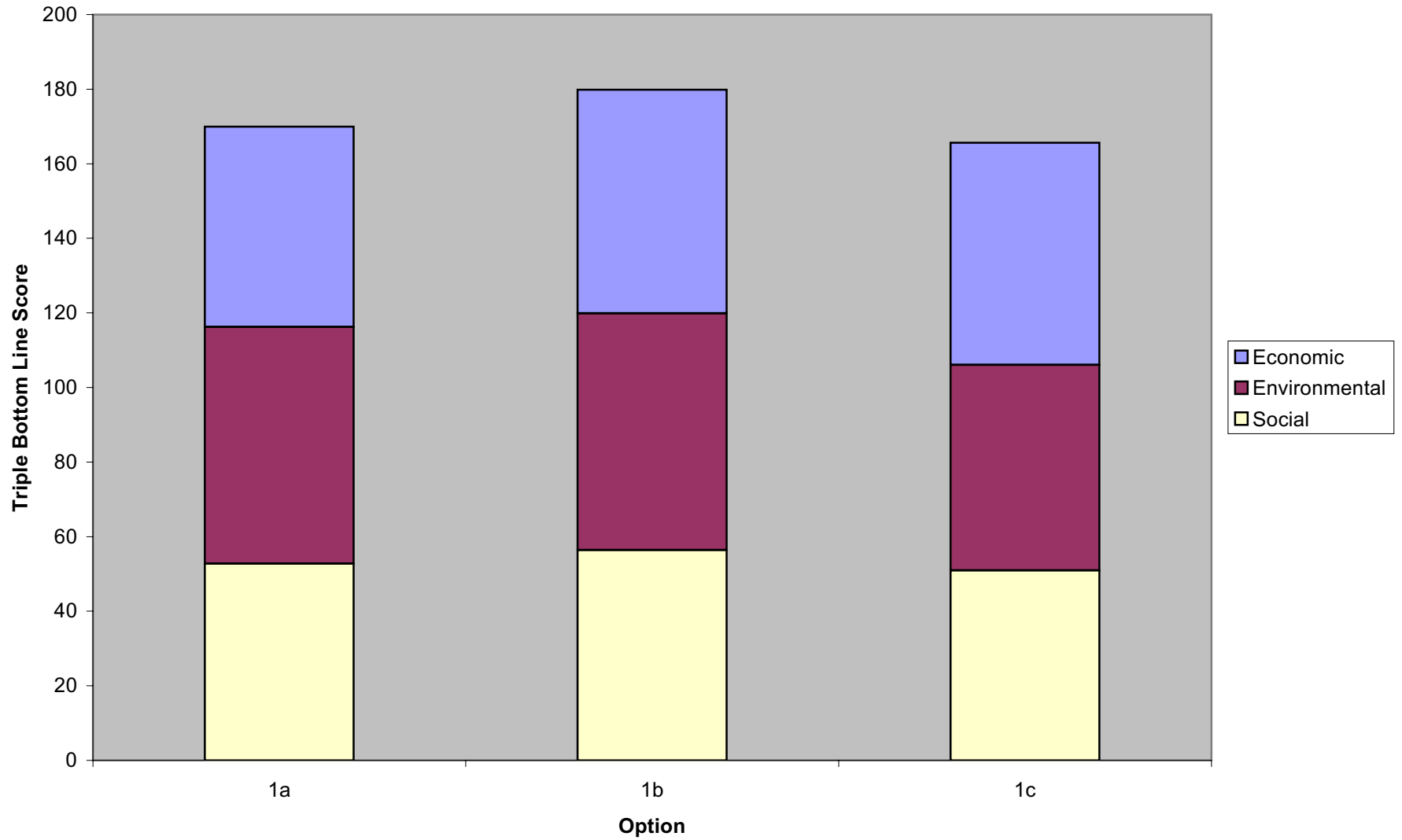

Commonly Used Assumptions:

Current Year:	2015
Baseline Year:	2065
Population growth rate:	0.38%
General Inflation:	3%
Inflation of Natural Gas:	5%
Inflation of Water Cost:	3%
Inflation of power costs:	3%
Operations Cost Inflation Rate:	3%
Cost of Natural Gas:	\$10.00 per gigajoule
Cost of Water:	\$0.72 per m ³
Cost per kW-hr	\$0.08 per kW-hr
Average Home Value	\$500,000 per home
Cost of additional land	\$2,000,000
1 tonne of CO ₂ e	valued at \$25

EC-01 Capital Costs

construction cost and markup for soft costs adjusted to midpoint of construction

<i>Estimated Construction Costs:</i>	Options		
	1a	1b	1c
Saanich:	\$146,555,300	\$146,555,300	\$146,555,300
Clover:	\$68,457,400	\$68,457,400	\$49,167,300
McLoughlin/Macaulay:	\$508,741,000	\$135,059,900	\$121,375,000
West Shore:	\$241,157,100	\$524,918,900	\$568,497,000
TOTAL:	\$964,910,800	\$874,991,500	\$885,594,600
SCORE:	2.49	2.74	2.71

Scoring: All scores proportional to \$800 million as

- 1
- 2
- 3 \$750 million
- 4
- 5



EC-02 Capital Costs Eligible for Grants

Grant fund information could not be confirmed at this time

EC-03 Tax Revenue Implications

loss property tax revenue from lost property

Land Purchase Price:	Options		
	1a	1b	1c
Saanich:	\$6,512,000	\$6,512,000	\$6,512,000
Clover:	\$0	\$0	\$0
McLoughlin/Macaulay:	\$4,000,000	\$0	\$0
West Shore:	\$10,000,000	\$10,000,000	\$10,000,000
Biosolids:	\$3,000,000	\$0	\$0
TOTAL:	\$23,512,000	\$16,512,000	\$16,512,000

Zoning replaced:	Options		
	1a	1b	1c
Saanich:	Institutional	Institutional	Institutional
Clover:	Park	Park	Park
McLoughlin/Macaulay:	Industrial	Industrial	Industrial
West Shore:	Industrial	Industrial	Industrial

Mill Rate	Options		
	1a	1b	1c
Saanich:	0.578%	0.578%	0.578%
Clover:	0.619%	0.619%	0.619%
McLoughlin/Macaulay:	4.294%	4.294%	4.294%
West Shore:	2.655%	2.655%	2.655%
Biosolids:	2.345%	-	-

Notes:

For East Saanich and Clover Point site, mill rate was based on an assumed lost residential area to replace current land use.

Calculation:

Lost Tax Revenue = Land Purchase Price
x mill rate

Lost Tax Revenue	Options		
	1a	1b	1c
Saanich:	\$37,639	\$37,639	\$37,639
Clover:	\$0	\$0	\$0
McLoughlin/Macaulay:	\$171,760	\$0	\$0
West Shore:	\$265,500	\$265,500	\$265,500
Biosolids:	\$70,350		
TOTAL:	\$545,249	\$303,139	\$303,139
SCORE:	3	3	3

NPV Calculation

Year	1a	1b	1c
2015	\$545,249	\$303,139	\$303,139
2016	\$534,864	\$297,365	\$297,365
2017	\$524,676	\$291,701	\$291,701
2018	\$514,682	\$286,145	\$286,145
2019	\$504,878	\$280,695	\$280,695
2020	\$495,262	\$275,348	\$275,348
2021	\$485,828	\$270,103	\$270,103
2022	\$476,574	\$264,958	\$264,958
2023	\$467,497	\$259,912	\$259,912
2024	\$458,592	\$254,961	\$254,961
2025	\$449,857	\$250,105	\$250,105
2026	\$441,288	\$245,341	\$245,341
2027	\$432,883	\$240,667	\$240,667
2028	\$424,637	\$236,083	\$236,083
2029	\$416,549	\$231,587	\$231,587
2030	\$408,615	\$227,175	\$227,175
2031	\$400,832	\$222,848	\$222,848
2032	\$393,197	\$218,603	\$218,603
2033	\$385,707	\$214,440	\$214,440
2034	\$378,360	\$210,355	\$210,355
2035	\$371,154	\$206,348	\$206,348
2036	\$364,084	\$202,418	\$202,418
2037	\$357,149	\$198,562	\$198,562
2038	\$350,346	\$194,780	\$194,780
2039	\$343,673	\$191,070	\$191,070
2040	\$337,127	\$187,431	\$187,431
2041	\$330,705	\$183,860	\$183,860
2042	\$324,406	\$180,358	\$180,358
2043	\$318,227	\$176,923	\$176,923
2044	\$312,166	\$173,553	\$173,553
2045	\$306,220	\$170,247	\$170,247
2046	\$300,387	\$167,004	\$167,004
2047	\$294,665	\$163,823	\$163,823
2048	\$289,052	\$160,703	\$160,703
2049	\$283,547	\$157,642	\$157,642
2050	\$278,146	\$154,639	\$154,639
2051	\$272,848	\$151,694	\$151,694
2052	\$267,651	\$148,804	\$148,804
2053	\$262,553	\$145,970	\$145,970
2054	\$257,552	\$143,190	\$143,190
2055	\$252,646	\$140,462	\$140,462
2056	\$247,834	\$137,787	\$137,787
2057	\$243,113	\$135,162	\$135,162
2058	\$238,482	\$132,588	\$132,588
2059	\$233,940	\$130,062	\$130,062
2060	\$229,484	\$127,585	\$127,585
2061	\$225,113	\$125,155	\$125,155
2062	\$220,825	\$122,771	\$122,771
2063	\$216,619	\$120,432	\$120,432
2064	\$212,492	\$118,138	\$118,138
2065	\$208,445	\$115,888	\$115,888
SUM	\$17,890,675	\$9,946,582	\$9,946,582

TOTAL:	Options		
	1a	1b	1c
\$17,890,675	\$9,946,582	\$9,946,582	
SCORE:	3	4	4

Scoring:

- 1 More than \$35 million
- 2 \$25 to \$35 million
- 3 \$15 to \$25 million
- 4 \$5 to \$15 million
- 5 Less than \$5 million

EC-04 Present Worth Costs

Present Worth costs of annual operation and maintenance costs over 50 years (includes refurbishment and replacement costs)

Annual O&M and R&R Costs:	Options		
	1a	1b	1c
Saanich:	\$2,885,300	\$2,885,300	\$2,885,300
Clover:	\$1,242,900	\$1,242,900	\$768,900
McLoughlin/Macaulay:	\$10,778,700	\$2,432,000	\$2,069,600
West Shore:	\$4,875,100	\$13,045,100	\$14,047,800
TOTAL:	\$19,782,000	\$19,605,300	\$19,771,600

This is 2030 load in 2009 dollars

\$36,800,347 \$36,471,633 \$36,781,000 This is 2030 load inflated to 2030 dollars
 \$17,701,596 \$17,543,479 \$17,692,290 This is 2030 load discounted to 2015 dollars

NPV Calculation

Year	1a	1b	1c
2015	\$22,314,424	\$22,115,103	\$22,302,692
2016	\$21,972,567	\$21,776,300	\$21,961,015
2017	\$21,635,947	\$21,442,687	\$21,624,572
2018	\$21,304,484	\$21,114,185	\$21,293,284
2019	\$20,978,100	\$20,790,716	\$20,967,071
2020	\$20,656,715	\$20,472,202	\$20,645,855
2021	\$20,340,254	\$20,158,568	\$20,329,561
2022	\$20,028,642	\$19,849,738	\$20,018,112
2023	\$19,721,803	\$19,545,640	\$19,711,434
2024	\$19,419,665	\$19,246,201	\$19,409,455
2025	\$19,122,155	\$18,951,349	\$19,112,102
2026	\$18,829,204	\$18,661,015	\$18,819,305
2027	\$18,540,741	\$18,375,128	\$18,530,993
2028	\$18,256,697	\$18,093,621	\$18,247,098
2029	\$17,977,004	\$17,816,427	\$17,967,553
2030	\$17,701,596	\$17,543,479	\$17,692,290
2031	\$17,430,408	\$17,274,713	\$17,421,244
2032	\$17,163,374	\$17,010,064	\$17,154,351
2033	\$16,900,431	\$16,749,470	\$16,891,546
2034	\$16,641,516	\$16,492,868	\$16,632,767
2035	\$16,386,568	\$16,240,198	\$16,377,953
2036	\$16,135,526	\$15,991,398	\$16,127,043
2037	\$15,888,330	\$15,746,410	\$15,879,977
2038	\$15,644,921	\$15,505,175	\$15,636,696
2039	\$15,405,241	\$15,267,635	\$15,397,142
2040	\$15,169,232	\$15,033,735	\$15,161,257
2041	\$14,936,840	\$14,803,418	\$14,928,987
2042	\$14,708,007	\$14,576,630	\$14,700,275
2043	\$14,482,681	\$14,353,316	\$14,475,067
2044	\$14,260,806	\$14,133,423	\$14,253,309
2045	\$14,042,330	\$13,916,899	\$14,034,948
2046	\$13,827,202	\$13,703,692	\$13,819,932
2047	\$13,615,369	\$13,493,752	\$13,608,211
2048	\$13,406,782	\$13,287,027	\$13,399,733
2049	\$13,201,390	\$13,083,470	\$13,194,449
2050	\$12,999,144	\$12,883,031	\$12,992,310
2051	\$12,799,998	\$12,685,663	\$12,793,268
2052	\$12,603,902	\$12,491,319	\$12,597,275
2053	\$12,410,810	\$12,299,952	\$12,404,285
2054	\$12,220,676	\$12,111,517	\$12,214,251
2055	\$12,033,455	\$11,925,968	\$12,027,129
2056	\$11,849,103	\$11,743,262	\$11,842,873
2057	\$11,667,575	\$11,563,356	\$11,661,441
2058	\$11,488,827	\$11,386,205	\$11,482,787
2059	\$11,312,819	\$11,211,768	\$11,306,871
2060	\$11,139,506	\$11,040,004	\$11,133,650
2061	\$10,968,849	\$10,870,871	\$10,963,082
2062	\$10,800,806	\$10,704,329	\$10,795,128
2063	\$10,635,338	\$10,540,339	\$10,629,747
2064	\$10,472,404	\$10,378,861	\$10,466,899
2065	\$10,311,967	\$10,219,857	\$10,306,546
TOTAL:	\$793,762,129	\$786,671,958	\$793,344,825
SCORE:	2.73	2.75	2.73

Scoring: All scores proportional to \$18 million
 1
 2
 3 \$18 Million
 4
 5

EC-05 Flexibility for Future Treatment Process Optimization

cost of additional tankage needed for process optimization

<i>Process Unit Structural Costs</i>	Options		
	1a	1b	1c
Saanich:	\$4,182,000	\$4,182,000	\$4,182,000
Clover:	\$1,062,000	\$1,062,000	\$0
McLoughlin/Macaulay:	\$26,788,964	\$555,000	\$0
West Shore:	\$24,899,389	\$49,117,109	\$50,725,109
TOTAL:	\$56,932,353	\$54,916,109	\$54,907,109

<i>Process Optimization Factor</i>	Options			
	1a	1b	1c	
Saanich:	0.90	0.90	0.90	Assumed MBR process
Clover:	1.00	1.00	1.00	Pump Station
McLoughlin/Macaulay:	0.80	1.00	1.00	Assumed BAF process
West Shore:	0.50	0.50	0.50	Assumed CAS process

Notes:

Lower process optimization factor means treatment process is easier to optimize

Calculation:

Optimization Cost = Structural Cost x Optimization Factor

<i>Process Unit Optimization Costs</i>	Options		
	1a	1b	1c
Saanich:	\$3,763,800	\$3,763,800	\$3,763,800
Clover:	\$1,062,000	\$1,062,000	\$0
McLoughlin/Macaulay:	\$21,431,171	\$555,000	\$0
West Shore:	\$12,449,694	\$24,558,554	\$25,362,554
TOTAL:	\$38,706,665	\$29,939,354	\$29,126,354
SCORE:	3	4	4

Scoring:

- 1 More than \$50 million
- 2 \$40 to \$50 million
- 3 \$30 to \$40 million
- 4 \$20 to \$30 million
- 5 Less than \$20 million

EC-06 Expandability for Population Increases

Cost of additional space needed to expand 100% from existing design loads

<u>Used Site Area (hectares):</u>	Options		
	1a	1b	1c
Saanich:	0.91	0.91	0.91
Clover:	0.59	0.59	0.20
McLoughlin/Macaulay:	3.15	0.50	0.14
West Shore:	3.57	6.09	6.09
TOTAL:	8.22	8.09	7.34

<u>Process Expansion Coefficient</u>	Options		
	1a	1b	1c
Saanich:	10%	10%	10%
Clover:	-	-	-
McLoughlin/Macaulay:	10%	-	-
West Shore:	40%	40%	40%

Assumes MBR Process
Pump Station
Assumes BAF Process
Assumes CAS Process

Assumptions: Value Reference/Basis
Cost of additional space: \$2,000,000 Per Hectare

Notes:

Process expansion coefficient is capacity increase achievable within original process tankage.

Calculation:

Cost to Expand = Site Area x (1 - Process Expansion Coefficient) x Cost of Additional Space

<u>Cost to Expand</u>	Options		
	1a	1b	1c
Saanich:	\$1,638,000	\$1,638,000	\$1,638,000
Clover:	-	-	-
McLoughlin/Macaulay:	\$5,670,000	-	-
West Shore:	\$4,284,000	\$7,308,000	\$7,308,000
TOTAL:	\$11,592,000	\$8,946,000	\$8,946,000
SCORE:	3	4	4

Scoring:

- 1 More than \$17 million
- 2 \$14 to \$17 million
- 3 \$11 to \$14 million
- 4 \$8 to \$11 million
- 5 Less than \$8 million

EC-07 Flexibility to Accommodate Future Regulations

<u>Process Unit Structural Costs</u>	Options		
	1a	1b	1c
Saanich:	\$4,182,000	\$4,182,000	\$4,182,000
Clover:	\$1,062,000	\$1,062,000	\$0
McLoughlin/Macaulay:	\$26,788,964	\$555,000	\$0
West Shore:	\$24,899,389	\$49,117,109	\$50,725,109
TOTAL:	\$56,932,353	\$54,916,109	\$54,907,109

<u>Process Optimization/Modification Factor</u>	Options		
	1a	1b	1c
Saanich:	0.90	0.90	0.90
Clover:	1.00	1.00	1.00
McLoughlin/Macaulay:	0.80	1.00	1.00
West Shore:	0.50	0.50	0.50

<u>Probability of stricter regulations:</u>	Options		
	1a	1b	1c
Saanich:	10%	10%	10%
Clover:	5%	5%	5%
McLoughlin/Macaulay:	25%	5%	5%
West Shore:	25%	25%	25%

Notes:
Lower process optimization/modification factor means more flexible

Calculation:

Future Regulation Cost = Structural Cost x Optimization/Modification Factor x Probability of Stricter Regulations **Scoring:**

	Options		
	1a	1b	1c
Saanich:	\$376,380	\$376,380	\$376,380
Clover:	\$53,100	\$53,100	\$0
McLoughlin/Macaulay:	\$5,357,793	\$27,750	\$0
West Shore:	\$3,112,424	\$6,139,639	\$6,340,639
TOTAL:	\$8,899,696	\$6,596,869	\$6,717,019
SCORE:	3	4	4

- 1 More than \$16 million
- 2 \$12 to \$16 million
- 3 \$8 to \$12 million
- 4 \$4 to \$8 million
- 5 Less than \$4 million

EN-01 Carbon Footprint

Value of offset carbon emissions

Components	Option 1a	Option 1b	Option 1c
Construction	15,516	9,935	9,935
Conveyance (assumed no direct GHG emissions for analysis)	0	0	0
Power for Conveyance (pumping)	183	514	832
Liquid Stream Treatment			
Power for Treatment	3,071	2,638	3,135
Power for Heat Pump	3,182	2,740	2,740
Direct emissions (CH4 & N2O)	12	12	12
Solids Treatment			
Power for Treatment (Biosolids treatment & Scrubbing)	1,213	858	858
Treatment Chemicals	195	251	251
Direct emissions (CH4 & N2O)	49	49	49
Power for soil amendment blending	12	12	12
Resources from WW			
Gas offsets (heat recovery for digester and drying)	0	0	0
Saleable Heat	-16,307	-13,853	-13,853
Biosolids fertilizer offset	-189	-189	-189
Carbon Sequestration (Soil amendment&Willow coppice)	-498	-498	-498
Dried Product fuel offset (cement kiln, etc.)	-1,742	-1,742	-1,742
Willow coppice offsets (burning wood)	-736	-736	-736
Biocell landfill gas offset	-851	-851	-851
Gas Sale Carbon Offset	-6,199	-6,199	-6,199
Struvite offsets	-250	-250	-250
Totals	-18,855	-17,244	-16,430
Annual cost of GHG emissions:	-\$471,375	-\$431,111	-\$410,747
NPV of GHG emissions:	-\$14,848,309	-\$13,579,987	-\$12,938,523

units for this sheet: Tonne CO2e/yr

Equations used:

Construction=EmissionsFactors*(Concrete+Steel(re-bar & equipment)+Excavation)
 Conveyance=undefinable
 Power for Treatment=Emissions*Electricity use
 Treatment Chemicals=EmissionsFactors*(Alum+Chlorine)
 DirectEmissions=MethaneEmissionsfromtreatment+MethaneEmissionsFromOutFall+NitrousOxideEmissionsFromOutFall
 Power for Solids Treatment = Power for treatment + Gas Scrubbing & Compression Power
 Treatment Chemicals=EmissionsFactors*(Polymer)
 Direct emissions (CH4 & N2O) = emissions of methane from digester/scrubber + emissions of N2O from effluent
 Power for soil blending= #ofsolidstoprocess*Liters required*diesel emissions
 Gas offsets = Naturalgas*(digester+drying+building heat)
 Biosolids fertiier=# of solids to soils*kgN*Noffset + solids*kg P*Poffset
 Carbon Sequestration=emissionsfactor for sequestration*# of solids applied (Willow coppice&Soil Amendment)
 1 tonne of CO2e valued at \$25
 NPV factor of 31.5 assumed

Equation notes

*note the offsets in terms of biosolids are the same for all options

*this doesn't take into account transport of the wood to the burning facility
 *need to input a biosolids to gas emission factor in numbers to be delivered page

Scoring:	
1	More than \$20 million
2	\$5 million to \$20 million
3	-\$5 million to \$5 million
4	-\$5 million to -\$20 million
5	Less than -\$20 million

EN-02 Heat Recovery Potential

Heat energy used to replace natural gas use

Assumptions: Value Reference/Basis
 Cost of Natural Gas: \$10.00 per gigajoule
 Inflation of Natural Gas: 5%

Note:
 This calculation is gross value of recovered heat, not revenue.
 Costs for supplying this heat are in other economic criteria

Projected Heat Recovery

Year	1a			1b/1c		
	E Saanich	McLoughlin	W Shore	E Saanich	McLoughlin	W Shore
2016	8870	43064	5925	8870	0	49270
2017	9951	48347	7009	9951	0	55020
2018	11163	54279	8290	11163	0	61441
2019	12523	60938	9807	12523	0	68612
2020	14048	68414	11600	14048	0	76619
2021	15760	76807	13722	15760	0	85561
2022	17680	86230	16231	17680	0	95547
2023	19834	96809	19200	19834	0	106697
2024	22250	108686	22712	22250	0	119150
2025	24961	122019	26865	24961	0	133055
2026	28002	136989	31779	28002	0	148583
2027	31413	153795	37591	31413	0	165924
2028	35240	172663	44466	35240	0	185288
2029	39534	193846	52598	39534	0	206912
2030	44350	217628	62218	44350	0	231060
2031	45624	223897	64792	45624	0	233798
2032	46934	230346	67472	46934	0	236568
2033	48282	236982	70263	48282	0	239371
2034	49669	243808	73170	49669	0	242208
2035	51095	250831	76197	51095	0	245078
2036	52563	258057	79349	52563	0	247981
2037	54072	265490	82632	54072	0	250920
2038	55625	273138	86050	55625	0	253893
2039	57223	281006	89610	57223	0	256901
2040	58866	289100	93317	58866	0	259945
2041	60557	297428	97177	60557	0	263026
2042	62296	305996	101197	62296	0	266142
2043	64085	314810	105384	64085	0	269296
2044	65925	323879	109743	65925	0	272487
2045	67819	333208	114283	67819	0	275715
2046	69767	342807	119011	69767	0	278982
2047	71770	352681	123934	71770	0	282288
2048	73831	362841	129061	73831	0	285633
2049	75952	373293	134400	75952	0	289017
2050	78133	384046	139960	78133	0	292442
2051	80377	395108	145750	80377	0	295907
2052	82686	406490	151780	82686	0	299413
2053	85060	418199	158059	85060	0	302961
2054	87503	430246	164597	87503	0	306551
2055	90016	442639	171406	90016	0	310183
2056	92601	455390	178497	92601	0	313859
2057	95261	468508	185881	95261	0	317578
2058	97997	482003	193571	97997	0	321341
2059	100811	495888	201579	100811	0	325148
2060	103707	510172	209918	103707	0	329001
2061	106685	524868	218602	106685	0	332899
2062	109749	539988	227645	109749	0	336844
2063	112901	555542	237062	112901	0	340835
2064	116143	571545	246869	116143	0	344874
2065	119479	588009	257082	119479	0	348960

Growth Rates

2015 to 2030	12.2%	12.3%	18.3%	12.2%	11.7%
2030 to 2065	2.9%	2.9%	4.1%	2.9%	1.2%

NPV Calculation

Year	1a	1b	1c
2016	\$814,134	\$818,088	\$818,088
2017	\$918,928	\$914,203	\$914,203
2018	\$1,037,482	\$1,021,613	\$1,021,613
2019	\$1,171,653	\$1,141,646	\$1,141,646
2020	\$1,323,553	\$1,275,785	\$1,275,785
2021	\$1,495,589	\$1,425,689	\$1,425,689
2022	\$1,690,508	\$1,593,211	\$1,593,211
2023	\$1,911,443	\$1,780,422	\$1,780,422
2024	\$2,161,973	\$1,989,637	\$1,989,637
2025	\$2,446,183	\$2,223,443	\$2,223,443
2026	\$2,768,749	\$2,484,731	\$2,484,731
2027	\$3,135,013	\$2,776,731	\$2,776,731
2028	\$3,551,095	\$3,103,056	\$3,103,056
2029	\$4,024,001	\$3,467,741	\$3,467,741
2030	\$4,561,763	\$3,875,295	\$3,875,295
2031	\$4,704,113	\$3,931,742	\$3,931,742
2032	\$4,851,017	\$3,989,160	\$3,989,160
2033	\$5,002,625	\$4,047,570	\$4,047,570
2034	\$5,159,091	\$4,106,991	\$4,106,991
2035	\$5,320,577	\$4,167,446	\$4,167,446
2036	\$5,487,248	\$4,228,955	\$4,228,955
2037	\$5,659,276	\$4,291,542	\$4,291,542
2038	\$5,836,837	\$4,355,229	\$4,355,229
2039	\$6,020,116	\$4,420,039	\$4,420,039
2040	\$6,209,301	\$4,485,997	\$4,485,997
2041	\$6,404,589	\$4,553,126	\$4,553,126
2042	\$6,606,183	\$4,621,451	\$4,621,451
2043	\$6,814,293	\$4,691,000	\$4,691,000
2044	\$7,029,135	\$4,761,796	\$4,761,796
2045	\$7,250,935	\$4,833,869	\$4,833,869
2046	\$7,479,924	\$4,907,245	\$4,907,245
2047	\$7,716,342	\$4,981,953	\$4,981,953
2048	\$7,960,438	\$5,058,022	\$5,058,022
2049	\$8,212,470	\$5,135,482	\$5,135,482
2050	\$8,472,703	\$5,214,363	\$5,214,363
2051	\$8,741,412	\$5,294,696	\$5,294,696
2052	\$9,018,882	\$5,376,514	\$5,376,514
2053	\$9,305,408	\$5,459,849	\$5,459,849
2054	\$9,601,295	\$5,544,735	\$5,544,735
2055	\$9,906,858	\$5,631,207	\$5,631,207
2056	\$10,222,424	\$5,719,301	\$5,719,301
2057	\$10,548,330	\$5,809,052	\$5,809,052
2058	\$10,884,926	\$5,900,497	\$5,900,497
2059	\$11,232,574	\$5,993,676	\$5,993,676
2060	\$11,591,648	\$6,088,627	\$6,088,627
2061	\$11,962,537	\$6,185,390	\$6,185,390
2062	\$12,345,640	\$6,284,007	\$6,284,007
2063	\$12,741,374	\$6,384,520	\$6,384,520
2064	\$13,150,169	\$6,486,972	\$6,486,972
2065	\$13,572,469	\$6,591,407	\$6,591,407
Sum	\$326,035,228	\$209,424,720	\$209,424,720

TOTAL:	Options		
	1a	1b	1c
\$326,035,228	\$209,424,720	\$209,424,720	\$209,424,720
SCORE:	4	2	2

Scoring:

- 1 Less than \$200 million
- 2 \$200 to \$250 million
- 3 \$250 to \$300 million
- 4 \$300 to \$350 million
- 5 More than \$350 million

EN-03 Water Reuse Potential

megaliters per day available

Water Replaced Annually (in ML)	Options		
	1a	1b	1c
Saanich:	420	420	420
Clover:	0	0	0
McLoughlin/Macaulay	360	0	0
West Shore:	410	410	410
TOTAL:	1,190	830	830

Assumptions: Value Reference/Basis
 Cost of Water: \$0.72 per cubic meter
 Inflation of Water Cost: 3%

Calculation:

Value of Reuse Water = Water Replaced x cost of water

	Options			
	1a	1b	1c	
Saanich:	\$302,400	\$302,400	\$302,400	
Clover:	\$0	\$0	\$0	
McLoughlin/Macaulay:	\$259,200	\$0	\$0	
West Shore:	\$295,200	\$295,200	\$295,200	
TOTAL:	\$856,800	\$597,600	\$597,600	2030 loading in 2009 \$
	\$1,593,900	\$1,111,712	\$1,111,712	2030 loading in 2030 \$
	\$766,693	\$534,752	\$534,752	2030 loading discounted to 2015 \$

NPV Calculation

Year	1a	1b	1c
2015	\$966,485	\$674,103	\$674,103
2016	\$951,678	\$663,775	\$663,775
2017	\$937,098	\$653,606	\$653,606
2018	\$922,742	\$643,593	\$643,593
2019	\$908,606	\$633,733	\$633,733
2020	\$894,686	\$624,025	\$624,025
2021	\$880,979	\$614,464	\$614,464
2022	\$867,483	\$605,051	\$605,051
2023	\$854,193	\$595,781	\$595,781
2024	\$841,106	\$586,654	\$586,654
2025	\$828,221	\$577,667	\$577,667
2026	\$815,532	\$568,817	\$568,817
2027	\$803,038	\$560,102	\$560,102
2028	\$790,736	\$551,522	\$551,522
2029	\$778,622	\$543,072	\$543,072
2030	\$766,693	\$534,752	\$534,752
2031	\$754,948	\$526,560	\$526,560
2032	\$743,382	\$518,493	\$518,493
2033	\$731,993	\$510,550	\$510,550
2034	\$720,779	\$502,728	\$502,728
2035	\$709,737	\$495,026	\$495,026
2036	\$698,864	\$487,443	\$487,443
2037	\$688,157	\$479,975	\$479,975
2038	\$677,614	\$472,622	\$472,622
2039	\$667,233	\$465,381	\$465,381
2040	\$657,011	\$458,252	\$458,252
2041	\$646,946	\$451,231	\$451,231
2042	\$637,035	\$444,318	\$444,318
2043	\$627,275	\$437,511	\$437,511
2044	\$617,665	\$430,809	\$430,809
2045	\$608,203	\$424,209	\$424,209
2046	\$598,885	\$417,710	\$417,710
2047	\$589,710	\$411,311	\$411,311
2048	\$580,676	\$405,009	\$405,009
2049	\$571,780	\$398,804	\$398,804
2050	\$563,020	\$392,695	\$392,695
2051	\$554,395	\$386,679	\$386,679
2052	\$545,901	\$380,755	\$380,755
2053	\$537,538	\$374,922	\$374,922
2054	\$529,303	\$369,178	\$369,178
2055	\$521,194	\$363,522	\$363,522
2056	\$513,210	\$357,953	\$357,953
2057	\$505,347	\$352,469	\$352,469
2058	\$497,605	\$347,069	\$347,069
2059	\$489,982	\$341,752	\$341,752
2060	\$482,475	\$336,516	\$336,516
2061	\$475,084	\$331,361	\$331,361
2062	\$467,806	\$326,285	\$326,285
2063	\$460,639	\$321,286	\$321,286
2064	\$453,582	\$316,364	\$316,364
2065	\$446,633	\$311,517	\$311,517
Sum	\$34,379,506	\$23,978,983	\$23,978,983

TOTAL:	Options		
	1a	1b	1c
	\$34,379,506	\$23,978,983	\$23,978,983
SCORE:	4	3	3

EN-03 Scoring:	
1	Less than \$10 million
2	\$10 to \$20 million
3	\$20 to \$30 million
4	\$30 to \$40 million
5	More than \$40 million

EN-04 Biomethane Resource Recovery

Recovery of biomethane resources

Biomethane Recovered Annually (in GJ)	Options		
	1a	1b	1c
Saanich:	-	-	-
Clover:	-	-	-
McLoughlin/Macaulay	98,590	-	-
West Shore:	24,647	123,237	123,237
TOTAL:	123,237	123,237	123,237

Codigestion Substrate Volume (in ML)	Options		
	1a	1b	1c
Saanich:	-	-	-
Clover:	-	-	-
McLoughlin/Macaulay	20,148	-	-
West Shore:	5,037	25,185	25,185
TOTAL:	25,185	25,185	25,185

Assumptions:	Value	Reference/Basis
Cost of Natural Gas:	\$10.00	per gigajoule
Inflation of Natural Gas:	5%	
Tipping fee:	\$0.035	per liter of FOG

Calculation:

Value of Biomethane = kJ recovered x cost of natural gas + tipping fees

	Options		
	1a	1b	1c
Saanich:	-	-	-
Clover:	-	-	-
McLoughlin/Macaulay	\$1,691,080	-	-
West Shore:	\$422,765	\$2,113,845	\$2,113,845
TOTAL:	\$2,113,845	\$2,113,845	\$2,113,845

2030 loading in 2009 \$

\$3,932,374 \$3,932,374 \$3,932,374 2030 loading inflated to 2030 \$
 \$1,891,539 \$1,891,539 \$1,891,539 2030 loading discounted to 2015 \$

NPV Calculation

Year	1a	1b	1c
2015	\$1,786,930	\$1,786,930	\$1,786,930
2016	\$1,793,720	\$1,793,720	\$1,793,720
2017	\$1,800,536	\$1,800,536	\$1,800,536
2018	\$1,807,378	\$1,807,378	\$1,807,378
2019	\$1,814,246	\$1,814,246	\$1,814,246
2020	\$1,821,141	\$1,821,141	\$1,821,141
2021	\$1,828,061	\$1,828,061	\$1,828,061
2022	\$1,835,007	\$1,835,007	\$1,835,007
2023	\$1,841,981	\$1,841,981	\$1,841,981
2024	\$1,848,980	\$1,848,980	\$1,848,980
2025	\$1,856,006	\$1,856,006	\$1,856,006
2026	\$1,863,059	\$1,863,059	\$1,863,059
2027	\$1,870,139	\$1,870,139	\$1,870,139
2028	\$1,877,245	\$1,877,245	\$1,877,245
2029	\$1,884,379	\$1,884,379	\$1,884,379
2030	\$1,891,539	\$1,891,539	\$1,891,539
2031	\$1,898,727	\$1,898,727	\$1,898,727
2032	\$1,905,942	\$1,905,942	\$1,905,942
2033	\$1,913,185	\$1,913,185	\$1,913,185
2034	\$1,920,455	\$1,920,455	\$1,920,455
2035	\$1,927,753	\$1,927,753	\$1,927,753
2036	\$1,935,078	\$1,935,078	\$1,935,078
2037	\$1,942,431	\$1,942,431	\$1,942,431
2038	\$1,949,813	\$1,949,813	\$1,949,813
2039	\$1,957,222	\$1,957,222	\$1,957,222
2040	\$1,964,659	\$1,964,659	\$1,964,659
2041	\$1,972,125	\$1,972,125	\$1,972,125
2042	\$1,979,619	\$1,979,619	\$1,979,619
2043	\$1,987,142	\$1,987,142	\$1,987,142
2044	\$1,994,693	\$1,994,693	\$1,994,693
2045	\$2,002,273	\$2,002,273	\$2,002,273
2046	\$2,009,881	\$2,009,881	\$2,009,881
2047	\$2,017,519	\$2,017,519	\$2,017,519
2048	\$2,025,186	\$2,025,186	\$2,025,186
2049	\$2,032,881	\$2,032,881	\$2,032,881
2050	\$2,040,606	\$2,040,606	\$2,040,606
2051	\$2,048,360	\$2,048,360	\$2,048,360
2052	\$2,056,144	\$2,056,144	\$2,056,144
2053	\$2,063,958	\$2,063,958	\$2,063,958
2054	\$2,071,801	\$2,071,801	\$2,071,801
2055	\$2,079,673	\$2,079,673	\$2,079,673
2056	\$2,087,576	\$2,087,576	\$2,087,576
2057	\$2,095,509	\$2,095,509	\$2,095,509
2058	\$2,103,472	\$2,103,472	\$2,103,472
2059	\$2,111,465	\$2,111,465	\$2,111,465
2060	\$2,119,489	\$2,119,489	\$2,119,489
2061	\$2,127,543	\$2,127,543	\$2,127,543
2062	\$2,135,627	\$2,135,627	\$2,135,627
2063	\$2,143,743	\$2,143,743	\$2,143,743
2064	\$2,151,889	\$2,151,889	\$2,151,889
2065	\$2,160,066	\$2,160,066	\$2,160,066
SUM	\$100,353,855	\$100,353,855	\$100,353,855

TOTAL:	Options		
	1a	1b	1c
\$100,353,855	\$100,353,855	\$100,353,855	\$100,353,855
SCORE:	3	3	3

- Scoring:**
- 1 Less than \$50 million
 - 2 \$50 to \$100 million
 - 3 \$100 to \$150 million
 - 4 \$150 to \$200 million
 - 5 More than \$200 million

EN-05 Power Energy Issues

2030 loading

Treatment Power Consumption:	Options		
	1a	1b	1c
Saanich	3,522,686	3,522,686	3,522,686
Clover	402,928	402,928	16,446
McLoughlin/Macaulay	27,018,721	455,007	16,446
West Shore	14,486,992	37,039,567	40,345,900
TOTAL:	45,431,327	41,420,178	47,801,478

Purging Power Consumption:	Options		
	1a	1b	1c
Saanich	196,537	196,537	196,537
Clover	570,240	570,240	968,571
McLoughlin/Macaulay	1,770,114	6,369,868	10,387,654
West Shore	-	-	-
TOTAL:	2,536,891	7,136,765	11,552,763

Heat Recovery Power Consumption:	Options		
	1a	1b	1c
Saanich	5,403,742	-	5,403,742
Clover	-	-	-
McLoughlin/Macaulay	30,293,708	-	-
West Shore	8,630,443	32,648,517	32,648,517
TOTAL:	44,107,893	38,650,239	38,650,239

Annual Power Cost:	Options		
	1a	1b	1c
Saanich	\$729,837	\$729,837	\$729,837
Clover	\$77,853	\$77,853	\$78,801
McLoughlin/Macaulay	\$4,726,800	\$546,000	\$632,338
West Shore	\$1,838,995	\$5,574,886	\$5,839,383
TOTAL:	\$7,373,485	\$6,928,576	\$7,480,360

\$13,716,489 \$12,889,193 \$13,915,673 2030 loading inflated to 2030 \$
 \$6,597,866 \$6,199,922 \$6,693,677 2030 loading discounted to 2015 \$

Assumptions:	Value	Reference/Basis
Cost per kW-hr	\$0.08	per kW-hr
Inflation of power costs:	3%	

NPV Calculation (without heat recovery)

Year	1a	1b	1c
2015	\$4,328,716	\$4,381,843	\$5,004,264
2016	\$4,282,400	\$4,314,713	\$4,927,599
2017	\$4,197,100	\$4,248,812	\$4,852,108
2018	\$4,132,800	\$4,183,823	\$4,777,774
2019	\$4,069,486	\$4,119,431	\$4,704,578
2020	\$4,007,141	\$4,056,322	\$4,632,504
2021	\$3,945,752	\$3,994,179	\$4,561,534
2022	\$3,885,303	\$3,932,988	\$4,491,651
2023	\$3,825,780	\$3,872,735	\$4,422,839
2024	\$3,767,169	\$3,813,404	\$4,355,081
2025	\$3,709,456	\$3,754,983	\$4,288,362
2026	\$3,652,627	\$3,697,457	\$4,222,664
2027	\$3,596,689	\$3,640,812	\$4,157,973
2028	\$3,541,568	\$3,585,034	\$4,094,273
2029	\$3,487,311	\$3,530,112	\$4,031,548
2030	\$3,433,885	\$3,476,030	\$3,969,785
2031	\$3,381,278	\$3,422,778	\$3,908,968
2032	\$3,329,477	\$3,370,341	\$3,849,082
2033	\$3,278,470	\$3,318,707	\$3,790,115
2034	\$3,228,243	\$3,267,864	\$3,732,050
2035	\$3,178,787	\$3,217,801	\$3,674,875
2036	\$3,130,088	\$3,168,504	\$3,618,576
2037	\$3,082,136	\$3,119,963	\$3,563,139
2038	\$3,034,916	\$3,072,165	\$3,508,552
2039	\$2,988,422	\$3,025,099	\$3,454,801
2040	\$2,942,639	\$2,978,755	\$3,401,873
2041	\$2,897,558	\$2,933,120	\$3,349,757
2042	\$2,853,167	\$2,888,185	\$3,298,438
2043	\$2,809,457	\$2,843,938	\$3,247,906
2044	\$2,766,416	\$2,800,369	\$3,198,148
2045	\$2,724,034	\$2,757,467	\$3,149,153
2046	\$2,682,302	\$2,715,223	\$3,100,908
2047	\$2,641,209	\$2,673,625	\$3,053,402
2048	\$2,600,746	\$2,632,665	\$3,006,624
2049	\$2,560,902	\$2,592,333	\$2,960,562
2050	\$2,521,689	\$2,552,618	\$2,915,206
2051	\$2,483,037	\$2,513,512	\$2,870,546
2052	\$2,444,997	\$2,475,005	\$2,826,569
2053	\$2,407,540	\$2,437,088	\$2,783,266
2054	\$2,370,656	\$2,399,752	\$2,740,626
2055	\$2,334,338	\$2,362,988	\$2,698,640
2056	\$2,298,576	\$2,326,787	\$2,657,297
2057	\$2,263,362	\$2,291,140	\$2,616,587
2058	\$2,228,687	\$2,256,040	\$2,576,501
2059	\$2,194,544	\$2,221,478	\$2,537,029
2060	\$2,160,923	\$2,187,445	\$2,498,161
2061	\$2,127,818	\$2,153,933	\$2,459,890
2062	\$2,095,220	\$2,120,935	\$2,422,204
2063	\$2,063,124	\$2,088,442	\$2,385,096
2064	\$2,031,514	\$2,056,447	\$2,348,556
2065	\$2,000,381	\$2,024,942	\$2,312,576
2066	\$1,969,726	\$1,993,928	\$2,277,156
2067	\$1,939,549	\$1,963,405	\$2,242,296
2068	\$1,909,850	\$1,933,373	\$2,207,996
2069	\$1,880,629	\$1,903,832	\$2,174,256
2070	\$1,851,886	\$1,874,781	\$2,141,076
2071	\$1,823,621	\$1,846,220	\$2,108,456
2072	\$1,795,834	\$1,818,159	\$2,076,396
2073	\$1,768,525	\$1,790,608	\$2,044,396
2074	\$1,741,704	\$1,763,567	\$2,012,456
2075	\$1,715,381	\$1,737,036	\$1,980,476
2076	\$1,689,556	\$1,711,015	\$1,948,456
2077	\$1,664,229	\$1,685,504	\$1,916,396
2078	\$1,639,400	\$1,660,503	\$1,884,396
2079	\$1,615,079	\$1,636,012	\$1,852,456
2080	\$1,591,266	\$1,612,031	\$1,820,476
2081	\$1,567,961	\$1,588,560	\$1,788,456
2082	\$1,545,164	\$1,565,609	\$1,756,396
2083	\$1,522,875	\$1,543,178	\$1,724,396
2084	\$1,501,094	\$1,521,267	\$1,692,456
2085	\$1,479,821	\$1,500,000	\$1,660,476
2086	\$1,459,056	\$1,479,289	\$1,629,456
2087	\$1,438,799	\$1,459,134	\$1,598,396
2088	\$1,419,050	\$1,439,535	\$1,567,396
2089	\$1,399,809	\$1,420,492	\$1,536,396
2090	\$1,381,076	\$1,402,007	\$1,505,396
2091	\$1,362,751	\$1,384,082	\$1,474,396
2092	\$1,344,834	\$1,366,717	\$1,443,396
2093	\$1,327,325	\$1,349,922	\$1,412,396
2094	\$1,310,224	\$1,333,697	\$1,381,396
2095	\$1,293,531	\$1,318,042	\$1,350,396
2096	\$1,277,246	\$1,302,957	\$1,320,396
2097	\$1,261,369	\$1,288,442	\$1,290,396
2098	\$1,245,890	\$1,274,507	\$1,260,396
2099	\$1,230,809	\$1,261,152	\$1,230,396
2100	\$1,216,126	\$1,248,377	\$1,200,396
2101	\$1,201,841	\$1,236,182	\$1,170,396
2102	\$1,187,954	\$1,224,567	\$1,140,396
2103	\$1,174,465	\$1,213,532	\$1,110,396
2104	\$1,161,374	\$1,203,077	\$1,080,396
2105	\$1,148,681	\$1,193,202	\$1,050,396
2106	\$1,136,386	\$1,183,907	\$1,020,396
2107	\$1,124,489	\$1,175,192	\$990,396
2108	\$1,112,990	\$1,167,057	\$960,396
2109	\$1,101,889	\$1,159,502	\$930,396
2110	\$1,091,186	\$1,152,527	\$900,396
2111	\$1,080,881	\$1,146,132	\$870,396
2112	\$1,070,974	\$1,140,317	\$840,396
2113	\$1,061,465	\$1,135,082	\$810,396
2114	\$1,052,354	\$1,130,427	\$780,396
2115	\$1,043,641	\$1,126,352	\$750,396
2116	\$1,035,326	\$1,122,857	\$720,396
2117	\$1,027,409	\$1,119,942	\$690,396
2118	\$1,019,890	\$1,117,607	\$660,396
2119	\$1,012,769	\$1,115,852	\$630,396
2120	\$1,006,046	\$1,114,677	\$600,396
2121	\$1,000,000	\$1,114,000	\$570,396
2122	\$994,731	\$1,113,821	\$540,396
2123	\$989,239	\$1,114,140	\$510,396
2124	\$984,524	\$1,114,957	\$480,396
2125	\$979,586	\$1,116,272	\$450,396
2126	\$975,425	\$1,118,087	\$420,396
2127	\$971,041	\$1,120,402	\$390,396
2128	\$967,434	\$1,123,217	\$360,396
2129	\$963,604	\$1,126,532	\$330,396
2130	\$959,551	\$1,130,347	\$300,396
2131	\$955,276	\$1,134,662	\$270,396
2132	\$950,779	\$1,139,477	\$240,396
2133	\$946,060	\$1,144,792	\$210,396
2134	\$941,119	\$1,150,607	\$180,396
2135	\$936,956	\$1,156,922	\$150,396
2136	\$932,571	\$1,163,737	\$120,396
2137	\$927,964	\$1,171,052	\$90,396
2138	\$923,135	\$1,178,867	\$60,396
2139	\$918,084	\$1,187,182	\$30,396
2140	\$912,811	\$1,196,007	\$0,396
2141	\$907,316	\$1,205,342	
2142	\$901,600	\$1,215,187	
2143	\$895,663	\$1,225,542	
2144	\$889,505	\$1,236,407	
2145	\$883,126	\$1,247,782	
2146	\$876,526	\$1,259,667	
2147	\$869,704	\$1,272,062	
2148	\$862,661	\$1,284,967	
2149	\$855,397	\$1,298,382	
2150	\$847,914	\$1,312,307	
2151	\$840,211	\$1,326,742	
2152	\$832,288	\$1,341,687	
2153	\$824,145	\$1,357,142	
2154	\$815,782	\$1,373,107	
2155	\$807,199	\$1,389,582	
2156	\$798,396	\$1,406,567	
2157	\$789,273	\$1,424,062	
2158	\$779,930	\$1,442,067	
2159	\$770,367	\$1,460,582	
2160	\$760,584	\$1,479,607	
2161	\$750,581	\$1,499,142	
2162	\$740,358	\$1,519,187	
2163	\$729,915	\$1,539,742	
2164	\$719,252	\$1,560,807	
2165	\$708,369	\$1,582,382	
2166	\$697,266	\$1,604,467	
2167	\$685,943	\$1,627,062	
2168	\$674,400	\$1,650,167	
2169	\$662,637	\$1,673,782	
2170	\$650,654	\$1,697,907	
2171	\$638,451	\$1,722,542	
2172	\$626,028	\$1,747,687	
2173	\$613,385	\$1,773,342	
2174	\$600,522	\$1,800,507	
2175	\$587,439	\$1,828,182	
2176	\$574,136	\$1,856,367	
2177	\$560,613	\$1,885,062	
2178	\$546,870	\$1,914,267	
2179	\$532,907	\$1,943,982	
2180	\$518,724	\$1,974,207	
2181	\$504,321	\$2,004,942	
2182	\$489,698	\$2,036,187	
2183	\$474,855	\$2,067,942	
2184	\$459,792	\$2,100,207	
2185	\$444,509	\$2,132,982	
2186	\$429,006	\$2,166,267	
2187	\$413,283	\$2,200,062	
2188	\$397,340	\$2,234,267	
2189	\$381,177	\$2,268,882	
2190	\$364,794	\$2,303,907	
2191	\$348,191	\$2,339,342	
2192	\$331,368	\$2,375,187	
2193	\$314,325	\$2,411,442	
2194	\$297,062	\$2,448,107	
2195	\$279,579	\$2,485,182	
2196	\$261,876	\$2,522,667	
2197	\$243,953	\$2,560,562	
2198	\$225,810	\$2,598,867	
2199	\$207,447	\$2,637,582	
2200	\$188,864	\$2,676,707	
2201	\$169,061	\$2,716,242	
2202	\$148,038	\$2,756,187	
2203	\$126,795	\$2,796,542	
2204	\$105,332	\$2,837,307	
2205	\$83,649	\$2,878,482	
2206	\$61,746	\$2,919,967	
2207	\$39,623	\$2,961,762	
2208	\$17,280	\$3,003,867	
2209	-\$5,183	\$3,046,282	
2210	-\$27,626	\$3,089,007	
2211	-\$50,069	\$3,132,042	
2212	-\$72,512	\$3,175,387	
2213	-\$94,955	\$3,219,042	
2214	-\$117,398	\$3,262,997	
2215	-\$139,841	\$3,307,262	
2216			

EN-06 Transmission Reliability

risk cost of pump station and pipeline failure

<i>Inputs:</i>	Options			
	1a	1b	1c	
Number of Stations	4	3	3	
Length of Biosolids Pipe:	3.2	-	-	km
Biosolids Volume Pumped:	0.7	0	0	ML/day
Length of Wastewater Pipe	3.3	5.9	5.9	km
Peak Liquid Volume Pumped	74	167	333	ML/day

Notes:

Biosolids pumped is from McLoughlin to the Biosolids Processing Site. Assumed to be 80% of the 300 ML/year produced in 1a.

Risk cost of \$300 per ML-km/day assumed

NPV factor of 31.5 used

<i>Length Times Volume</i>	Options		
	1a	1b	1c
TOTAL:	246	985	1,965

<i>Transmission Reliability NPV</i>	Options		
	1a	1b	1c
SCORE:	4	3	1

Scoring:

- 1 More than \$15 million
- 2 \$10 to \$15 million
- 3 \$5 to \$10 million
- 4 \$2 to \$5 million
- 5 Less than \$2 million

EN-07 Site Remediation

Risk cost of remediation activities and delays

<u>Estimated Construction Cost:</u>	Options		
	1a	1b	1c
Saanich:	\$146,555,300	\$146,555,300	\$146,555,300
Clover:	\$68,457,400	\$68,457,400	\$49,167,300
McLoughlin/Macaulay:	\$508,741,000	\$135,059,900	\$121,375,000
West Shore:	\$241,157,100	\$524,918,900	\$568,497,000
TOTAL:	\$964,910,800	\$874,991,500	\$885,594,600

<u>Delay Caused by Remediation:</u>	Options		
	1a	1b	1c
Saanich:	1	1	1
Clover:	1	1	1
McLoughlin/Macaulay:	1	1	1
West Shore:	1	1	1

<u>Probability of Delay:</u>	Options		
	1a	1b	1c
Saanich:	0%	0%	0%
Clover:	0%	0%	0%
McLoughlin/Macaulay:	75%	0%	0%
West Shore:	25%	25%	40%

<u>Site Area Requiring Remediation:</u>	Options		
	1a	1b	1c
Saanich:	1.80	1.80	1.80
Clover:	0.00	0.00	0.00
McLoughlin/Macaulay:	2.40	0.00	0.00
West Shore:	4.70	7.70	7.70
TOTAL:	8.90	9.50	9.50

Assumptions: Value Reference/Basis
 Cost per hectare of remediation: \$300,000 per hectare

Calculation:

Remediation Cost = Probability of Delay x [Construction Cost x (1 + inflation)ⁿ Delay Period + Direct Cost of Remediation]

	Options		
	1a	1b	1c
Saanich:	\$0	\$0	\$0
Clover:	\$0	\$0	\$0
McLoughlin/Macaulay:	\$11,986,673	\$0	\$0
West Shore:	\$2,161,178	\$4,514,392	\$7,745,964
TOTAL:	\$14,147,851	\$4,514,392	\$7,745,964
SCORE:	2	4	3

EN-07 Scoring:

1	More than \$15 million
2	\$11 to \$15 million
3	\$7 to \$11 million
4	\$3 to \$7 million
5	Less than \$3 million

EN-08 Pollution Discharge

Tons of pollutant discharged

	Options			mg/L
	1a	1b	1c	
Total Suspended Solids Concentration				
Saanich:	5	5	5	
Clover:	-	-	-	
McLoughlin/Macaulay:	15	-	-	
West Shore:	15	15	15	

	Options			ML/day
	1a	1b	1c	
Average Dry Weather Flow				
Saanich:	16.6	16.6	16.6	
Clover:	0	0	0	
McLoughlin/Macaulay:	84.15	0	0	
West Shore:	23.14	107.29	107.29	
TOTAL:	124	124	124	

Note: using SS as a surrogate for all solid pollutants
Assumed a \$1 per kg/day value for solids discharged

	Options			kg/day
	1a	1b	1c	
Mass Discharge:				
Saanich:	83	83	83	
Clover:	-	-	-	
McLoughlin/Macaulay:	1262	-	-	
West Shore:	347	1609	1609	
TOTAL:	1,692	1,692	1,692	

	Options			2030 loading (2009 \$)
	1a	1b	1c	
Cost of Mass Discharge:				
Saanich:	\$30,295	\$30,295	\$30,295	
Clover:	-	-	-	
McLoughlin/Macaulay:	\$460,721	-	-	
West Shore:	\$126,692	\$587,413	\$587,413	
TOTAL:	\$617,708	\$617,708	\$617,708	

\$1,149,118 \$1,149,118 \$1,149,118 2030 loading inflated to 2030 \$
\$552,746 \$552,746 \$552,746 2030 loading discounted to 2015 \$

NPV Calculation

Year	1a	1b	1c
2015	\$696,785	\$696,785	\$696,785
2016	\$686,110	\$686,110	\$686,110
2017	\$675,599	\$675,599	\$675,599
2018	\$665,248	\$665,248	\$665,248
2019	\$655,057	\$655,057	\$655,057
2020	\$645,021	\$645,021	\$645,021
2021	\$635,140	\$635,140	\$635,140
2022	\$625,409	\$625,409	\$625,409
2023	\$615,828	\$615,828	\$615,828
2024	\$606,394	\$606,394	\$606,394
2025	\$597,104	\$597,104	\$597,104
2026	\$587,956	\$587,956	\$587,956
2027	\$578,948	\$578,948	\$578,948
2028	\$570,079	\$570,079	\$570,079
2029	\$561,345	\$561,345	\$561,345
2030	\$552,746	\$552,746	\$552,746
2031	\$544,278	\$544,278	\$544,278
2032	\$535,939	\$535,939	\$535,939
2033	\$527,729	\$527,729	\$527,729
2034	\$519,644	\$519,644	\$519,644
2035	\$511,683	\$511,683	\$511,683
2036	\$503,844	\$503,844	\$503,844
2037	\$496,125	\$496,125	\$496,125
2038	\$488,524	\$488,524	\$488,524
2039	\$481,040	\$481,040	\$481,040
2040	\$473,671	\$473,671	\$473,671
2041	\$466,414	\$466,414	\$466,414
2042	\$459,269	\$459,269	\$459,269
2043	\$452,233	\$452,233	\$452,233
2044	\$445,304	\$445,304	\$445,304
2045	\$438,482	\$438,482	\$438,482
2046	\$431,765	\$431,765	\$431,765
2047	\$425,150	\$425,150	\$425,150
2048	\$418,637	\$418,637	\$418,637
2049	\$412,223	\$412,223	\$412,223
2050	\$405,908	\$405,908	\$405,908
2051	\$399,690	\$399,690	\$399,690
2052	\$393,566	\$393,566	\$393,566
2053	\$387,537	\$387,537	\$387,537
2054	\$381,600	\$381,600	\$381,600
2055	\$375,754	\$375,754	\$375,754
2056	\$369,997	\$369,997	\$369,997
2057	\$364,329	\$364,329	\$364,329
2058	\$358,747	\$358,747	\$358,747
2059	\$353,251	\$353,251	\$353,251
2060	\$347,839	\$347,839	\$347,839
2061	\$342,511	\$342,511	\$342,511
2062	\$337,263	\$337,263	\$337,263
2063	\$332,096	\$332,096	\$332,096
2064	\$327,009	\$327,009	\$327,009
2065	\$321,999	\$321,999	\$321,999
SUM	\$24,785,816	\$24,785,816	\$24,785,816

	Options		
	1a	1b	1c
TOTAL:	\$24,785,816	\$24,785,816	\$24,785,816
SCORE:	3	3	3

- Scoring:**
- 1 More than \$40 million
 - 2 \$30 to \$40 million
 - 3 \$20 to \$30 million
 - 4 \$10 to \$20 million
 - 5 Less than \$10 million

EN-09 Non-renewable Resource Use

Diesel fuel consumption during construction and operations

<u>Construction Cost:</u>	Options		
	1a	1b	1c
Saanich:	\$146,555,300	\$146,555,300	\$146,555,300
Clover:	\$68,457,400	\$68,457,400	\$49,167,300
McLoughlin/Macaulay:	\$508,741,000	\$135,059,900	\$121,375,000
West Shore:	\$241,157,100	\$524,918,900	\$568,497,000
TOTAL:	\$964,910,800	\$874,991,500	\$885,594,600

<u>Annual Operations Cost:</u>	Options		
	1a	1b	1c
Saanich:	\$2,885,300	\$2,885,300	\$2,885,300
Clover:	\$1,242,900	\$1,242,900	\$768,900
McLoughlin/Macaulay:	\$10,778,700	\$2,432,000	\$2,069,600
West Shore:	\$4,875,100	\$13,045,100	\$14,047,800
TOTAL:	\$19,782,000	\$19,605,300	\$19,771,600

<u>Assumptions:</u>	Value	Reference/Basis
Operations Cost Inflation Rate:	3%	
Percent of Construction for Diesel:	2%	
Percent of Operations for Diesel:	2%	

NPV Calculation:

Year	1a	1b	1c
2015	\$19,770,631	\$17,968,025	\$18,184,058
2016	\$486,587	\$482,241	\$486,331
2017	\$479,133	\$474,853	\$478,881
2018	\$471,792	\$467,578	\$471,544
2019	\$464,565	\$460,415	\$464,320
2020	\$457,447	\$453,361	\$457,207
2021	\$450,439	\$446,416	\$450,203
2022	\$443,539	\$439,577	\$443,305
2023	\$436,744	\$432,842	\$436,514
2024	\$430,053	\$426,211	\$429,827
2025	\$423,464	\$419,682	\$423,242
2026	\$416,977	\$413,252	\$416,758
2027	\$410,589	\$406,921	\$410,373
2028	\$404,299	\$400,687	\$404,086
2029	\$398,105	\$394,549	\$397,895
2030	\$392,006	\$388,504	\$391,800
2031	\$386,000	\$382,552	\$385,797
2032	\$380,087	\$376,692	\$379,887
2033	\$374,264	\$370,921	\$374,067
2034	\$368,530	\$365,238	\$368,336
2035	\$362,884	\$359,643	\$362,693
2036	\$357,325	\$354,133	\$357,137
2037	\$351,851	\$348,708	\$351,666
2038	\$346,460	\$343,365	\$346,278
2039	\$341,152	\$338,105	\$340,973
2040	\$335,926	\$332,925	\$335,749
2041	\$330,780	\$327,825	\$330,606
2042	\$325,712	\$322,803	\$325,541
2043	\$320,722	\$317,857	\$320,554
2044	\$315,809	\$312,988	\$315,643
2045	\$310,970	\$308,193	\$310,807
2046	\$306,206	\$303,471	\$306,045
2047	\$301,515	\$298,822	\$301,357
2048	\$296,896	\$294,244	\$296,740
2049	\$292,348	\$289,736	\$292,194
2050	\$287,869	\$285,298	\$287,718
2051	\$283,459	\$280,927	\$283,310
2052	\$279,116	\$276,623	\$278,969
2053	\$274,840	\$272,385	\$274,696
2054	\$270,630	\$268,212	\$270,487
2055	\$266,484	\$264,103	\$266,343
2056	\$262,401	\$260,057	\$262,263
2057	\$258,381	\$256,073	\$258,245
2058	\$254,423	\$252,150	\$254,289
2059	\$250,525	\$248,287	\$250,393
2060	\$246,687	\$244,483	\$246,557
2061	\$242,908	\$240,738	\$242,780
2062	\$239,186	\$237,050	\$239,060
2063	\$235,522	\$233,418	\$235,398
2064	\$231,914	\$229,842	\$231,792
2065	\$228,361	\$226,321	\$228,241
	\$36,854,509	\$34,899,304	\$35,258,955

TOTAL:	Options		
	1a	1b	1c
	\$33,308,422	\$31,809,956	\$32,627,616
SCORE:	3	3	3

Scoring:

- 1 More than \$50 million
- 2 \$40 to \$50 million
- 3 \$30 to \$40 million
- 4 \$20 to \$30 million
- 5 Less than \$20 million

EN-10 Non-renewable Resource Generated

Revenue generated from struvite and biosolids production

Struvite Production:	Options		
	1a	1b	1c
Saanich:	-	-	-
Clover:	-	-	-
McLoughlin/Macaulay:	200	-	-
West Shore:	50	250	250
TOTAL:	250	250	250

Biosolids for Cement Kiln:	Options		
	1a	1b	1c
Saanich:	-	-	-
Clover:	-	-	-
McLoughlin/Macaulay:	1,106	-	-
West Shore:	277	1382	1382
TOTAL:	1,383	1,382	1,382

Biosolids for Soil Amendment:	Options		
	1a	1b	1c
Saanich:	-	-	-
Clover:	-	-	-
McLoughlin/Macaulay:	442	-	-
West Shore:	111	553	553
TOTAL:	553	553	553

Biosolids for Willow Coppice:	Options		
	1a	1b	1c
Saanich:	-	-	-
Clover:	-	-	-
McLoughlin/Macaulay:	221	-	-
West Shore:	55	277	277
TOTAL:	276	277	277

Biosolids from Biocell:	Options		
	1a	1b	1c
Saanich:	-	-	-
Clover:	-	-	-
McLoughlin/Macaulay:	442	-	-
West Shore:	111	553	553
TOTAL:	553	553	553

Assumptions:	Value	Reference/Basis
Value for Struvite:	\$1,200 per tonne	
Value for Cement Kiln Biosolids:	\$60 per tonne	
Value for Soil Amendment:	\$114 per tonne	
Value for Coppice Biosolids:	\$123 per tonne	
Value for Biocell Biosolids:	\$0 per tonne	

Total Annual Revenue:	Options		
	1a	1b	1c
Saanich:	-	-	-
Clover:	-	-	-
McLoughlin/Macaulay:	\$384,440	-	-
West Shore:	\$96,127	\$480,607	\$480,607
TOTAL:	\$480,567	\$480,607	\$480,607

2030 loading in 2009 \$

\$893,997	\$894,071	\$894,071
\$430,028	\$430,063	\$430,063

2030 loading inflated to 2030 \$
2030 loading discounted to 2015 \$

NPV Calculation

Year	1a	1b	1c
2015	\$542,088	\$542,133	\$542,133
2016	\$533,783	\$533,827	\$533,827
2017	\$525,605	\$525,649	\$525,649
2018	\$517,553	\$517,596	\$517,596
2019	\$509,624	\$509,667	\$509,667
2020	\$501,817	\$501,859	\$501,859
2021	\$494,129	\$494,170	\$494,170
2022	\$486,559	\$486,599	\$486,599
2023	\$479,105	\$479,145	\$479,145
2024	\$471,765	\$471,804	\$471,804
2025	\$464,538	\$464,576	\$464,576
2026	\$457,421	\$457,459	\$457,459
2027	\$450,413	\$450,451	\$450,451
2028	\$443,513	\$443,550	\$443,550
2029	\$436,718	\$436,755	\$436,755
2030	\$430,028	\$430,063	\$430,063
2031	\$423,440	\$423,475	\$423,475
2032	\$416,953	\$416,987	\$416,987
2033	\$410,565	\$410,599	\$410,599
2034	\$404,275	\$404,309	\$404,309
2035	\$398,082	\$398,115	\$398,115
2036	\$391,983	\$392,015	\$392,015
2037	\$385,978	\$386,010	\$386,010
2038	\$380,065	\$380,096	\$380,096
2039	\$374,242	\$374,273	\$374,273
2040	\$368,509	\$368,539	\$368,539
2041	\$362,863	\$362,893	\$362,893
2042	\$357,304	\$357,334	\$357,334
2043	\$351,830	\$351,859	\$351,859
2044	\$346,440	\$346,469	\$346,469
2045	\$341,133	\$341,161	\$341,161
2046	\$335,906	\$335,934	\$335,934
2047	\$330,760	\$330,788	\$330,788
2048	\$325,693	\$325,720	\$325,720
2049	\$320,703	\$320,730	\$320,730
2050	\$315,790	\$315,817	\$315,817
2051	\$310,952	\$310,978	\$310,978
2052	\$306,189	\$306,214	\$306,214
2053	\$301,498	\$301,523	\$301,523
2054	\$296,879	\$296,904	\$296,904
2055	\$292,331	\$292,355	\$292,355
2056	\$287,852	\$287,876	\$287,876
2057	\$283,442	\$283,466	\$283,466
2058	\$279,100	\$279,123	\$279,123
2059	\$274,824	\$274,847	\$274,847
2060	\$270,614	\$270,636	\$270,636
2061	\$266,468	\$266,490	\$266,490
2062	\$262,386	\$262,408	\$262,408
2063	\$258,366	\$258,387	\$258,387
2064	\$254,408	\$254,429	\$254,429
2065	\$250,510	\$250,531	\$250,531
SUM	\$19,282,990	\$19,284,592	\$19,284,592

TOTAL:	Options		
	1a	1b	1c
\$19,282,990	\$19,284,592	\$19,284,592	\$19,284,592
SCORE: 3	3	3	3

- Scoring:**
- 1 Less than \$5 million
 - 2 \$5 to \$15 million
 - 3 \$15 to \$25 million
 - 4 \$25 to \$35 million
 - 5 More than \$35 million

EN-11 Flexibility for Future Resource Recovery

Additional space needed to add 100% additional resource recovery

<u>Solids Treatment Site Area (hectares):</u>	Options		
	1a	1b	1c
Saanich:	-	-	-
Clover:	-	-	-
McLoughlin/Macaulay:	1.80	-	-
West Shore:	1.43	2.44	2.44
TOTAL:	3.23	2.44	2.44

Assumptions: Value Reference/Basis
 Cost of additional space \$2,000,000
 Expansion Needed to double treatment: 25%
 Assuming 40% of West Shore Site Area is used for solids treatment

Calculation:

Future Regulation Cost = Used Site Area x (1 - percent expansion available) x cost of additional space

	Options		
	1a	1b	1c
Saanich:	-	-	-
Clover:	-	-	-
McLoughlin/Macaulay:	\$900,000	-	-
West Shore:	\$715,000	\$1,220,000	\$1,220,000
TOTAL:	\$1,615,000	\$1,220,000	\$1,220,000
SCORE:	2	3	3

- Scoring:**
- 1 More than \$2.5 million
 - 2 \$2 to \$2.5 million
 - 3 \$1.5 to \$2 million
 - 4 \$1 to \$1.5 million
 - 5 Less than \$1 million

EN-12 Terrestrial and Inter-tidal habitat Impacts

Area of habitat potentially impacted

<i>Sensitive Habitats Impacted</i>	Options		
	1a	1b	1c
Saanich:	none	none	none
Clover:	bluff (1)	bluff (1)	bluff (1)
McLoughlin/Macaulay:	tidal x 2	tidal (1)	tidal (1)
West Shore:	shoreline (1)	shoreline x 2	shoreline x 3
Biosolids Facility:	none	-	-
Total	4	4	5

<i>Cost of habitat impacts</i>	Options		
	1a	1b	1c
Saanich:	\$0	\$0	\$0
Clover:	\$1,000,000	\$1,000,000	\$1,000,000
McLoughlin/Macaulay:	\$2,000,000	\$1,000,000	\$1,000,000
West Shore:	\$1,000,000	\$2,000,000	\$3,000,000
TOTAL:	\$4,000,000	\$4,000,000	\$5,000,000
SCORE:	3	3	2

Scoring:

- 1 More than \$5 million
- 2 \$4 to \$5 million
- 3 \$3 to \$4 million
- 4 \$2 to \$3 million
- 5 Less than \$2 million

Notes:

Assumed a \$1,000,000 mitigation cost per habitat site impacted

SO-01 Impact on Property Values

Perception of lost value to current property owners

<i>Private property within 500 m radius:</i>	Options		
	1a	1b	1c
Saanich:	100	100	100
Clover:	60	60	60
McLoughlin/Macaulay:	0	0	0
West Shore:	0	0	0
TOTAL:	160	160	160
SCORE:	3	3	3

<i>Perceived Property Value Reduction</i>	Options		
	1a	1b	1c
Saanich:	\$500,000	\$500,000	\$500,000
Clover:	\$300,000	\$300,000	\$300,000
McLoughlin/Macaulay:	\$0	\$0	\$0
West Shore:	\$0	\$0	\$0
TOTAL:	\$800,000	\$800,000	\$800,000
SCORE:	3	3	3

Scoring:

- 1 More than \$1.25 million
- 2 \$1 million to \$1.25 million
- 3 \$750,000 to \$1 million
- 4 \$500,000 to \$750,000
- 5 Less than \$500,000

Assumptions:

Value	Reference/basis
Average Home Value	\$500,000 per home
Perceived Value Reduction	1% of home value

Note:

Impact to property values from noise, odour, traffic, and visual impacts are addressed in other criteria.
 Impact on future community is addressed further in another criteria

SO-02 Operations Traffic in Sensitive Areas

Cost of traffic inconvenience during operations

<i>2005 Average Traffic Count</i>	Options		
	1a	1b	1c
Saanich:	4,100	4,100	4,100
Clover:	7,350	7,350	7,350
McLoughlin/Macaulay:	13,150	13,150	13,150
West Shore:	4,950	4,950	4,950
Biosolids Facility:	19,750	-	-
TOTAL:	49,300	29,550	29,550

<i>Operations Trips Per Day</i>	Options		
	1a	1b	1c
Saanich:	7.0	7.0	7.0
Clover:	2.7	2.7	0.8
McLoughlin/Macaulay:	9.2	4.0	1.3
West Shore:	8.3	21.7	24.2
Biosolids:	7.6	-	-
TOTAL:	34.8	35.4	33.3

Scoring:	
1	More than \$18 million
2	\$13 to \$18 million
3	\$8 to \$13 million
4	\$3 to \$8 million
5	Less than \$3 million

<i>Annual Chemical, Labour, and Biosolids Costs</i>	Options		
	1a	1b	1c
Saanich:	\$1,275,600	\$1,275,600	\$1,275,600
Clover:	\$485,700	\$485,700	\$140,000
McLoughlin/Macaulay:	\$1,686,400	\$738,000	\$230,000
West Shore:	\$1,521,300	\$3,966,500	\$4,424,400
Biosolids Facility:	\$1,390,000	-	-
TOTAL:	\$6,359,000	\$6,465,800	\$6,070,000

<i>Operations Traffic NPV Cost</i>	Options		
	1a	1b	1c
Saanich:	\$1,647,437	\$1,647,437	\$1,647,437
Clover:	\$1,124,517	\$1,124,517	\$324,135
McLoughlin/Macaulay:	\$6,985,490	\$3,056,981	\$952,718
West Shore:	\$2,372,087	\$6,184,765	\$6,898,746
Biosolids:	\$8,647,538	-	-
TOTAL:	\$20,777,069	\$12,013,700	\$9,823,036
SCORE:	1	3	3

Assumptions:

- One operations trip per \$500 spent on O&M
- One existing trip impacted by one operations trip costs \$0.50
- Probability of existing traffic impacted by operations is 1%
- Assumed NPV factor of 31.5

SO-03 Operations Noise in Sensitive Areas

Population impacted by noise

<u>Existing Property within 500 m of site</u>	Options		
	1a	1b	1c
Saanich:	100	100	100
Clover:	60	60	60
McLoughlin/Macaulay:	0	0	0
West Shore:	0	0	0
TOTAL:	160	160	160
SCORE:	3	3	3

<u>Assumptions:</u>	Value	Reference/basis
Average Home Value	\$500,000	per home
Cost of noise	1%	of home value

<u>Cost of Noise</u>	Options		
	1a	1b	1c
Saanich:	\$500,000	\$500,000	\$500,000
Clover:	\$300,000	\$300,000	\$300,000
McLoughlin/Macaulay:	\$0	\$0	\$0
West Shore:	\$0	\$0	\$0
TOTAL:	\$800,000	\$800,000	\$800,000
SCORE:	3	3	3

Scoring:

- 1 More than \$1.25 million
- 2 \$1 million to \$1.25 million
- 3 \$750,000 to \$1 million
- 4 \$500,000 to \$750,000
- 5 Less than \$500,000

SO-04 Odour Potential

Population impacted by odour

	Options		
	1a	1b	1c
<u>Private Property within 500 m of site</u>			
Saanich:	100	100	100
Clover:	60	60	60
McLoughlin/Macaulay:	0	0	0
West Shore:	0	0	0
Biosolids:	0	-	-
TOTAL:	160	160	160

	Options		
	1a	1b	1c
<u>Other Residential Equivalents within 500 m</u>			
Saanich:	50	50	50
Clover:	0	0	0
McLoughlin/Macaulay:	40	40	0
West Shore:	0	0	0
Biosolids:	200	-	-
TOTAL:	290	90	50

Assumptions: Value Reference/basis
 Average Home Value \$500,000 per residential equivalent
 Cost of odour 25% of home value
 Assuming odour is bad enough, the usability of the property is impacted

	Options		
	1a	1b	1c
<u>Cost of Odour</u>			
Saanich:	\$18,750,000	\$18,750,000	\$18,750,000
Clover:	\$7,500,000	\$7,500,000	\$7,500,000
McLoughlin/Macaulay:	\$5,000,000	\$5,000,000	\$0
West Shore:	\$0	\$0	\$0
Biosolids:	\$25,000,000	-	-
TOTAL:	\$56,250,000	\$31,250,000	\$26,250,000
SCORE:	2	4	4

- Scoring:**
- 1 More than \$60 million
 - 2 \$55 million to \$60 million
 - 3 \$40 to \$55 million
 - 4 \$25 to \$40 million
 - 5 Less than \$25 million

SO-05 Visual Impacts

Loss of open water or territorial view

<i>Current properties within 500 m</i>	Options		
	1a	1b	1c
Saanich:	100	100	100
Clover:	60	60	60
McLoughlin/Macaulay:	0	0	0
West Shore:	0	0	0
TOTAL:	160	160	160

<i>Cost of Lost View</i>	Options		
	1a	1b	1c
Saanich:	\$1,000,000	\$1,000,000	\$1,000,000
Clover:	\$600,000	\$600,000	\$600,000
McLoughlin/Macaulay:	\$0	\$0	\$0
West Shore:	\$0	\$0	\$0
TOTAL:	\$1,600,000	\$1,600,000	\$1,600,000
SCORE:	3	3	3

Scoring:	
1	More than \$2.5 million
2	\$2 to \$2.5 million
3	\$1.5 to \$2 million
4	\$1 to \$1.5 million
5	Less than \$1 million

Assumptions: Value Reference/basis
 Average Home Value \$500,000 per residential equivalent
 Value of a View 2% of home value

McLoughlin and Biosolids Facility will be sited on current industrial sites and not impact views

SO-06 Construction Disruption

Cost of traffic inconvenience due to construction

<u>2005 Estimated Traffic Count</u>	Options		
	1a	1b	1c
Saanich:	4,100	4,100	4,100
Clover:	7,350	7,350	7,350
McLoughlin/Macaulay:	13,150	13,150	13,150
West Shore:	4,950	4,950	4,950
Biosolids Facility:	19,750	-	-
TOTAL:	49,300	29,550	29,550

<u>Estimated Construction Cost</u>	Options		
	1a	1b	1c
Saanich:	\$146,555,300	\$146,555,300	\$146,555,300
Clover:	\$68,457,400	\$68,457,400	\$49,167,300
McLoughlin/Macaulay:	\$324,952,300	\$135,059,900	\$121,375,000
West Shore:	\$241,157,100	\$524,918,900	\$568,497,000
Biosolids Facility:	\$183,788,700	-	-
TOTAL:	\$964,910,800	\$874,991,500	\$885,594,600

<u>Kilometers of Pipeline</u>	Options		
	1a	1b	1c
Clover to McLoughlin/Macaulay	3.3	3.3	3.3
McLoughlin to Biosolids	3.2	-	-
Macaulay to West Shore	-	2.6	2.6
TOTAL:	6.5	5.9	5.9

<u>Pipeline Disruption Factor</u>	Options		
	1a	1b	1c
Clover to McLoughlin	0.5	0.5	1.0
McLoughlin to Biosolids	1.5	-	-
Macaulay to West Shore	-	0.5	1.00

Notes:

- Assumed a 3 year construction schedule for plant
- Assumed an 8 month construction schedule for conveyance
- One construction trip per \$2500 spent on construction
- One existing trip impacted by one construction trip costs \$1
- One existing trip impacted by conveyance construction costs \$2
- Probability of existing traffic impacted by plant construction is 1%
- Probability of existing traffic impacted by pipeline construction is 50%
- McLoughlin to Biosolids is 1.5 due to heavy existing utilities, etc.
- McLoughlin to West Shore is 0.75 for 1c due to larger tunnel/pipeline

Plant Trips = Cost / 2,500 / (3 x 365)

<u>Plant Construction Trips Per Day</u>	Options		
	1a	1b	1c
Saanich:	54	54	54
Clover:	25	25	18
McLoughlin/Macaulay:	119	49	44
West Shore:	88	192	208
Biosolids:	67	-	-
TOTAL:	352	320	324

Scoring:

- 1 More than \$40 million
- 2 \$30 to \$40 million
- 3 \$20 to \$30 million
- 4 \$10 to \$20 million
- 5 Less than \$10 million

Plant Cost = Plant Trips x 1% x \$1 x Traffic Count x 3 x 365

<u>Plant Construction Traffic Cost</u>	Options		
	1a	1b	1c
Saanich:	\$2,403,507	\$2,403,507	\$2,403,507
Clover:	\$2,012,648	\$2,012,648	\$1,445,519
McLoughlin/Macaulay:	\$17,092,491	\$7,104,151	\$6,384,325
West Shore:	\$4,774,911	\$10,393,394	\$11,256,241
Biosolids:	\$14,519,307	-	-
TOTAL:	\$40,802,863	\$21,913,699	\$21,489,591

Conveyance Cost = Length x 50% x \$2 x Traffic Count x 8/12 x 365 x Pipeline Disruption Factor

<u>Cost of Conveyance Traffic</u>	Options		
	1a	1b	1c
Clover to McLoughlin/Macaulay	\$2,951,025	\$2,951,025	\$5,902,050
McLoughlin to Biosolids	\$15,359,200	-	-
Macaulay to West Shore	-	\$1,565,850	\$3,131,700
TOTAL:	\$18,310,225	\$4,516,875	\$9,033,750

Total Cost = Plant Cost + Conveyance Cost

<u>Total Traffic Disruption</u>	Options		
	1a	1b	1c
TOTAL:	\$59,113,088	\$26,430,574	\$30,523,341
SCORE:	1	3	2

SO-07 Public and Stakeholder Acceptability

Lost time due to public disapproval

Construction Delay (Years)	Options		
	1a	1b	1c
Saanich:	1.00	1.00	1.00
Clover:	0.00	0.00	0.00
McLoughlin/Macaulay:	1.00	0.00	0.00
West Shore:	1.00	2.00	2.00
Biosolids:	1.00	-	-

Estimated Construction Cost	Options		
	1a	1b	1c
Saanich:	\$146,555,300	\$146,555,300	\$146,555,300
Clover:	\$68,457,400	\$68,457,400	\$49,167,300
McLoughlin/Macaulay:	\$324,952,300	\$135,059,900	\$121,375,000
West Shore:	\$241,157,100	\$524,918,900	\$568,497,000
Biosolids:	\$183,788,700	-	-
TOTAL:	\$964,910,800	\$874,991,500	\$885,594,600

Assumptions: Value Reference/Basis
 Probability of Delay 25%

2 years for West Shore options 1b and 1c includes impact from liquid, biosolids, and DND (ie conveyance/tunnels issues).

Calculation:

Public Disapproval Cost = probability of delay x [construction cost x (1 + inflation)ⁿ duration of delay - construction cost]

	Options		
	1a	1b	1c
Saanich:	\$1,099,165	\$1,099,165	\$1,099,165
Clover:	\$0	\$0	\$0
McLoughlin/Macaulay:	\$2,437,142	\$0	\$0
West Shore:	\$1,808,678	\$7,991,890	\$8,655,367
Biosolids:	\$1,378,415	-	-
TOTAL:	\$6,723,401	\$9,091,055	\$9,754,532
SCORE:	3	2	2

Scoring:

- 1 More than \$10 million
- 2 \$7 to \$10 million
- 3 \$4 to \$7 million
- 4 \$1 to \$4 million
- 5 Less than \$1 million

SO-08 Impacts on Future Development

Loss of value of developable land adjacent to plant

<u>Undeveloped land within 2 km of plant site</u>	Options		
	1a	1b	1c
Saanich:	157	157	157
Clover:	31	31	31
McLoughlin/Macaulay:	126	126	126
West Shore:	471	471	471
Biosolids	189	-	-

<u>Percentage of Undeveloped Land Impacted</u>	Options		
	1a	1b	1c
Saanich:	10%	10%	10%
Clover:	5%	5%	2%
McLoughlin/Macaulay:	10%	5%	2%
West Shore:	10%	20%	25%
Biosolids	20%	-	-

Assumptions:

Developable land areas estimated by Bob Dawson

Cost of impact on future development \$200,000 per hectare

West Shore 1c will have larger site which will increase the percentage of area impacted

Calculation:

Lost Development = Area of developable land x Percentage Impacted x Cost of impact on development

	Options		
	1a	1b	1c
Saanich:	\$3,142,500	\$3,142,500	\$3,142,500
Clover:	\$314,250	\$314,250	\$125,700
McLoughlin/Macaulay:	\$2,514,000	\$1,257,000	\$502,800
West Shore:	\$9,427,500	\$18,855,000	\$23,568,750
Biosolids	\$7,542,000	-	-
TOTAL:	\$15,398,250	\$23,568,750	\$27,339,750
SCORE:	3	2	1

Scoring:

1	More than \$25 million
2	\$20 to \$25 million
3	\$15 to \$20 million
4	\$10 to \$15 million
5	Less than \$10 million

SO-09 Loss of Beneficial Site Uses

Loss of higher or better land usage at site (measured using park land)

<i>Area of park or open space lost</i>	Options		
	1a	1b	1c
Saanich:	1.80	1.80	1.80
Clover:	0.50	0.50	0.20
McLoughlin/Macaulay:	3.15	0.50	0.20
West Shore:	3.00	8.00	11.00
TOTAL:	8.45	10.80	13.20

<i>Cost of Lost Park Land</i>	Options		
	1a	1b	1c
Saanich:	\$1,800,000	\$1,800,000	\$1,800,000
Clover:	\$500,000	\$500,000	\$200,000
McLoughlin/Macaulay:	\$3,150,000	\$500,000	\$200,000
West Shore:	\$3,000,000	\$8,000,000	\$11,000,000
TOTAL:	\$8,450,000	\$10,800,000	\$13,200,000
SCORE:	4	3	2

SO-09 Scoring:	
1	More than \$16 million
2	\$13 to \$16 million
3	\$10 to \$13 million
4	\$7 to \$10 million
5	Less than \$7 million

Assumptions: Value Reference/Basis

Incremental value of park over WWTP \$1,000,000 per hectare

McLoughlin is 1.35 hectares

BC Hydro Site (Biosolids) is 1.8 hectares

SO-10 Compatibility with Designated Land Use

Delay due to zoning incompatibility issues

<u>Zoning of current site:</u>	Options		
	1a	1b	1c
Saanich:	Institutional	Institutional	Institutional
Clover:	Park	Park	Park
McLoughlin/Macaulay:	Industrial	Industrial	Industrial
West Shore:	Industrial	Industrial	Industrial

<u>Construction cost:</u>	Options		
	1a	1b	1c
Saanich:	\$146,555,300	\$146,555,300	\$146,555,300
Clover:	\$68,457,400	\$68,457,400	\$49,167,300
McLoughlin/Macaulay:	\$508,741,000	\$135,059,900	\$121,375,000
West Shore:	\$241,157,100	\$524,918,900	\$568,497,000
Total:	\$964,910,800	\$874,991,500	\$885,594,600

<u>Assumptions:</u>	Value	Reference/Basis
delay due to rezoning:	0.50	years

Calculation:

Rezoning Cost = construction cost x (1 + inflation)ⁿ duration of delay

	Options		
	1a	1b	1c
Saanich:	\$2,182,085	\$2,182,085	\$2,182,085
Clover:	\$1,019,273	\$1,019,273	\$732,060
McLoughlin/Macaulay:	\$7,574,724	\$2,010,928	\$1,807,171
West Shore:	\$3,590,626	\$7,815,600	\$8,464,441
TOTAL:	\$14,366,708	\$13,027,885	\$13,185,757
SCORE:	3	3	3

Scoring:

- 1 More than \$20 million
- 2 \$15 to \$20 million
- 3 \$10 to \$15 million
- 4 \$5 to \$10 million
- 5 Less than \$5 million

SO-11 Cultural Resource Impacts

Risk cost of a cultural site find

<i>Delay caused by cultural find</i>	Options		
	1a	1b	1c
Saanich:	1.0	1.0	1.0
Clover:	1.0	1.0	1.0
McLoughlin/Macaulay:	1.0	1.0	1.0
West Shore:	1.0	1.0	1.0

<i>Estimated construction cost</i>	Options		
	1a	1b	1c
Saanich:	\$146,555,300	\$146,555,300	\$146,555,300
Clover:	\$68,457,400	\$68,457,400	\$49,167,300
McLoughlin/Macaulay:	\$508,741,000	\$135,059,900	\$121,375,000
West Shore:	\$241,157,100	\$524,918,900	\$568,497,000
TOTAL:	\$964,910,800	\$874,991,500	\$885,594,600

<i>Probability of a cultural find</i>	Options		
	1a	1b	1c
Saanich:	5%	5%	5%
Clover:	5%	5%	5%
McLoughlin/Macaulay:	5%	20%	20%
West Shore:	5%	5%	5%

Notes:

Risk of cultural find from trunk sewer installation accounts for increase for options 1b and 1c

Calculation:

Cultural Resources Impact = probability of a cultural find x construction cost x (1 + inflation)ⁿ duration of delay

	Options		
	1a	1b	1c
Saanich:	\$219,833	\$219,833	\$219,833
Clover:	\$102,686	\$102,686	\$73,751
McLoughlin/Macaulay:	\$763,112	\$810,359	\$728,250
West Shore:	\$361,736	\$767,378	\$852,746
TOTAL:	\$1,447,366	\$1,920,257	\$1,874,579
SCORE:	3	2	2

SO-11 Scoring:	
1	More than \$2 million
2	\$1.5 to \$2 million
3	\$1 to \$1.5 million
4	\$500,000 to \$1 million
5	Less than \$500,000

Resource Recovery Revenues

Annual revenues generated from sale of recovered resources

<i>Heat Recovered:</i>	Options		
	1a	1b	1c
Saanich:	\$443,500	\$443,500	\$443,500
Clover:	\$0	\$0	\$0
McLoughlin/Macaulay:	\$2,176,280	\$0	\$0
West Shore:	\$622,180	\$2,310,600	\$2,310,600
TOTAL:	\$3,241,960	\$2,754,100	\$2,754,100

<i>Water Reuse:</i>	Options		
	1a	1b	1c
Saanich:	\$302,400	\$302,400	\$302,400
Clover:	\$0	\$0	\$0
McLoughlin/Macaulay:	\$259,200	\$0	\$0
West Shore:	\$295,200	\$295,200	\$295,200
TOTAL:	\$856,800	\$597,600	\$597,600

<i>Struvite:</i>	Options		
	1a	1b	1c
Saanich:	\$0	\$0	\$0
Clover:	\$0	\$0	\$0
McLoughlin/Macaulay:	\$240,000	\$0	\$0
West Shore:	\$60,000	\$300,000	\$300,000
TOTAL:	\$300,000	\$300,000	\$300,000

<i>Biosolids for Cement Kiln:</i>	Options		
	1a	1b	1c
Saanich:	\$0	\$0	\$0
Clover:	\$0	\$0	\$0
McLoughlin/Macaulay:	\$66,891	\$0	\$0
West Shore:	\$16,723	\$83,583	\$83,583
TOTAL:	\$83,614	\$83,583	\$83,583

<i>Biosolids for Land Application:</i>	Options		
	1a	1b	1c
Saanich:	\$0	\$0	\$0
Clover:	\$0	\$0	\$0
McLoughlin/Macaulay:	\$50,476	\$0	\$0
West Shore:	\$12,631	\$63,153	\$63,153
TOTAL:	\$63,107	\$63,153	\$63,153

<i>Willow Coppice:</i>	Options		
	1a	1b	1c
Saanich:	\$0	\$0	\$0
Clover:	\$0	\$0	\$0
McLoughlin/Macaulay:	\$27,073	\$0	\$0
West Shore:	\$6,774	\$33,871	\$33,871
TOTAL:	\$33,847	\$33,871	\$33,871

<i>Codigestion Substrate Tipping Fees:</i>	Options		
	1a	1b	1c
Saanich:	\$0	\$0	\$0
Clover:	\$0	\$0	\$0
McLoughlin/Macaulay:	\$705,180	\$0	\$0
West Shore:	\$176,295	\$881,475	\$881,475
TOTAL:	\$881,475	\$881,475	\$881,475

<i>Biomethane</i>	Options		
	1a	1b	1c
Saanich:	\$0	\$0	\$0
Clover:	\$0	\$0	\$0
McLoughlin/Macaulay:	\$985,900	\$0	\$0
West Shore:	\$246,470	\$1,232,370	\$1,232,370
TOTAL:	\$1,232,370	\$1,232,370	\$1,232,370

<i>Other:</i>	Options		
	1a	1b	1c
Saanich:	\$0	\$0	\$0
Clover:	\$0	\$0	\$0
McLoughlin/Macaulay:	\$0	\$0	\$0
West Shore:	\$0	\$0	\$0
TOTAL:	\$0	\$0	\$0

<i>Total Revenue:</i>	Options		
	1a	1b	1c
Saanich:	\$745,900	\$745,900	\$745,900
Clover:	\$0	\$0	\$0
McLoughlin/Macaulay:	\$4,511,000	\$0	\$0
West Shore:	\$1,436,272	\$5,200,252	\$5,200,252
TOTAL:	\$6,693,172	\$5,946,152	\$5,946,152

Notes:

2030 loading in 2009 \$

	\$12,451,272	\$11,061,595	\$11,061,595	2030 loading inflated to 2030 \$
	\$5,989,275	\$5,320,816	\$5,320,816	2030 Loading discounted to 2015 \$

NPV Calculation

Year	1a	1b	1c
2015	\$7,550,009	\$6,707,358	\$6,707,358
2016	\$7,434,343	\$6,604,601	\$6,604,601
2017	\$7,320,449	\$6,503,419	\$6,503,419
2018	\$7,208,300	\$6,403,787	\$6,403,787
2019	\$7,097,869	\$6,305,681	\$6,305,681
2020	\$6,989,129	\$6,209,078	\$6,209,078
2021	\$6,882,056	\$6,113,954	\$6,113,954
2022	\$6,776,623	\$6,020,289	\$6,020,289
2023	\$6,672,805	\$5,928,058	\$5,928,058
2024	\$6,570,577	\$5,837,240	\$5,837,240
2025	\$6,469,916	\$5,747,814	\$5,747,814
2026	\$6,370,797	\$5,659,757	\$5,659,757
2027	\$6,273,196	\$5,573,050	\$5,573,050
2028	\$6,177,091	\$5,487,670	\$5,487,670
2029	\$6,082,458	\$5,403,599	\$5,403,599
2030	\$5,989,275	\$5,320,816	\$5,320,816
2031	\$5,897,519	\$5,239,301	\$5,239,301
2032	\$5,807,169	\$5,159,035	\$5,159,035
2033	\$5,718,203	\$5,079,999	\$5,079,999
2034	\$5,630,600	\$5,002,173	\$5,002,173
2035	\$5,544,340	\$4,925,540	\$4,925,540
2036	\$5,459,400	\$4,850,081	\$4,850,081
2037	\$5,375,762	\$4,775,777	\$4,775,777
2038	\$5,293,406	\$4,702,612	\$4,702,612
2039	\$5,212,311	\$4,630,568	\$4,630,568
2040	\$5,132,458	\$4,559,628	\$4,559,628
2041	\$5,053,829	\$4,489,775	\$4,489,775
2042	\$4,976,404	\$4,420,991	\$4,420,991
2043	\$4,900,166	\$4,353,262	\$4,353,262
2044	\$4,825,095	\$4,286,570	\$4,286,570
2045	\$4,751,175	\$4,220,899	\$4,220,899
2046	\$4,678,387	\$4,156,235	\$4,156,235
2047	\$4,606,714	\$4,092,562	\$4,092,562
2048	\$4,536,139	\$4,029,864	\$4,029,864
2049	\$4,466,645	\$3,968,126	\$3,968,126
2050	\$4,398,216	\$3,907,335	\$3,907,335
2051	\$4,330,836	\$3,847,474	\$3,847,474
2052	\$4,264,487	\$3,788,531	\$3,788,531
2053	\$4,199,155	\$3,730,491	\$3,730,491
2054	\$4,134,824	\$3,673,339	\$3,673,339
2055	\$4,071,479	\$3,617,064	\$3,617,064
2056	\$4,009,104	\$3,561,650	\$3,561,650
2057	\$3,947,684	\$3,507,086	\$3,507,086
2058	\$3,887,206	\$3,453,357	\$3,453,357
2059	\$3,827,654	\$3,400,452	\$3,400,452
2060	\$3,769,014	\$3,348,357	\$3,348,357
2061	\$3,711,273	\$3,297,060	\$3,297,060
2062	\$3,654,416	\$3,246,549	\$3,246,549
2063	\$3,598,430	\$3,196,812	\$3,196,812
2064	\$3,543,302	\$3,147,837	\$3,147,837
2065	\$3,489,019	\$3,099,612	\$3,099,612
TOTAL:	\$268,566,711	\$238,592,177	\$238,592,177