

Capital Regional District

Core Area Wastewater Treatment Program Biosolids Management Plan

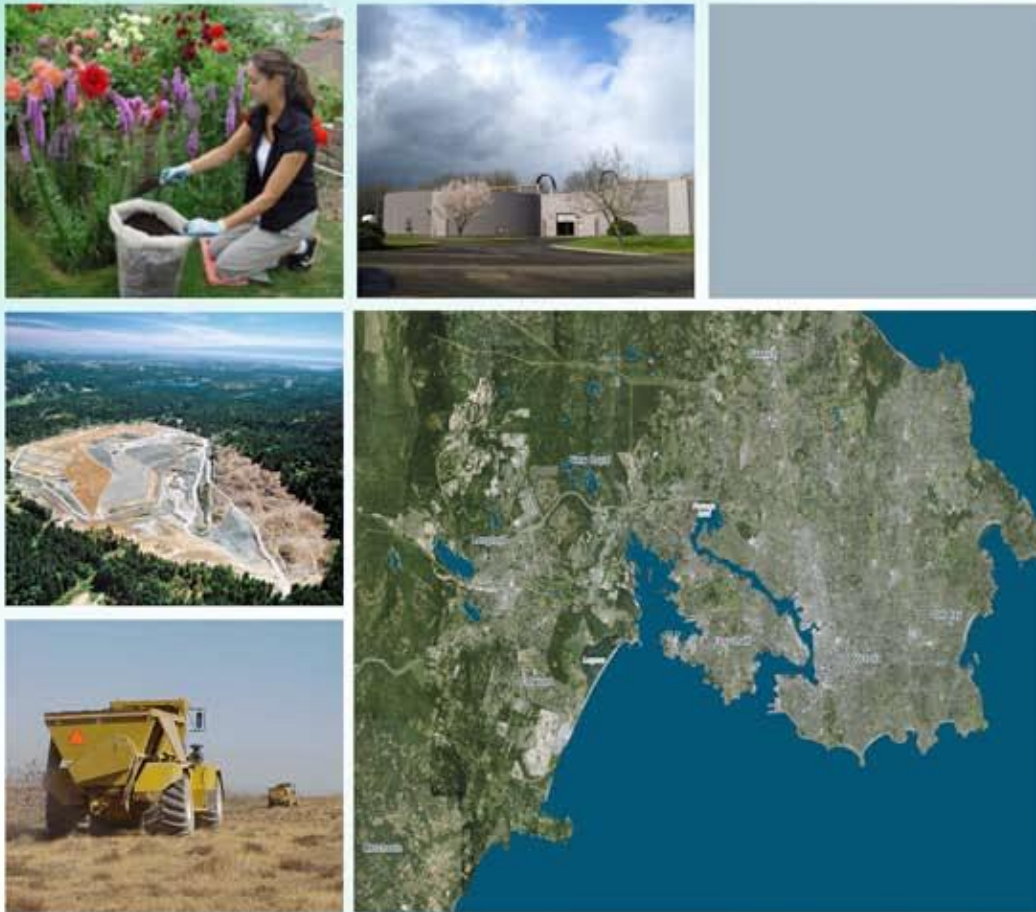

Prepared by:
Stantec Consulting Ltd. | Brown and Caldwell



November 4, 2009

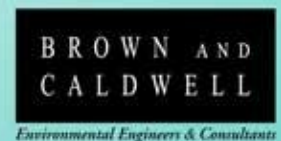

Capital Regional District

Core Area Wastewater Treatment Program

Biosolids Management Plan

November 2009

Prepared by:

Stantec Consulting Ltd.



Stantec

Brown and Caldwell

BROWN AND
CALDWELL

This report was prepared by Stantec Consulting Ltd. | Brown and Caldwell for the Capital Regional District. The material in it reflects our best judgment in light of the information available to us at the time of preparation. Any use which a third party makes of this report, or any release of or decisions made based on it, are the responsibilities of such third parties. Stantec Consulting Ltd. | Brown and Caldwell accepts no responsibility for damages, if any, suffered by any third party as a result of decisions made or actions taken based on this report.

List of Abbreviations

Abbreviation	Definition
ADWF	average dry weather flow
BAF	biological aerated filter
BCEAA	BC Environmental Assessment Act
BEAM	Biosolids Emissions Assessment Model
BGM	biosolids growing medium
BMP	Biosolids Management Plan
BOD ₅	biochemical oxygen demand
CALWMC	Core Area Liquid Waste Management Committee
CAS	conventional activated sludge
CAWTP	Core Area Wastewater Treatment Program
CCME	Canadian Council of Ministers of the Environment
CEA	Consulting Engineers of Alberta
CEP	chemically enhanced primaries
CHP	combined heat and power
CEP	chemically enhanced primaries
CEPA	Canadian Environmental Protection Act
CH ₄	methane
CHP	combined heat and power
CNG	compressed natural gas
CO ₂	carbon dioxide
COP	coefficient of performance
CRD	Capital Regional District
CVRD	Cowichan Valley Regional District
DLD	dedicated land disposal
DT	dry tonne
dw	dry weight
EA	environmental assessment
EIA	Energy Information Administration

CAPITAL REGIONAL DISTRICT

Core Area Wastewater Treatment Program
Biosolids Management Plan

Abbreviation	Definition
EMA	Environmental Management Act
EPA	U.S. Environmental Protection Agency
EQ	exceptional quality
ESP	electro-filter
FBC	fluidized bed combustion
FBI	fluidized bed incinerator
FOG	fats, oils, and grease
GHG	greenhouse gas
GWP	global warming potential
H ₂ S	hydrogen sulphide
ha	hectare
HFCs	hydrofluorocarbons
HRT	hydraulic retention time
IC	internal combustion
IFAS	integrated fixed-film activated sludge
LBC	landfill biocell
LMOP	Landfill Methane Outreach Program
MABC	Mining Association of British Columbia
MBBR	moving bed bioreactors
MBR	membrane bioreactor
MCES	Metropolitan Council Environmental Services
MFR	manufacturer
MHF	multiple hearth furnace
MPN	most probable number
MSW	municipal solids waste
N ₂ O	nitrous oxide
NAAQO	National Ambient Air Quality Objective
NOAMI	National Orphaned/Abandoned Mines Initiative
NO _x	nitrogen oxide
NPRI	National Pollutant Release Inventory
NPV	net present value

CAPITAL REGIONAL DISTRICT

Core Area Wastewater Treatment Program
Biosolids Management Plan

Abbreviation	Definition
O&M	operations and maintenance
OACWA	Oregon Association of Clean Water Agencies
OMRR	Organic Matter Recycling Regulation
PFCs	perfluorocarbons
PSCS	Provincial Contaminated Sites Committee
PSA	pressure swing adsorption?
psig	pounds per square inch gauge
R&R	replacement and refurbishment
RDN	Regional District of Nanaimo
SF ₆	sulphur hexafluoride
SRT	solids retention time
SRWC	short rotation woody crops
TBL	triple bottom line
TF/SC	trickling filter/solids contact
TPAD	temperature-phased anaerobic digestion
tpy	tonnes per year
tpd	tonnes per day
TS	total solids
TSS	total suspended solids
UV	ultraviolet
VF	volatile fraction
VOC	volatile organic compound
VS	volatile solids
VSr	volatile solids reduction
WAS	waste activated sludge
WTE	waste-to-energy
WWTP	wastewater treatment plant

Table of Contents

Section 1 Introduction

Section 2 Biosolids Management Objectives

2.1	LIQUID STREAM TREATMENT: SERVICE REGION, FLOWS, AND OVERVIEW OF PROCESSES	2-1
2.2	SLUDGE FLOWS AND LOADS	2-2
2.3	SOLIDS TREATMENT: OVERALL OBJECTIVES	2-4
2.3.1	Support of Ultimate Utilization/Disposal	2-5
2.3.2	Implementation on Required Schedule	2-5
2.3.3	Resource Recovery	2-5
2.3.4	Reduction of Greenhouse Gas Emissions	2-5
2.3.5	Integration with Solid Waste Management.....	2-6
2.3.6	End Use Reliability: Primary and Backup Alternatives.....	2-6
2.3.7	Process Reliability: Proven Technology.....	2-7
2.4	REGULATORY REQUIREMENTS	2-8
2.4.1	Trace Metals.....	2-8
2.4.2	Emerging Contaminants.....	2-9
2.4.3	Pathogens	2-9
2.4.4	Air Emissions.....	2-10
2.4.5	Land-Based Programs	2-12
2.5	REFERENCES.....	2-14

Section 3 Biosolids Beneficial Use and Disposal Alternatives

3.1	FERTILIZER AND SOIL AMENDMENT ALTERNATIVES	3-2
3.1.1	Regulatory Requirements.....	3-3
3.1.2	Distribution	3-3
3.1.3	Sampling and Monitoring Requirements	3-4
3.1.4	Fertilizer Product: Anaerobically Digested and Thermally Dried Biosolids	3-4
3.1.5	Topsoil Blending Without Thermal Drying.....	3-5
	(Class A anaerobically digested dried product mixed with sand and wood waste)	3-5
3.1.6	Mine Reclamation.....	3-7
3.1.7	Land Application of Biosolids for Agriculture.....	3-9
3.1.8	Class A Lime-Pasteurized Fertilizer	3-11
3.1.9	Composting	3-13
3.1.10	Fertilizer and Soil Amendment Summary.....	3-15
3.2	ENERGY PRODUCTION ALTERNATIVES.....	3-16
3.2.1	Biomass Production (Willow Coppice)	3-16
3.2.2	<i>Biocells</i>	3-20
3.2.3	Biosolids For Fuel: Cement Kiln	3-23
3.2.4	Biosolids For Fuel: Waste-to-Energy	3-24
3.2.5	Thermal Processing to Produce Marketable Fuel	3-33
3.2.6	Comparison of Processes	3-40

CAPITAL REGIONAL DISTRICT

Core Area Wastewater Treatment Program
Biosolids Management Plan

3.3 BACKUP DISPOSAL ALTERNATIVES 3-41

 3.3.1 Landfilling 3-42

 3.3.2 Waste-to-Energy 3-43

 3.3.3 Incineration 3-43

 3.3.4 Dedicated Land Utilization..... 3-43

 3.3.5 Dedicated Land Disposal (DLD)..... 3-44

3.4 PASS/FAIL CRITERIA AND SELECTION OF CANDIDATE ALTERNATIVES 3-44

 3.4.1 Biosolids Management Objectives and Pass/Fail Criteria 3-44

 3.4.2 Backup Alternative Screening 3-45

 3.4.3 Primary Alternative Screening..... 3-46

3.5 REFERENCES..... 3-47

Section 4 Biosolids and Municipal Solid Waste Integration Options

4.1 CO-LANDFILLING WITH ORGANIC SOLID WASTE IN A HARTLAND LANDFILL
 BIOCELL(S) TO ENHANCE GAS PRODUCTION..... 4-1

4.2 CO-DIGESTION WITH FOG, SOURCE SEPARATED FOOD WASTE, OR OTHER FOOD
 PRODUCTION WASTE PRODUCTS 4-2

4.3 CO-COMPOSTING WITH YARD AND FOOD WASTE TO PRODUCE SOIL AMENDMENT
 PRODUCT FOR DISTRIBUTION..... 4-6

4.4 WASTE-TO-ENERGY FACILITY WITH BIOSOLIDS AND SOLID WASTE 4-6

4.5 BIOSOLIDS FACILITY SITING CONSIDERATIONS..... 4-10

4.6 INTEGRATION ALTERNATIVES SCREENING 4-11

4.7 REFERENCES..... 4-12

Section 5 Biosolids Processing Components and Alternatives

5.1 THICKENING 5-1

5.2 SOLIDS STABILIZATION..... 5-2

 5.2.1 Mesophilic Digestion 5-3

 5.2.2 Thermophilic Digestion..... 5-3

 5.2.3 Series Digestion 5-4

 5.2.4 Temperature-Phased Anaerobic Digestion (TPAD)..... 5-5

 5.2.5 Acid/Gas Digestion..... 5-5

5.3 DEWATERING 5-6

 5.3.1 Belt Filter Press 5-6

 5.3.2 High-Speed Centrifuge..... 5-6

 5.3.3 Screw Press 5-7

 5.3.4 Rotary Press..... 5-7

5.4 THERMAL DRYING AND HIGH-TEMPERATURE HEAT PUMPS 5-8

5.5 WASTE-TO-ENERGY EQUIPMENT 5-12

5.6 BIOSOLIDS PROCESSING RECOMMENDATIONS 5-13

CAPITAL REGIONAL DISTRICT

Core Area Wastewater Treatment Program

Biosolids Management Plan

Section 6 Biogas Utilization

6.1	INTRODUCTION.....	6-1
6.1.1	Biogas Production	6-1
6.2	COGENERATION TECHNOLOGY	6-3
6.2.1	Biogas Upgrading to Biomethane	6-5
6.2.2	Biogas Upgrading for Pipeline Injection	6-5
6.2.3	Option 1: Utilizing Tail Gas Heat	6-8
6.2.4	Option 2: Biogas Upgrading for Vehicle Use	6-9
6.3	ALTERNATIVE SCREENING	6-10
6.4	REFERENCES.....	6-11

Section 7 Comprehensive and Integrated Biosolids/Solid Waste Processing and Siting Alternatives

7.1	BIOSOLIDS UTILIZATION OPTIONS.....	7-1
7.1.1	Primary Solids Management Alternatives	7-2
7.1.2	Backup Solids Management Option.....	7-2
7.2	DIGESTION AND DRYING - GENERAL PROCESS DESCRIPTION	7-3
7.3	DIGESTION AND DRYING: PROCESS DESIGN CRITERIA	7-4
7.4	DIGESTION AND DRYING: FACILITY LAYOUTS	7-8
7.5	WTE FACILITY FOR BIOSOLIDS AT THE WWTP SITE	7-9
7.6	WTE FACILITY FOR BIOSOLIDS AND MSW AT HARTLAND LANDFILL SITE.....	7-11
7.7	WTE ALTERNATIVE LAYOUT MODIFICATIONS.....	7-14
7.8	CONSIDERATION OF PHASING OF WTE FACILITIES.....	7-14
7.9	CONSIDERATION OF PHASING OF BIOSOLDS HANDLING FOR EAST SAANICH PLANT	7-14
7.10	CONSIDERATION OF INTEGRATION WITH SAANICH PENINSULA AND SOOKE WASTEWATER TREATMENT PLANTS	7-15
7.11	CONSIDERATION OF ALTERNATIVE OPTIMIZATION AND REFINEMENTS	7-15

Section 8 Carbon Footprint Analysis

8.1	PURPOSE OF ANALYSIS	8-1
8.2	BASIS OF METHODOLOGY	8-2
8.3	ASSUMPTIONS	8-7
8.4	GREENHOUSE GAS CREDITS	8-8
8.5	CARBON FOOTPRINT RESULTS	8-9
8.6	REFERENCES.....	8-11

CAPITAL REGIONAL DISTRICT

Core Area Wastewater Treatment Program
Biosolids Management Plan

Section 9 Economic Evaluation

9.1	BASIS OF COST ESTIMATE.....	9-1
9.1.1	Biosolids Treatment Facility Alternatives	9-1
9.1.2	Biosolids Utilization Options	9-2
9.1.3	Direct Costs	9-2
9.1.4	Indirect Costs	9-2
9.1.5	Financing Costs.....	9-2
9.2	CAPITAL COSTS	9-3
9.2.1	Biosolids Treatment Facility Capital Costs	9-4
9.2.2	Biosolids Utilization Capital Costs	9-4
9.3	OPERATIONS AND MAINTENANCE (O&M) COSTS.....	9-4
9.3.1	Biosolids Treatment Facility O&M Costs	9-4
9.3.2	Biosolids Utilization Operations and Maintenance Costs.....	9-9
9.4	POTENTIAL REVENUES.....	9-10
9.5	NET PRESENT VALUE ANALYSIS.....	9-13
9.6	REFERENCES.....	9-15

Section 10 Risk Assessment

10.1	METHODOLOGY	10-1
10.2	RISK MATRIX	10-2
10.3	RISK RANKING.....	10-3
10.3.1	Site-Specific Risks.....	10-3
10.3.2	Process-Specific Risks.....	10-6
10.3.3	End-Use-Specific Risks.....	10-10

Section 11 Triple Bottom Line Analysis

11.1	TRIPLE BOTTOM LINE METHODOLOGY	11-1
11.2	PLACING VALUE ON FACTORS	11-3
11.2.1	Economic Criteria	11-3
11.2.2	Environmental Impacts.....	11-6
11.2.3	Social Impacts	11-11
11.3	ALTERNATIVE EVALUATION.....	11-15
11.4	REFERENCES.....	11-19

Section 12 Findings and Recommendations

12.1	CONCLUSIONS	12-2
12.2	RECOMMENDATIONS.....	12-3

Section 1 Introduction

The Capital Regional District (CRD) is planning the construction of secondary wastewater treatment plants (WWTPs) to serve the Core Area of Greater Victoria. The Provincial Ministry of Environment has requested that secondary treatment be in place by 2016 and that the CRD submit its Liquid Waste Management Plan Amendment by the end of 2009. More recently (August 2009) the Federal Minister of the Environment has announced stricter National Canadian Council of Ministers of the Environment (CCME) wastewater treatment regulations which will require all communities to have wastewater treatment. These regulations are expected to become law by the end of 2009. To facilitate this schedule, a preferred wastewater treatment strategy must be selected soon.

This CRD project, known as the Core Area Wastewater Treatment Program (CAWTP), has been in the planning stages for several years. A number of options, from decentralized multi-plant treatment to regional WWTP schemes, have been investigated. Resource recovery has also been investigated. A significant amount of work was completed on assessing three options, referred to as Options 1, 2, and 3 in previous work. These options varied in terms of the number of plants (4 for Option 1, 7 for Option 2, and 11 for Option 3) and the degree of resource recovery. Some preliminary work was completed on biosolids treatment but a biosolids management plan was not part of this preliminary work.

CRD engaged a Peer Review Team to review Options 1, 2, and 3; the team identified three sub-options of Option 1 for further consideration by CRD. Options 2 and 3 were eliminated as they were significantly more costly. The Core Area Liquid Waste Management Committee requested that the three options put forward by the Peer Review Team, referred to as Options 1A, 1B, and 1C, be investigated further to refine the economic, social, and environmental considerations to enable decision-making through a Triple Bottom Line (TBL) analysis.

A report titled ***Core Area Wastewater Treatment Assessment of Wastewater Treatment Options 1A, 1B and 1C***, prepared for the CRD by Stantec Consulting, Ltd. and Brown and Caldwell (Stantec and Brown and Caldwell, September 16, 2009), evaluated these options. It further discussed a sub-option, Option 1A Prime, which would be similar to Option 1A but would delay construction of West Shore facilities, treating its wastewater flows at a regional facility at McLoughlin Point until growth required its construction. On September 23, 2009, the Core Area Liquid Waste Management Committee (CALWMC) received the report and moved to accept Option 1A Prime as the preferred option. In addition, the committee moved to remove Option 1C from further consideration, retain and continue to further analyze Option 1A, and retain Option 1B as a backup option should site acquisition for 1A be unsuccessful. In October 2009 the CALWMC approved carrying forward with Option 1A for the Federal Grant submission. The continued evaluation of Option 1A will focus on site locations, assessing whether alternative

CAPITAL REGIONAL DISTRICT

Core Area Wastewater Treatment Program Biosolids Management Plan

sites can be located where regional biosolids facilities can be co-located with liquid stream treatment at a single regional site.

The current significant issues surrounding remaining Options 1A, 1A Prime, and 1B are primarily focused on siting the treatment facilities. All options include similar liquid stream wastewater treatment requirements and process solutions. All remaining options will generate biosolids of the same (or nearly the same) volume, characteristics, and quality. Consequently, this Biosolids Management Plan (BMP) focuses on planning for and recommending biosolids processing and ultimate use/disposal, including issues of resource recovery and integration with solid waste handling that are common to all remaining siting alternatives. The final number, size, and location of biosolids facilities will be the subject of separate investigations following the identification of the final siting option and treatment location.

The purpose of this BMP is to review alternatives for biosolids management and identify economic, non-economic, and sustainability factors that support recommendation of the most promising alternative(s). Process technologies will be described along with examples from successful programs elsewhere in Canada and the U.S. as well as Europe. Regulatory requirements will also be explained. In developing the alternatives, flexibility and potential opportunities for phasing of facilities are considered. In addition the opportunities for integration of biosolids and solid waste streams are identified.

A summary of topics covered in this report is as follows:

- Biosolids management objectives
- Beneficial use alternatives
- Integration with solid waste programs
- Process technologies
- Energy recovery
- Comprehensive alternatives
- Carbon footprint analysis
- Economic evaluation
- TBL analysis
- Recommendations

CAPITAL REGIONAL DISTRICT

Core Area Wastewater Treatment Program
Biosolids Management Plan

These topics are discussed in the following report sections below.

- Section 1 Introduction
- Section 2 Biosolids Management Objectives
- Section 3 Biosolids Beneficial Use and Disposal Alternatives
- Section 4 Biosolids and Municipal Solid Waste Integration Options
- Section 5 Biosolids Processing Components and Alternatives
- Section 6 Biogas Utilization
- Section 7 Comprehensive and Integrated Biosolids/Solid Waste Processing and Siting Alternatives
- Section 8 Carbon Footprint Analysis
- Section 9 Economic Evaluation
- Section 10 Risk Assessment
- Section 11 Triple Bottom Line Analysis
- Section 12 Findings and Recommendations

REFERENCES

Stantec Consulting Ltd./Brown and Caldwell, Core Area Wastewater Treatment Assessment of Wastewater Treatment Options 1A, 1B and 1C, September 16, 2009.

Section 2 Biosolids Management Objectives

To develop a successful biosolids management program, certain fundamental technical requirements must be met. In addition, the CRD, through its development of basic principles behind its long-term wastewater management planning process, has defined a number of key program objectives that go beyond basic technical suitability and embrace the sustainable ethic of the region. This report section describes the liquid stream wastewater treatment background for the generation of biosolids, presents the projected biosolids flow and load expected over time for the program, and finally discusses the driving technical and sustainability objectives for biosolids treatment and utilization.

2.1 LIQUID STREAM TREATMENT: SERVICE REGION, FLOWS, AND OVERVIEW OF PROCESSES

To enable comparison of alternative biosolids processing and utilization alternatives, representative liquid stream technologies have been selected for this evaluation. The representative technologies all use proven secondary wastewater treatment processes which will meet the discharge objectives and which have been constructed at numerous other locations in North America and Europe. These technologies could change depending on the procurement process and final siting of facilities.

To meet the new federal CCME standards a biological treatment plant capable of producing an effluent quality (maximum monthly average) of 25/25 mg/L biochemical oxygen demand (BOD₅) and total suspended solids (TSS) will need to be provided for each of the plants serving the CRD for flows and organic loads up to 2 times average dry weather flow (ADWF). This is the anticipated new federal standard for effluent discharge via outfalls to the open marine environment. Such an effluent quality can reliably be met or exceeded by a range of treatment technologies including conventional activated sludge (CAS) systems, fixed film systems such as trickling filter/solids contact (TF/SC) and biological aerated filter (BAF) processes, or hybrid systems which incorporate characteristics of both suspended growth and fixed film processes such as integrated fixed-film activated sludge (IFAS) processes or moving bed bioreactors (MBBR). Membrane bioreactor (MBR) activated sludge systems may also be appropriate because of their small footprint and for sites where a high proportion of the effluent has a high reuse potential.

Raw wastewater entering the plants would first be pretreated by fine screening and grit removal prior to primary settling. These preliminary processes are required to remove larger solids which are unsightly and would cause odour problems during subsequent processing, and inorganic solids which cause excessive wear on mechanical equipment. Organic solids settle out in the primary settling tanks, reducing the TSS load and BOD load to the bioreactors by an average of

approximately 55% and 30%, respectively. Primary sludge is typically thickened to a concentration of about 4% solids and is fed to anaerobic digestion sludge stabilization facilities.

Storm flows up to 4 times ADWF will be passed through the primary settling process capable of producing an effluent with a maximum BOD and TSS of approximately 130 mg/L. To minimize the plant footprint of the primary settling at all of the plants, lamella plate high-rate settling facilities will be utilized and chemical feed systems will be added, which at high flow rates between 2 and 4 times ADWF would allow operation as high-rate chemically enhanced primaries (CEP). Alum at a dosage of about 70 mg/L and polymer at a dosage of about 1 mg/L would be applied during these high flow times.

The clarified primary effluent is then transferred into the secondary treatment system. CAS provides a typical process example of suspended growth bioreactor tanks where soluble and organic constituents biologically degrade in an aerobic environment to produce carbon dioxide (CO₂), water, and new activated sludge cells. The activated sludge in the bioreactors is kept in suspension by the addition of compressed air added from fine bubble diffusers installed at the bottom of the 4- to 5-m-deep tanks. After a hydraulic retention time of about 6 hours, the contents of the bioreactors, called mixed liquor, is introduced to final settling tanks (secondary clarifiers) where the biological solids are separated from the liquid effluent by gravity. The settled sludge is thickened to about 4% solids concentration and then typically fed to anaerobic digesters. During this biological process the liquid effluent concentration is reduced typically to below 10 mg/L BOD and TSS.

Additional details about liquid stream treatment and siting alternatives are provided in the report titled **Core Area Wastewater Treatment Assessment of Wastewater Treatment Options 1A, 1B and 1C**, prepared for the CRD by Stantec Consulting, Ltd., and Brown and Caldwell (Stantec Consulting Ltd./Brown and Caldwell, September 16, 2009). Waste solids from primary and secondary treatment processes are subjected to additional processing to generate a biosolids product. Biosolids process technologies and utilization alternatives are described in subsequent sections of this report.

2.2 SLUDGE FLOWS AND LOADS

In Option 1A, the **McLoughlin Point** site is to be designed to accept the total flows from its own tributary area plus Clover Point design flows that are between 2 and 4 times ADWF. All biosolids from the McLoughlin Point, Clover Point, and Saanich East plants will be treated as required at an appropriate remote site. Siting investigations are on-going. However, for the purposes of this report, this remote biosolids facility is called the Upper Victoria Harbour site. **Table 2.1** shows the expected flows and loads for the biosolids processing site for McLoughlin Point, Clover Point, and Saanich East plants. For additional details on siting options see the report on assessment of Options 1A, 1B, and 1C (Stantec Consulting Ltd./Brown and Caldwell, September 16, 2009).

CAPITAL REGIONAL DISTRICT

Core Area Wastewater Treatment Program
Biosolids Management Plan

**Table 2.1 – Option 1A: Upper Victoria Harbour Biosolids Processing Facility
Design Flows and Loads ¹**

Item	2030				2065			
	Average (kg/day)	Peak 30-Day (kg/day)	Peak 14-Day (kg/day)	Peak Day (kg/day)	Average (kg/day)	Peak 30-Day (kg/day)	Peak 14-Day (kg/day)	Peak Day (kg/day)
Primary solids ²	10,300	12,300	14,400	16,400	10,700	12,800	14,900	17,000
Secondary solids ³	13,200	15,800	18,400	19,200	13,700	16,400	19,200	20,000
Total raw solids ⁴	23,400	28,100	32,800	35,600	24,300	29,200	34,100	37,000
Total raw volatile solids ⁵	19,700	23,600	27,500	29,900	20,400	24,500	28,600	31,100

Notes:

1. Raw solids production (dry weight) from biosolids processing site (Upper Victoria Harbour) for liquid stream treatment plants at McLoughlin Point, Clover Point, and Saanich East.
2. Typical removal efficiencies for primary clarifiers range from 50%–75%, where removal efficiencies will reduce with high flows or low TSS influent concentrations. It is assumed that 50% of the TSS load is removed by the primary clarifiers.
3. Secondary solids are estimated from conversion of BOD to TSS. Typically 20%–40% of the influent BOD is removed in the primary clarifiers, and it is assumed that 20% of the influent BOD is removed in the primary clarifiers. Sludge yields in the secondary treatment system will vary based on the system solids retention time (SRT), and typical yields can range from 0.4 for a 15-day SRT to 1.0 for a 2-day SRT. In addition, removal efficiencies of the secondary clarifiers can vary from 98.0%–99.8% under normal operation. This evaluation assumed a sludge yield of 0.8 yield and 98% removal efficiency in the secondary clarifiers.
4. Total raw solids consist of primary and secondary solids only. The solids mass balance does not include minor solids loads, such as centrate return solids, as this has only a minor impact on overall solids loads.
5. Primary sludge volatile solids (VS) concentrations can vary greatly depending on the influent characteristics and typically range between 75%–90%. Previous investigations have identified that primary solids are approximately 89% VS. Secondary sludge VS concentrations can range from 75%–90%, and it is assumed that the secondary solids are 80% VS.

Within Option 1A, a separate plant on the West Shore will provide the necessary treatment for the new developments that are expected to occur in that area, plus any conversions of septic tank systems that are near the route of trunk sewers serving the new plant. **Table 2.2** shows the expected flows and loads for the biosolids processing facility at the West Shore site. All biosolids generated at the plant will be treated on site or alternatively depending on the final site location they could be discharged to sewer and treated at the regional biosolids treatment facility.

CAPITAL REGIONAL DISTRICT

Core Area Wastewater Treatment Program

Biosolids Management Plan

Table 2.2 – Option 1A: West Shore Biosolids Facility Design Flows and Loads¹

Item	2030				2065			
	Average (kg/day)	Peak 30-Day (kg/day)	Peak 14-Day (kg/day)	Peak Day (kg/day)	Average (kg/day)	Peak 30-Day (kg/day)	Peak 14-Day (kg/day)	Peak Day (kg/day)
Primary solids ²	2,400	2,800	3,300	3,800	3,700	4,500	5,200	6,000
Secondary solids ³	3,600	4,400	5,100	5,300	5,800	6,900	8,100	8,400
Total raw solids ⁴	6,000	7,200	8,400	9,100	9,500	11,400	13,300	14,500
Total raw volatile solids ⁵	5,000	6,000	7,000	7,600	7,900	9,500	11,100	12,100

Notes:

1. Raw solids production (dry weight) from West Shore biosolids processing site.
2. Typical removal efficiencies for primary clarifiers range from 50%–75%, where removal efficiencies will reduce with high flows or low TSS influent concentrations. It is assumed that 50% of the TSS load is removed by the primary clarifiers.
3. Secondary solids are estimated from conversion of BOD to TSS. Typically 20%–40% of the influent BOD is removed in the primary clarifiers, and it is assumed that 20% of the influent BOD is removed in the primary clarifiers. Sludge yields in the secondary treatment system will vary based on the system SRT, and typical yields can range from 0.4 for a 15-day SRT to 1.0 for a 2-day SRT. In addition, removal efficiencies of the secondary clarifiers can vary from 98.0%–99.8% under normal operation. This evaluation assumed a sludge yield of 0.8 yield and 98% removal efficiency in the secondary clarifiers.
4. Total raw solids consist of primary and secondary solids only. The solids mass balance does not include minor solids loads, such as centrate return solids, as this has only a minor impact on overall solids loads.
5. Primary sludge VS concentrations can vary greatly depending on the influent characteristics and typically range between 75%–90%. Previous investigations have identified that primary solids are approximately 89% VS. Secondary sludge VS concentrations can range from 75%–90%, and it is assumed the secondary solids are 80% VS.

2.3 SOLIDS TREATMENT: OVERALL OBJECTIVES

In addition to the basic objective of treating and disposing of wastewater residuals derived from the liquid wastewater streams discussed above, other primary objectives will drive the selection of a comprehensive and successful biosolids management program. Some of these objectives are driven by the need for system reliability and others by the CRD community ethics to protect the environment. Although many more objectives will help refine the overall program, the principal objectives that will drive the selection of the primary biosolids processing and utilization program are discussed in this section.

2.3.1 Support of Ultimate Utilization/Disposal

As with liquid stream wastewater treatment, which is designed to meet the primary objective of processing the wastewater for ultimate disposition (effluent discharge or reuse), the biosolids system is also driven by the selected ultimate disposition. While a wide variety of wastewater solids processing technologies can be applied to the program, the primary issue with respect to a successful program is properly preparing the biosolids for the selected ultimate beneficial use or disposal alternatives. Therefore, the management plan must first address ultimate disposition and then the details of processing in preparation for that disposition follow. All biosolids alternatives will require sludge thickening to extract a large amount of water, delivering a slurry from 4% to 7% total solids (TS), and dewatering, designed to further extract water resulting in a stackable, wet soil-like product typically containing from 20% to 30% TS by weight. Other processing required will include stabilization, thermal destruction, and/or drying. Stabilization can be accomplished by aerobic or anaerobic digestion but for plants the size of those being considered for CRD, anaerobic digestion is typically the preferred solids stabilization method as it has a lower energy requirement.

2.3.2 Implementation on Required Schedule

The CRD has been requested by the Ministry of Environment and has committed to having the new regional wastewater treatment program in operation by 2016. In addition, the CRD is currently applying for critical funding from senior governments for this project which most assuredly will come with similar timeline restrictions and other limitations with respect to extent and performance of the system. It is vital that any alternatives selected have the capability to be fully operational within this time frame. The CRD may explore phasing the program, but biosolids facilities and end use alternatives must be in place on day one for all flows and loads treated at that time.

2.3.3 Resource Recovery

A goal of the CRD Core Area WWTP project is to optimize the amount of resource recovery from each of the wastewater treatment and biosolids processing facilities developed to serve the sewered area. A number of important resources are recoverable from biosolids and preference will be given to systems and end uses that have the proven ability to maximize the recovery of those resources at reasonable cost.

2.3.4 Reduction of Greenhouse Gas Emissions

Driven by the environmental ethic of the community and senior government initiatives to act responsibly with respect to global warming, a goal of the CRD Core Area WWTP project is to minimize the emissions of greenhouse gases (GHGs). For wastewater treatment in general and biosolids treatment and utilization specifically, there are significant opportunities to go beyond GHG minimization and actually contribute positively to overall GHG emission reduction. These opportunities are intimately connected to resource recovery alternatives and will be fully

explored in this BMP. Preference will be given to systems and end uses that have the proven ability to reduce overall GHG emissions at reasonable cost.

2.3.5 Integration with Solid Waste Management

The CRD has the combined responsibility to manage not only wastewater and resultant biosolids treatment and disposal, but also municipal solid waste (MSW) recycling and disposal. Many of the issues impacting successful management of one of these wastes may also impact the other. Significant synergies can be taken advantage of if the processing and end use of these waste streams are considered together. A goal of the CRD Core Area WWTP project is to optimize the integration of biosolids facilities with the current and future solid waste program. This BMP evaluates alternatives for integration of the processing and end use of these two waste streams. Identification of the potential for integration of the biosolids with the general MSW is very timely because the CRD solid waste management staff is just initiating feasibility studies of the potential for developing an energy-from-waste facility for management of the residual solid wastes remaining after recycling and separation of organic waste.

2.3.6 End Use Reliability: Primary and Backup Alternatives

One thing is certain regarding any wastewater treatment system: Once the system and contributors are in place, the wastewater will not stop coming to the facility. Solids will not stop being generated and the need for processing and end use or disposal will be continuous. There must be someplace to put the resulting biosolids at all times. It is therefore of prime importance that the recommended biosolids utilization/disposal method have maximum reliability and ideally have a backup option which provides flexibility to the CRD in terms of disposal of the end product.

To plan for this high level of reliability, the concept of “primary” and “backup” alternatives has been used successfully to develop diverse, flexible, yet reliable comprehensive biosolids management programs. The fundamental definition of these terms in the context of biosolids management can be described as follows:

- **Backup Alternative:** A handling option that can provide reliable disposal at all times and under all circumstances for all of the sludge generated by the WWTP. A backup alternative must be operational on an as-needed basis at all times and meet the principal criterion of reliability. For this reason, the backup alternative facility and disposal site must be under the complete control of the CRD.
- **Primary Alternative:** Usually driven by a municipality’s objective for beneficial use or resource recovery, the primary alternative is intended to receive most or all of the biosolids generated, but does not have to meet the strict reliability constraints of the backup alternative. Should the utilization system fail for any reason, the biosolids going to the primary utilization option must be readily and quickly transferrable back to the backup alternative, which must remain fully capable of operation.

CAPITAL REGIONAL DISTRICT

Core Area Wastewater Treatment Program
Biosolids Management Plan

To help better understand these definitions, a few examples are helpful. Distribution of a biosolids soil amendment product is a good example of a common primary alternative. Wastewater utilities have successfully marketed and distributed biosolids products for years. However, the utilization and ultimate disposition of the biosolids depends on a continued market for the product, a market that is not under the direct control of the utility. If the market were to fail for any reason, the municipality would still be responsible for finding another end use or disposal option. In this circumstance, the prudent utility has a reliable backup alternative in reserve.

Landfills are quite often the backup alternative of choice (or necessity). The CRD Hartland landfill is a good example of a backup alternative and it is currently used for disposal of biosolids from the Saanich Peninsula plant. The CRD may elect to beneficially utilize all of its biosolids through some market distribution option. The Hartland landfill would be available for backup reliability. Under a robust biosolids management program, if a separate primary method of utilization is used and is successful, no biosolids will ever have to be disposed of using the backup alternative.

Under other forms of biosolids management, the backup and primary alternatives are one and the same. As an example, a waste-to-energy (WTE) facility, burning biosolids and solid waste to produce energy, if owned or under control of the CRD, would serve as a beneficial primary use alternative and would be inherently the backup alternative because it is totally under CRD control. Other examples of backup alternatives are dedicated land utilization or disposal sites, where the land is owned by the agency, and incineration.

Examples of primary alternatives that do not qualify as backup alternatives include forest or agricultural land application on public or private land not owned by the wastewater utility, selling dried and bagged biosolids fertilizer product, and sale of dried biosolids to cement kilns for use as a fuel. The one characteristic these alternatives all share is the lack of reliability from the perspective of end use control by the wastewater utility.

This BMP will evaluate and recommend a robust biosolids program that will meet all of the important objectives discussed above, including having alternative reliability, either inherent in the utilization alternative or through a separate backup alternative.

2.3.7 Process Reliability: Proven Technology

As with biosolids end use reliability, processing reliability is vital to a successful program. Even before developing an excellent, reliable design, including redundant units to act as standby during required maintenance, the selection of well proven technologies is required for system reliability.

When undertaking a major wastewater treatment program such as the CRD, the CRD will be inundated with many new and novel technology suppliers who make many claims with respect to process performance and cost. While many of these technologies show promise, they are

often experimental and have no track record or history at the scale of facilities required for the CRD. Any future assessments of these novel technologies should consider the reliability and track record at a similar scale. Given that for this project there is not sufficient time to reliably prove experimental technologies and the risk to the CRD with respect to process failure would be great, this report assumes that viable technologies are those which are well proven in the industry. For reference purposes we have also reviewed some newer technologies which are being heavily promoted by their developers to provide the CRD with an appreciation for some of the start up and development difficulties experienced by these technologies. Some of these technologies may show promise in the future once the technology is further refined.

2.4 REGULATORY REQUIREMENTS

Historically, biological wastewater solids or “sewage sludge” often created a disposal problem for municipal treatment plant operators due to contamination from metals, pathogens, odour, and public misperception of the value of the product. Treatment technologies have improved over the years to the point where “sludge” is now processed into valuable biosolids products. Treatment facilities can produce energy, reduce their carbon footprint, remediate disturbed land areas, and market a valuable fertilizer product. However, to ensure a successful program concerns about metals, pathogens, emerging contaminants of concern in biosolids products, and air quality, these issues must still be addressed. Regulatory requirements exist at the federal and provincial level in British Columbia to address these concerns, protect the environment, and oversee the management of wastes including biosolids.

The following section provides a summary of issues that are frequently raised for biosolids utilization programs.

2.4.1 Trace Metals

Metals are contributed to WWTPs due to soil contamination, metal piping, and industrial processes. Industrial source control programs have dramatically reduced metals concentrations in biosolids products over the last 30 years. The CRD has implemented for many years a very successful source control program throughout the sewer collection system, which has significantly reduced metal concentrations in the discharges from the CRD outfalls. To ensure protection of the environment and public health, British Columbia provincial government regulations set limits on metal concentration in biosolids and soil. Many of the regulated metals in biosolids are actually beneficial when applied in the correct amounts (OACWA, 2009). Micronutrients such as copper, iron, molybdenum, and zinc are essential for plant growth. The presence of these micronutrients is one reason why biosolids can be more effective in promoting plant growth than conventional mineral fertilizers.

2.4.2 Emerging Contaminants

In recent years, a variety of compounds used in industrial and domestic applications have been detected in trace amounts in wastewater and biosolids. The source of these numerous compounds are widely diverse, but usually from direct human use and contact, including pharmaceuticals, personal care products, plasticizers, surfactants, pesticides, and fire retardants (Kolpin et al., 2002). Since by far most of these compounds enter the wastewater collection system through domestic use and direct human contact, exposure to humans from wastewater or biosolids is less of a concern than potential impacts on downstream environmental systems. Concern exists that these emerging contaminants can be emitted to the environment through wastewater outflows or biosolids application. With potentially adverse impacts on aquatic ecology, biological secondary wastewater treatment processes reduce and remove some of these contaminants through metabolism by wastewater treatment microorganisms and by adsorption on the biosolids. The efficiency of removal of these compounds appears to improve with contact time between the treatment microorganisms and the wastewater. Therefore, the more advanced biological treatment systems which have long solids retention times, such as BNR and MBR technology, are more successful in reducing the concentrations of trace contaminants. However, complete removal of all these sophisticated organics will require application of an advanced oxidation process such as high intensity ultraviolet (UV) radiation combined with chemical oxidation using peroxide. The impacts of these compounds in the environment are currently under extensive investigation although leading research indicates little threat to public health through biosolids use (OACWA, 2009). European investigators have been very active in this field. The U.S. Environmental Protection Agency (EPA) plans to conduct extensive exposure and hazard assessments for these pollutants including toxicity data for humans, solids pollutant concentrations and the fate and transport of these compounds in the environment (OACWA, 2009). Regulatory agencies are currently not requesting additional treatment until the significance of the impact of the residual levels of these compounds following secondary treatment is established. Regulatory trends should continue to be tracked as more of these compounds are identified and their fate in the environment is elucidated.

2.4.3 Pathogens

Biosolids are processed to one of two levels: Class B and Class A. Processing involves various levels of time and temperature to significantly reduce or eliminate pathogenic organisms and protect public health. Class B biosolids are typically the product of aerobic or mesophilic anaerobic digestion and pathogen indicators are significantly reduced but not eliminated. As a result, Class B biosolids have restricted uses and are generally applied to areas where there will be no unintentional contact by the public. Example uses include agricultural fertilizer and soil amendment and mine reclamation.

Class A biosolids products have undergone additional processing at high temperatures (55°C minimum). These products are essentially pathogen-free and suitable for application to areas where public access is more common like golf courses and urban landscape projects. Thermally

CAPITAL REGIONAL DISTRICT

Core Area Wastewater Treatment Program
Biosolids Management Plan

dried or composted biosolids products are also distributed in bags at the retail level. Local examples of Class A products include PenGrow (Victoria/Saanich) and SkyRocket (Comox). Another well known example is Milorganite.

Recent research has investigated the phenomenon of fecal coliform reactivation and regrowth from dewatered biosolids. Findings of these efforts indicate that for some sludges, sudden increases in enumerable fecal coliform occur in digested sludge following centrifuge dewatering. Far fewer instances have been observed with other dewatering technologies. Increasing concentrations of these organisms during storage of biosolids following centrifuge dewatering has also been noted. Reactivation and re-growth of other pathogenic organisms has not been observed, indicating this may only be a phenomenon with fecal coliform. Reactivation and regrowth has not been observed with some digestion technologies, such as the extended thermophilic anaerobic digestion system at Metro Vancouver's Annacis Island plant. Ongoing research is being conducted to address this phenomenon and determine the root cause and potential solutions in order to minimize risk to public health and promote necessary regulatory changes. The CRD and its consultants will continue to monitor progress in this area of research and incorporate any necessary changes in facility configuration to reflect the state of the art in best biosolids management practices to protect the public health and environment.

2.4.4 Air Emissions

A WTE facility or utilization of biosolids in a cement kiln operation will be subject to national and provincial air quality guidelines. The Canadian Environmental Protection Act, S.C. 1999 c. 33 (CEPA) are national standards that manage all potentially dangerous chemical substances. To comply with CEPA's air emission regulations, three sub-regulations must be met. First, emissions must be monitored on a yearly basis for priority pollutants as outlined in the National Pollutant Release Inventory (NPRI). Secondly, trends in pollutant emissions in Canadian cities must be monitored according to the National Ambient Air Quality Objectives (NAAQOs). Thirdly, the Management of Toxic Substances Act requires monitoring of polychlorinated dibenzo-p-dioxins (dioxins) and polychlorinated dibenzofurans (furans), mercury, and chlorobenzenes. In addition to monitoring emissions, the Canadian government has committed to reducing the emissions of particulate matter and ozone by 2010.

Under the provincial Environmental Management Act (EMA), regional districts are required to update their solid waste management plan every 5 years or after any major changes to the waste management system. The plan will need to be updated to record any changes in MSW disposal. Another more significant provision of the EMA is the Waste Discharge Regulation. Under this regulation an operational certificate and/or air permit is required. In order to obtain a permit, a dispersion modelling study and review of ambient air quality will need to be conducted. The modelling study must identify the "point of impairment" and the sensitive receptors. In addition, the air permit will require a monitoring program of pertinent pollutants. A list of the most common and stringent air emissions standards for Canada is shown in **Table 2.3**.

CAPITAL REGIONAL DISTRICTCore Area Wastewater Treatment Program
Biosolids Management Plan**Table 2.3 – Air Quality Monitoring**

Pollutant	British Columbia (mg/Rm ³)	CCME (mg/Rm ³)	Ontario (mg/Rm ³)	EU (mg/Rm ³)
Opacity	5%	-	-	-
Particulates	20	20	17	9.2
Carbon monoxide	55	57	-	45.8
NOx	350	400	207	183
Sulphur dioxide	250	260	56	45.8
Hydrogen chloride	70	75	27 or removal \geq 95%	9.2
Hydrogen fluoride	3	-	-	0.9
VOCs	-	-	-	9.2
THC (as methane [CH ₄])	40	-	-	-
Organic matter (as CH ₄)	-	-	65	-
Arsenic	0.004	0.001	-	-
Cadmium	0.1	0.1	0.014	0.046
Chromium	0.01	0.01	-	-
Lead	0.05	0.05	0.142	-
Mercury	0.2	0.02	0.02	0.046
Heavy metals	-	-	-	0.46
Chlorophenol	0.001	0.001	-	-
Chlorobenzene	0.001	0.001	-	-
PAH	0.005	0.005	-	-
PCB	0.001	0.001	-	-
Dioxin/furans	5.0×10^{-7}	8.0×10^{-8}	8.0×10^{-8}	9.2×10^{-9}

Note: Concentrations are based on a temperature of 25°C and a pressure of 101.3 kPa and are corrected to 11% oxygen and 0% moisture.

The construction of a large-scale MSW-biosolids co-combustion WTE facility requires an additional environmental assessment (EA) according to the provincial BC Environmental Assessment Act (BCEAA) under the Reviewable Project Regulation. To carry out an EA, consultations with the public, government agencies, and First Nations must be conducted throughout the process development and review. A federal CEAA review would also be required for this type of project.

2.4.5 Land-Based Programs

While there are examples of successful land application programs on the BC mainland and Vancouver Island, efforts to develop land application projects on agricultural land within the CRD have been largely unsuccessful. Manufacture of a topsoil product for landscaping and soil improvement is considered more feasible and has met with some success. Therefore, the pertinent regulations presented here focus on small-scale fertilizer use and blended topsoil products.

In British Columbia, land-based biosolids utilization is governed by the Organic Matter Recycling Regulation (OMRR) (BC Ministry of Water, Land and Air Protection, 2002). The OMRR was established in 2002 under the authority of the Waste Management Act and the Health Act and is currently under revision by the Ministry of the Environment. The regulation governs the production, distribution, storage, sale, and use of biosolids and compost.

The regulations provide for two classes of biosolids, Classes A and B, whose characteristics are summarized in **Table 2.4**. Class A biosolids are processed to a higher degree than Class B biosolids, thus having a much lower pathogen concentration in the finished product and much less restrictive handling and land application requirements.

Table 2.4 – Summary of Biosolids Classification Requirements in BC’s Organic Matter Recycling Regulation

Characteristic	Class A Biosolids	Class B Biosolids
Pathogen reduction requirements	<1,000 MPN/g (dry solids basis) to be produced by one of the pathogen reduction processes listed below	<2,000,000 MPN/g (dry solids basis) or one of the pathogen reduction processes listed below
Acceptable processes for pathogen reduction	Thermophilic aerobic digestion at $\geq 55^{\circ}\text{C}$ for at least 30 min	Aerobic digestion with mean cell retention time between 40 days at 20°C and 60 days at 15°C
	Thermophilic anaerobic digestion at $\geq 50^{\circ}\text{C}$ for at least 10 days	Anaerobic digestion with a mean cell retention time between 15 days at 35°C and 60 days at 20°C
	Exposure to time-temperature processing requirements according to arithmetical formulae given in the regulation depending on the TS concentration of the biosolids	Air drying for >3 months, during which the ambient temperature must be $>0^{\circ}\text{C}$ for at least 2 months
	Alkaline stabilization by maintaining the pH within the biosolids >12 for 72 hours during which $T > 52^{\circ}\text{C}$ for 12 hours, followed by air drying to $>50\%$ TS concentration	Lime stabilization such that the pH of the biosolids is raised to ≥ 12 after 2 hours of contact
Vector attraction reduction requirements	Aerobic or anaerobic digestion resulting in $>38\%$ destruction of volatile solids mass or another acceptable criterion specified in the Regulation	Aerobic or anaerobic digestion resulting in $>38\%$ destruction of volatile solids mass or another acceptable criterion specified in the Regulation

CAPITAL REGIONAL DISTRICT

Core Area Wastewater Treatment Program
Biosolids Management Plan

The OMRR also specifies requirements for Classes A and B compost as well as the maximum allowable metal concentrations in biosolids, compost, and soils following land application.

A summary of the quality and sampling requirements for OMRR residuals and products is provided in **Table 2.5**.

Table 2.5 – Summary of Quality and Sampling Requirements for OMRR Residuals and Products

Quality Criteria	Class A Biosolids	Class A Compost	Class B Biosolids	Biosolids Growing Medium
Parameters	Trade Memorandum T-4-93	OMMR Schedule 4	OMMR Schedule 4	OMMR Schedule 4 and 11
Trace elements ($\mu\text{g g}^{-1}$)				
Arsenic	75	13	75	13
Cadmium	20	3	20	1.5
Chromium	Not required	100	1,060	100
Cobalt	150	34	150	34
Copper	Not required	400	2,200	150
Lead	500	150	500	150
Mercury	5	2	15	0.8
Molybdenum	20	5	20	5
Nickel	180	62	180	62
Selenium	14	2	14	2
Zinc	1,850	500	1,850	150
Fecal coliform ($\text{MPN g}^{-1}\text{dw}$)	<1,000	<1,000	<2,000,000	Not required
Foreign matter (%)	< 1 dw, no sharp foreign matter that can cause injury			
(%, dw)	Not required	Not required	Not required	< 0.6
C:N	Not required	$\geq 15:1$ & $\leq 35:1$	Not required	> 15:1
Organic matter (%, dw)	Not required	Not required	Not required	≤ 15
Sampling plan	Systematic, simple or stratified random	Systematic, simple or stratified random	Systematic, simple or stratified random	Simple random
Type of sample	Composite	Composite	Composite, 7 discrete samples for fecal coliform	Composite
Number of samples (minimum)	3 (each composed of 7 subsamples)	3 (each composed of 7 subsamples)	3 (each composed of 7 subsamples)	3 (each composed of 7 subsamples)

CAPITAL REGIONAL DISTRICT

Core Area Wastewater Treatment Program
Biosolids Management Plan

The OMRR does not specify the maximum trace element concentration for Class A biosolids, but refers to Trade Memorandum T-4-93 (September 1997), Standards for Metals and Fertilizers and Supplements under the Canadian Fertilizers Act. The Federal Fertilizers Act does not have limits for chromium and copper. Consequently, there are no set limits for chromium and copper in Class A biosolids even though there are concentration limits for biosolids-amended soil as described in Schedule 10 of the OMRR. The most conservative approach in developing a product is to meet the biosolids growing medium (BGM) standards for the majority of the parameters and the biosolids standards for fecal coliform.

Direct application of Class A biosolids can occur for volumes less than 5 m³ per parcel of land per year. For amounts greater than this volume, a land application plan must be completed prior to application. The land application plan must include the following:

- The location of the application site and written authorization from the registered owner
- A description of the biosolids to be applied including physical characteristics, nutrient, fecal coliform, and trace element concentrations
- Storage and leachate management requirements at the application site
- The intended date application will commence and the application rate
- The projected trace element concentrations in the soil after application
- A post-application monitoring plan if the application rate exceeds annual crop
- Nutrient requirements.

However, OMRR-compliant BGM can be distributed with no volume restriction. Sampling of the BGM is required to determine compliance with the OMRR. Sampling and analysis must be completed at least every 1,000 dry tonnes (DT) of BGM or once per year, whichever occurs first.

2.5 REFERENCES

Stantec Consulting, Ltd./Brown and Caldwell, "Core Area Wastewater Treatment Assessment of Wastewater Treatment Options 1A, 1B and 1C," for the Capital Regional District, September 16, 2009.

BC Ministry of Water, Land and Air Protection, 2002. Organic Matter Recycling Regulation.

Kolpin, D.W., Furlong, E.T., Meyer, M.T., Thurman, E.M., Zaugg, S.D., Barber, L.B., Buxton, H.T.. "Pharmaceuticals, Hormones, and Other Organic Wastewater Contaminants in U.S. Streams, 1999–2000: A National Reconnaissance." Environmental Science & Technology. 2002. March 15:36(6) 1202–11

OACWA, 2009. Biosolids Fact Sheet. Oregon Association of Clean Water Agencies.

Section 3 Biosolids Beneficial Use and Disposal Alternatives

This section provides an overview of the fundamental categories of options for ultimate use and/or disposal of biosolids generated from wastewater treatment. The benefits and drawbacks of each option are explained, typical energy balances are provided, and relevance to the CRD Wastewater Management Program is discussed. The following options are included in the analysis:

- **Fertilizer and Soil Amendment Alternatives**
 - Fertilizer products: anaerobically digested and thermally dried biosolids
 - Fertilizer products: topsoil blending with or without thermal drying
 - Mine reclamation
 - Class A lime-pasteurized fertilizer
 - Composting
- **Energy Production Alternatives**
 - Biomass production
 - Biocells
 - Biosolids for fuel: cement kiln or other thermal fired processes
 - Biosolids for fuel: waste-to-energy (WTE)
 - Thermal processing (gasification, etc.) to produce marketable fuel
- **Backup Alternatives**
 - Landfill sludge at Hartland
 - WTE facility
 - Incineration
 - Dedicated land utilization
 - Dedicated disposal site separate from Hartland landfill

CAPITAL REGIONAL DISTRICT

Core Area Wastewater Treatment Program Biosolids Management Plan

The fertilizer alternatives are land utilization-based alternatives in which the nutrient or soil building properties of biosolids are used. The energy production alternatives are thermal-based systems that use high heat processes to burn or thermally process the biosolids to generate electric power and heat or produce a by-product fuel that can be used or marketed.

Section 3.1 describes fertilizer options in detail. Section 3.2 describes energy production options. Section 3.3 describes which beneficial use alternatives qualify as backup alternatives (as defined in Section 2.3.6) and describes a few additional backup options that are purely disposal alternatives with no beneficial use. Finally, Section 3.4 describes pass/fail criteria used to cull undesirable alternatives from further consideration and ends listing remaining backup and primary alternatives retained for further consideration.

3.1 FERTILIZER AND SOIL AMENDMENT ALTERNATIVES

Conventional fertilizers are used to increase plant yield. Biosolids fill this same objective but also provide additional benefits to the soil while requiring less energy for production. These advantages over conventional fertilizers are outlined in **Table 3.1**.

Table 3.1 – Comparison of Chemical Fertilizer and Biosolids

Fertilizer Comparison	Chemical Fertilizer	Biosolids
Provides nitrogen	✓	✓
Supplies micronutrients	-	✓
Slowly releases nutrients	Occasionally	✓
Introduces organic matter	-	✓
Increases soil water holding capacity	-	✓
Emits GHGs during production	✓	-
Rehabilitates damaged soil	-	✓
Sequesters carbon	-	✓

Biosolids contain plant nutrients, such as nitrogen, phosphorous, and sulphur, in organic and inorganic forms. The inorganic forms are immediately available to plants. Nutrients in the organic form are released slowly as the biosolids decompose in the soil, providing plants with nutrients throughout the year when additional fertilizer application is prohibited. The slow release of nutrients gives biosolids an advantage over chemical fertilizers, which only supply nutrients for a short period. Biosolids also supply needed micronutrients such as zinc, copper, boron, molybdenum, manganese, and iron. The availability of these nutrients results in plant growth yields much higher than what can be achieved through conventional fertilizers, as can be seen in **Figure 3.1** below. After biosolids application the width between growth rings increases drastically indicating an increase in biomass production.

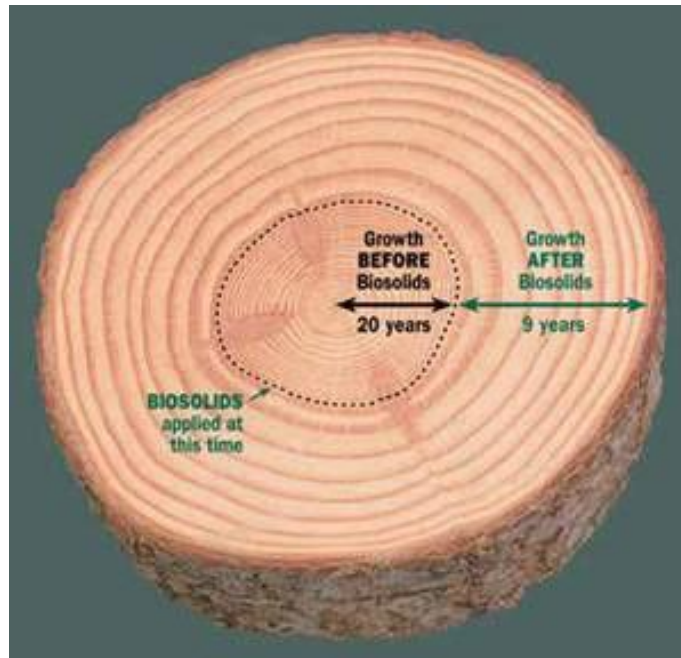

Figure 3.1 – Tree Growth before and after Biosolids Application (NBMA, 2009)

Given the benefits of biosolids as a fertilizer, multiple types of biosolids fertilizers were investigated as a reuse option for CRD.

The regulations, distribution issues, and sampling and monitoring requirements associated with the fertilizer alternatives are generally similar and are summarized below. Where specific regulations or distribution issues apply to fertilizer alternatives, they are described in more detail in the following sections for each alternative.

3.1.1 Regulatory Requirements

Biosolids fertilizers will be regulated under the OMRR. This regulation is discussed in Section 2.4.5. Regulations address product quality and restrictions on use.

3.1.2 Distribution

Biosolids fertilizer products may be distributed directly from a CRD-owned facility. In some cases like composting or topsoil blending, partnering with a private entity may be beneficial. Assumptions for this study focus on the CRD-based option but are not meant to exclude future private sector partnering opportunities.

3.1.3 Sampling and Monitoring Requirements

All fertilizer products will need to be tested for pathogens, nutrients, metals, pH, and moisture. Frequency of testing depends on the production volume. Test results will need to be submitted to the Ministry of the Environment for approval and would form part of the plant Operating Certificate.

3.1.4 Fertilizer Product: Anaerobically Digested and Thermally Dried Biosolids

3.1.4.1 Process Overview and Benefits

A thermally dried biosolids product has universal applications. The dried biosolids can be supplemented for fuel, land-applied for reclamation and other soil improvement projects, or blended with other materials to create topsoil. The cost of transport is much reduced compared to dewatered cake due to volume reduction. To haul the same quantity of biosolids, 3–4 times as many truckloads would be required to transport the cake compared to a dried solids product.

Biosolids are dried in two stages. First, digested biosolids are mechanically dewatered using a centrifuge, belt filter press, or other equipment. Dewatered biosolids “cake” can be further dried using a thermal process. While dried solids are the most versatile of the fertilizer products, they also require the most energy to produce. In general, biosolids after dewatering will be concentrated to about 20%–30% solids. It then takes approximately 5,000 kJ to evaporate 1 kg of additional water from the material (Metcalf & Eddy). If 15 DT of biosolids are produced per day, then 177 GJ are required to evaporate the additional water from the material, assuming 30% TS content and production of a 95% dry product. This calculates out to 64,515 GJ per year. Digester gas can be used to dry the biosolids on site with no additional energy cost; however, this would reduce the surplus amount of gas available for other beneficial uses such as commercial sale or power generation. Recovery of waste heat and use of low to medium temperature belt drying systems is planned for the CRD facilities to minimize energy required for thermal drying.

Example Program: Pierce County (Washington State) SoundGRO

Pierce County SoundGRO is a dry pelletized fertilizer that is produced in seven steps: dewatering, mixing, air drying and solids separation, pellet sorting, pellet cooling and storage, and air treatment and recirculation. These steps are portrayed in **Figure 3.2**.

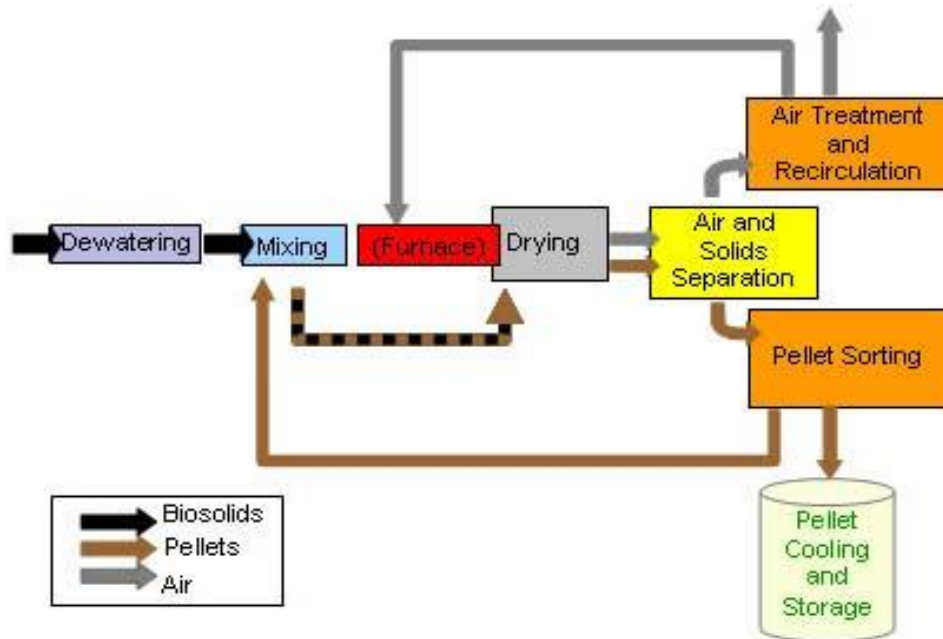

Figure 3.2 – Fertilizer Manufacturing Facility in Pierce County

(source: <http://www.co.pierce.wa.us/pc/abtus/ourorg/pwu/sewer/soundgro/fertilizermanufacturing.htm>)

The final product is a Class A, exceptional quality (EQ) biosolids product that is 93% dry matter. The product is marketed as a slow-release fertilizer with a nitrogen:phosphate:potassium (N-P-K) ratio of 5-4-0 that is ideal for lawns and gardens. SoundGRO is distributed through private operators in 23-kg bags, by bulk order, or through landscaping services.

3.1.5 Topsoil Blending Without Thermal Drying (Class A anaerobically digested dried product mixed with sand and wood waste)

3.1.5.1 Process Overview and Benefits

Biosolids blended with sawdust, woodchips, yard clippings, or crop residues make excellent mulches and topsoils for horticultural and landscaping purposes. The proposed project soil product will consist of 2 parts dewatered cake, 2 parts sawdust, and 1 part sand. Alternatively, thermally dried biosolids can be mixed with smaller amounts of amendment. Sand is used to increase porosity, provide structure, and improve drainage. The sawdust is a bulking agent that provides airspace, makes the mixture more permeable, and serves as a moisture absorbent. In addition, the sawdust helps mediate the C:N ratio. A maximum C:N ratio of 30:1 prevents drawing nitrogen from the plants when using the biosolids as a soil conditioner as well as minimizing the release of nitrous oxide (N₂O), a potent GHG. The off-gassing of properly aerated and conditioned biosolids is primarily CO₂ and water vapour.

CAPITAL REGIONAL DISTRICT

Core Area Wastewater Treatment Program
Biosolids Management Plan

Production of a topsoil amendment requires minimal processing. Dewatered Class A cake or dried product is manually mixed with sawdust and sand at the appropriate ratio. The material is then screened to produce the final product. For CRD it is assumed that dried biosolids can be used for this purpose, but to minimize cost and thermal drying capacity requirements some topsoil product can also be manufactured using dewatered cake.

Example Program: Tacoma's TAGRO

TAGRO, based in Tacoma, Washington, is an exemplary program that has effectively promoted biosolids as a competitive topsoil product. TAGRO has received numerous national and local awards including first place in the EPA Biosolids Recycling Program and the EPA Technology Innovation or Development Activities Award in 2004. The solids are a product of a dual digestion system: first-stage aerobic thermophilic digesters fed pure oxygen, followed by anaerobic digesters operating in a thermophilic/mesophilic range. The Class A solids are dewatered in a two-stage belt filter press. Approximately 3,600 tonnes of dry solids are handled annually.

TAGRO started by distributing its "Classic" product for free. Classic is a basic mix of 2 parts biosolids cake, 2 parts sawdust, and 1 part sand. The product could be picked up from a pile located at the production facility. The product's acclaim grew by word of mouth and now after two decades, TAGRO has developed three commercially competitive product lines that include the Classic, mulch, and topsoil (see **Figure 3.3**). In 2006, TAGRO generated revenue of \$400,000 for the city of Tacoma with a population of 200,000 people (Brown and Thompson, 2007). This is a substantial sum for a product that most municipalities pay to have hauled away.



Figure 3.3 – The Three Commercial Product Lines of TAGRO

(source: <http://www.cityoftacoma.org/Page.aspx?hid=684>)

3.1.6 Mine Reclamation

3.1.6.1 Process Overview and Benefits

Mining has been a central industry in Canada for more than 100 years. However, only recently has legislation been adopted holding miners accountable for the decommissioning and remediation of mining sites. Subsequently, more than 10,000 abandoned mine sites require rehabilitation across Canada (NOAMI, 2009). In 2001, British Columbia committed to the remediation effort by creating a Provincial Contaminated Sites Committee (PCSC). The PCSC identifies potential sites and prioritizes the sites based on human and environmental health risk. To date, the government has spent over \$220 million for remediation of contaminated mine sites (NOAMI, 2009). As of 2008 at least 74 construction aggregate mine operations were occurring locally within the CRD and Cowichan Valley Regional District (CVRD) regions (Sylvis, 2008). The operating and future proposed mine developments in British Columbia are portrayed in **Figure 3.4**.

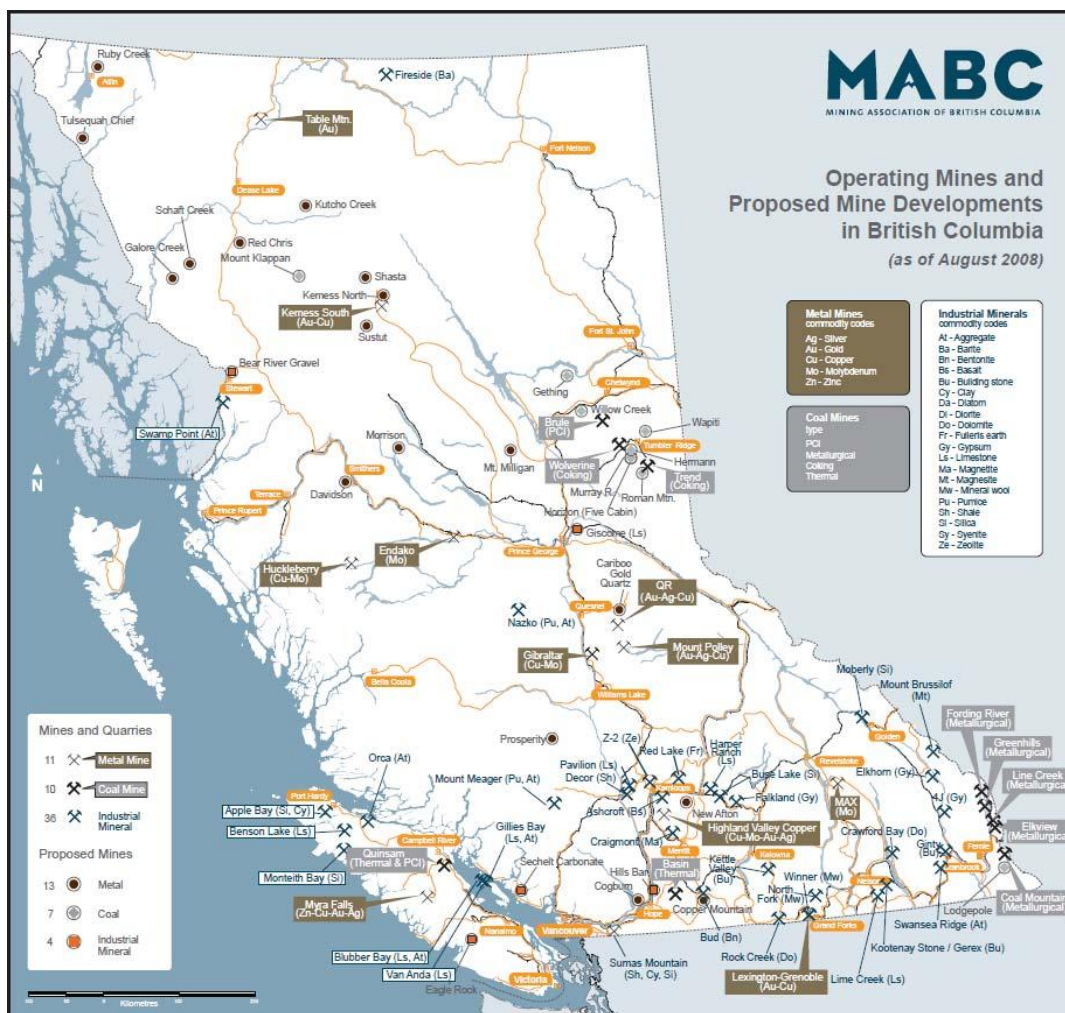

Figure 3.4 – Operating and Proposed Mine Developments in British Columbia (MABC, 2009)

CAPITAL REGIONAL DISTRICT

Core Area Wastewater Treatment Program Biosolids Management Plan

Mining activities degrade the soil, producing large areas of disturbed land. Re-vegetation of cleared areas is necessary to improve aesthetics and reduce spreading of mine tailings and soil erosion. Re-establishment of vegetation on disturbed sites proves difficult for many reasons including the following:

- Lack of nutrients due to low cation exchange capacity
- Disturbed soils have poor water-holding capacity creating drought conditions for plants
- Phytotoxicity due to the presence of metals and acidic pH drainages
- Little to no soil biological activity.

Biosolids have a documented success record as an amendment in remediation operations throughout British Columbia. Biosolids contain 50%–60% organic matter and high nutrient concentrations necessary for re-establishment of plant life. Addition of organic matter improves the water-holding capacity of the soil and provides a matrix to bind and store nutrients. Slow release of nutrients from the biosolids matrix supports the plants for longer than conventional fertilizers, keeping the mine site stabilized. Biosolids are applied at rates much higher than agronomic levels because the biosolids are used to establish a soil-like system instead of merely supplementing an already productive agricultural soil system. **Figure 3.5** shows photographs of the Sechelt gravel mine site before and after remediation with biosolids.



Figure 3.5 – Before-and-after Picture of Reclamation at Sechelt Gravel Mine (Van Ham)

A major advantage of remediating mine sites with biosolids is the potential for GHG credits. A large carbon sequestration credit can be achieved by re-establishing a productive land site. One disadvantage of reclamation as an end-use option is that a disturbed site requires a limited number of solids applications to restore the site. Once a site has been rehabilitated, another site must be identified for continued biosolids reuse.

Example Program: Metro Vancouver

Metro Vancouver’s Nutrifor program distributes the municipalities’ biosolids products and services. Currently, biosolids are recycled in a variety of land application projects including mine reclamation, rangeland, poplar plantation fertilization, and landscaping (Metro Vancouver, 2009).

Mine reclamation is the largest market for Metro Vancouver’s biosolids utilizing 53% of the product (GVRD, 2003). Two of the larger reclamation projects to date include sustaining vegetation on waste rock and tailings piles at Similco Mines in Princeton and Highland Valley Copper in the Kamloops area.

The OMRR regulation does not have an allowance for previously contaminated sites. Because some of the mine tailings and waste rock have high background metals concentrations, a permit must be applied for at each site identified to receive biosolids for reclamation.

3.1.7 Land Application of Biosolids for Agriculture

One end-use option is to land-apply the biosolids on private land as a fertilizer and soil conditioner. The agronomic biosolids application rate can be customized to supply the optimal amount of nutrients for the planned cropping system to minimize environmental impacts due to nutrient runoff. Benefits of land application on agricultural and forest land have been demonstrated in numerous research and full-scale projects. The advantages and disadvantages of land application are outlined in **Table 3.2**.

Table 3.2 – Advantages and Disadvantages of Land Application of Biosolids

Advantages	Disadvantages
Offset commercial fertilizer use, expense, and reduce GHG emissions from inorganic fertilizer production	Transporting the solids to a rural land application site
Sequester carbon in soil	Strict provincial regulatory standards limit application
Reclamation of land: mine, fire damage, deforestation, roadside rehabilitation	Potential for odour
Improved plant yield due to presence of essential macro and micro nutrients	Public perception
Slow release of nutrients from organic forms allowing fertilization for longer periods of time	Large land area required
Increase soil organic matter which improves soil structure and water holding capacity	Individual permits required for each land application sites receiving over 5 m ³ of biosolids
Increased earthworm and soil microbial activity	

CAPITAL REGIONAL DISTRICT

Core Area Wastewater Treatment Program Biosolids Management Plan

In summary, land-applying biosolids improves soil quality while providing essential plant nutrients. Hurdles impeding land application include finding cooperating land owners willing to accept biosolids on a scheduled interval, permitting, odour potential, seasonal operational constraints, public perception, and cost of transport.

According to a 2008 biosolids marketing survey conducted for CRD, sufficient land area is available for successful implementation of an agricultural land application program (Sylvis, 2008). According to the 2006 Statistics Canada Census of Agriculture, the total area of farms was 13,563 hectares (ha) in the CRD and 11,559 ha in the CVRD (Sylvis, 2008). Of this total farm area, 20% is assumed to be cropping systems, such as hay and fodder crops, that are suitable to receive biosolids. This results in a total potential area of approximately 5,000 ha (Sylvis, 2008).

One particular hurdle to land-applying in British Columbia is the strict OMRR soil matrix standards. To ascertain the feasibility of land-applying biosolids, preliminary site life expectancy calculations were developed using the average 2008 nutrient characteristics of the Annacis Island (Vancouver) WWTP biosolids. Based on an average nitrogen requirement of 115 kg/ha an application rate of 7 DT/ha was calculated. If 100% of the biosolids produced from CRD went to land application, a 2,370-ha land area would be required. By applying the biosolids rotationally on one of three blocks of 800 ha once every 3 years, the site life (based on the most limiting metal, Cu) can be extended to 116 years. The OMRR limit, biosolids metals concentration, and expected site life per hectare is listed in **Table 3.3**.

Table 3.3 – Metals Loading and Site Life Expectancy for Biosolids at a Typical Agronomic Rate

Parameter	Units	As	Cd	Cr	Cu	Pb	Hg	Zn
OMRR limit	mg/kg	100	70	300	150	1,000	100	450
Metal biosolids concentration	mg metal/kg biosolids	4.3	2.8	65	1052	67	2.5	1,095
Application rate of metals	kg ha ⁻¹	0.03	0.02	0.47	7.54	0.48	0.02	7.85
Post-application soil concentration	mg metal/kg soil	0.02	0.01	0.24	3.87	0.25	0.01	4.02
Site life expectancy	Years	18,987	20,411	3,768	116	12,186	32,657	336

Note: As=Arsenic, Cd=Cadmium, Cr=Chromium, Cu=Copper, Pb=Lead, Hg=mercury, Zn=Zinc.

Implementation of biosolids land application has proven difficult for CRD in the past. For this reason, the program focus is with other beneficial uses described.

3.1.8 Class A Lime-Pasteurized Fertilizer

3.1.8.1 Process Overview and Benefits

Alkaline treatment processes typically raise the pH of biosolids above 12 for 2 hours to reduce pathogens. According to the U.S. EPA, lime stabilization has been demonstrated to effectively eliminate odours, improve bacterial and pathogenic organism control, and provide stable material for application to agricultural land (Otoski, 1981). However, if the pH drops below 11, biological decomposition will resume and produce odour.

The principle advantages of alkaline stabilization over other processes are low cost and simplicity of operation (Otoski, 1981). The liming agent provides the pathogen kills, negating the necessity for digestion. Lime stabilization can also accommodate major fluctuations in solids production. More advanced processes include time and temperature to provide further pathogen reduction and produce a Class A process. A disadvantage to alkaline processes is that the quantity of biosolids required for disposal is not reduced; in fact, the opposite occurs and the mass of the solids increases with lime addition. This can increase the cost for transport.

Example Program: PenGrow

The Saanich Peninsula WWTP produces a lime-pasteurized biosolids product called PenGrow. To produce this product, the primary and thickened secondary sludge are blended together and dewatered using a rotary press. Lime and heat are provided using a proprietary process called RDP. The RDP process stabilizes dewatered undigested sludge by adding lime to achieve a pH of 12.5 and pasteurizes by heating the solids above 70°C for 30 minutes. The lime and heat stabilization results in a Class A biosolids product. A portion of the biosolids produced are cured in a cover-all building and then distributed as a topsoil product from Hartland landfill.

CAPITAL REGIONAL DISTRICT

Core Area Wastewater Treatment Program
Biosolids Management Plan

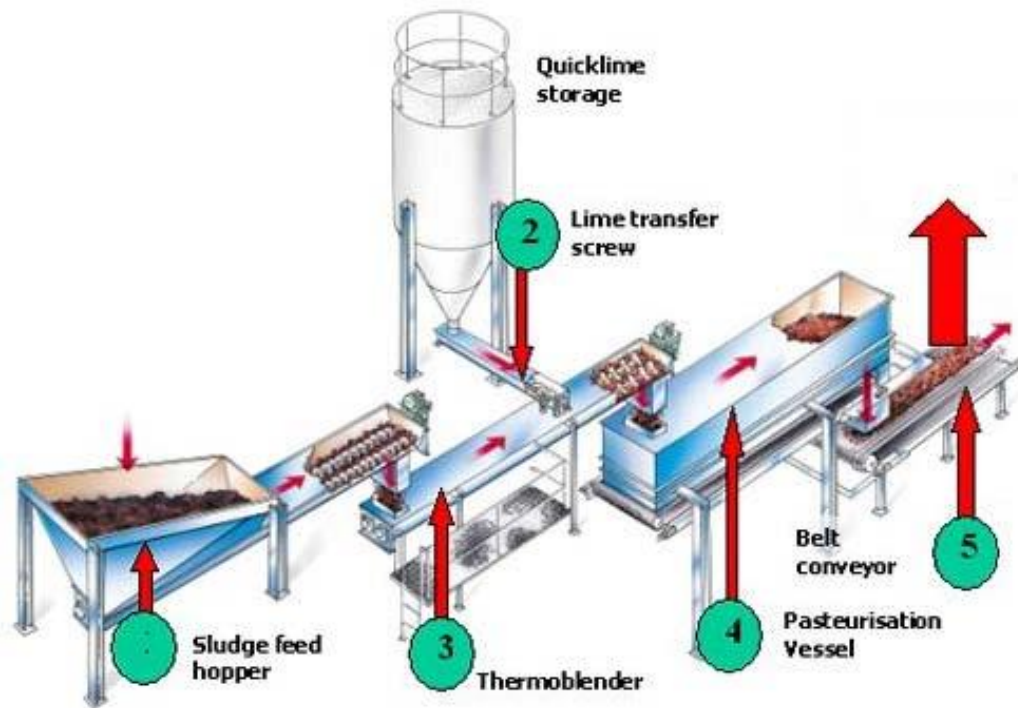

Figure 3.6 – RDP EnVessel Pasteurization Process (RDPtech.com)

The PenGrow biosolids topsoil product was launched in 2008 after a successful pilot study in 2006. During the pilot study, 20 homeowners were asked to use PenGrow on their own gardens and lawns and provide feedback. The feedback was positive and a customer self-help station was established at the Hartland landfill. In 2008, 160 tonnes of biosolids were distributed in this manner. The demand for PenGrow was greater than the amount developed for distribution. The remaining solids (~ 3,000 tonnes) were landfilled.

Improvements to the solids production and distribution process are currently being evaluated to accommodate the high demand. Due to the nature of the lime-pasteurized product, a minimum curing time of 4–6 weeks is required per batch. Because only 80 tonnes can be cured at a time at the existing curing facility, a maximum of 300 tonnes can be cured and distributed annually. Expansion of this facility would allow more material to be cured. A secondary issue that requires resolution is the colour of the biosolids. The lime stabilization process causes the solids to appear light grey or white in colour. A picture of the lime-stabilized solids with regular biosolids is shown in the figure below. The colour is off-putting for gardeners who are used to a dark brown or black colour which is indicative of organically rich soil. One solution may be to add ground clean wood waste to the product.



Figure 3.7 – Lime-stabilized Biosolids (left) Compared to Biosolids without Lime (right)

(source: OMRR, 2008)

3.1.9 Composting

Composting typically requires mixing biosolids with a carbonaceous bulking agent such as sawdust, wood chips, or ground woody yard debris. Composting can be a treatment process using time and temperature to produce a final product that meets Class A pathogen reduction criteria and is highly marketable. Composting other organic materials such as yard debris or food waste can also be done without biosolids, but the process might benefit from addition of thermally dried biosolids product that already meets Class A requirements. Composting biosolids product that has already been treated in a Class A process such as thermophilic digestion or thermal drying simplifies permitting requirements for an independently managed offsite facility.

3.1.9.1 Process Overview and Benefits

The three major composting processes are aerated static pile, windrow, and enclosed vessel. The aerated static pile process maintains aerobic conditions by blowing air through the piled media instead of physical manipulation of the material. Windrow involves piling materials into long rows and then manually turning the piles for aeration. The third process, in-vessel composting, occurs in an enclosed reactor and often involves mechanical turning for aeration as well. An enclosed system allows more process control including collection and treatment of any foul air.

Finished compost product is highly marketable because of its user-friendly, soil-like appearance. Compost can be distributed in bulk for commercial use or provided in smaller quantities directly to the public. Process and quality requirements of the OMRR must be adhered to for this

CAPITAL REGIONAL DISTRICT

Core Area Wastewater Treatment Program
Biosolids Management Plan

purpose. Benefits of compost as a soil amendment are widely known. Costs for producing biosolids compost can be high if bulking agents must be purchased and if a more expensive enclosed system is required.

Composting raw wastewater solids requires different handling processes than composting digested biosolids for a variety of reasons. First, there is a greater occupational hazard when accepting a non-stabilized product and much more stringent measures must be taken in terms of process control. Secondly, odour generation can be greater. But the fundamental issue is that a municipality cannot profit from the net energy credit obtained from anaerobic digestion by using other methods to stabilize and process biosolids. Comox-Strathcona does compost raw (undigested) source material and creates a Class A compost product called SkyRocket. This commendable program has an excellent process control and monitoring regime to ensure safety for workers and adequate product quality. However, the SkyRocket facility is relatively small and not readily scalable to the level required for CRD.

Example Programs: SkyRocket (Comox-Strathcona Regional District) and Ogogrow (Kelowna)

- **SkyRocket**

The liquid stream treatment system for Comox Valley Regional District is a conventional activated system with secondary treatment. The primary and secondary solids are blended and dewatered using a centrifuge. The dewatered solids are then transported to a solids handling facility adjacent to the municipal landfill where the solids are treated to a Class A product on site. The facility handles approximately 1,000 tonnes annually.

To produce the SkyRocket soil conditioner, the Comox Valley Regional District mixes the solids 4:1 by volume with ground wood waste. All wood utilized in a solids product must be clean, unpainted, untreated product. The wood is diverted from the landfill and ground on site. The tipping fee from the landfill (\$65/tonne) covers the cost of wood processing. A small amount of sand is also added to the product to improve appearance and weight. Once mixed, the biosolids and wood waste is composted in an aerobic static pile for 4 weeks. This active process is carried out inside a building where process air is treated in a biofilter system. Next, the compost mix is screened and placed in a covered curing area for up to 12 weeks. SkyRocket is tested for minerals, metals, and coliforms and has consistently passed all OMRR regulations.

The product is marketed as a soil conditioner or supplement. The majority of SkyRocket is purchased by the commercial sector, but a small amount is set aside for bulk sales to individuals. **Figure 3.8** was supplied from the commercial campaign for SkyRocket compost.

These vegetables were planted in...



We planted pumpkins, beans, squash and corn in May. Each garden received seeds from the same pack. By June there was already a significant difference between plants growing in the topsoil mix and those growing in the SkyRocket soil mix. Photos taken June 7, 2007 at the Comox Strathcona Regional District Compost Demonstration Gardens, Courtenay, BC.



Figure 3.8 – Growth Comparison of Conventional Fertilizer to SkyRocket Compost

(source: <http://www.rdcs.bc.ca/notices.asp?id=662>)

- **Ogogrow**

Ogogrow is a soil amendment produced by the city of Kelowna by composting wood chips with dewatered biosolids from the Kelowna and Vernon wastewater treatment plants. The solids are mixed with wood waste comprising wood chips or hog fuel and then composted in a non-aerated static pile. The pile is mixed twice, once after 35 days and a second time after 60–90 days. Once composting is complete the product is screened to remove excess wood waste. The product is also tested for pathogens, nutrient characteristics, moisture, pH, and metals content. Ogogrow is distributed in bulk quantities to local retail outlets, landscapers, nurseries, and orchardists. In 2005, Kelowna sold over 9,000 m³ of Ogogrow bringing in revenue of \$142,500 (Sylvis, 2008). There is a very high demand for this product. The city of Penticton operates a similar facility.

3.1.10 Fertilizer and Soil Amendment Summary

In summary, there are long-term biosolids use opportunities in the CRD/CVRD region for land application in agriculture and forestry as well as development of biosolids fertilizer products (Sylvis, 2008). Use of biosolids solely in mine reclamation does not provide a long-term option but does diversify the biosolids program.

3.2 ENERGY PRODUCTION ALTERNATIVES

3.2.1 Biomass Production (Willow Coppice)

3.2.1.1 Process Overview and Benefits

Coppice refers to the commercial production of trees through short-rotating growth and harvest periods. Once established, trees are harvested every 1 to 4 years for biomass. The wood biomass is chipped and combusted for energy production. The heat value of willow is 19.92 kJ g⁻¹ dry matter. The amount of carbon released during cultivation and transport of trees is roughly equal to the carbon input into the soil (Van de Walle et al., 2007). This is due to the fact that the new trees in the rotation are propagated from the stumps of harvested trees. The underground biomass or roots remain, and decompose adding carbon to the soil. Therefore, coppice production is carbon-neutral and burning of wood chips can offset fossil fuels to reduce emission of GHGs to achieve a negative carbon footprint.

Application of biosolids provides many benefits to the production of short rotation woody crops (SRWC) for biomass. Substituting inorganic N fertilizer with biosolids can increase biomass production and decrease operational costs (Heller et al., 2003). A secondary benefit is that the organically bound fraction of nutrients in biosolids are released slowly, making them available for longer into the SRWC rotation when additional amendment application is prohibitive (Heller et al., 2003).

Example Programs: Campbell River Hybrid Poplar and Swedish Willow Coppice

- **Campbell River Wastewater Treatment Facility**

The Norm Wood Environmental Centre, the Campbell River WWTP provides primary and secondary treatment. Waste activated sludge (WAS) and primary sludge is blended at an in-ground aerobic digester. Digested biosolids are then transferred to an anaerobic holding pond. An overview of the plant layout is shown in **Figure 3.9**.

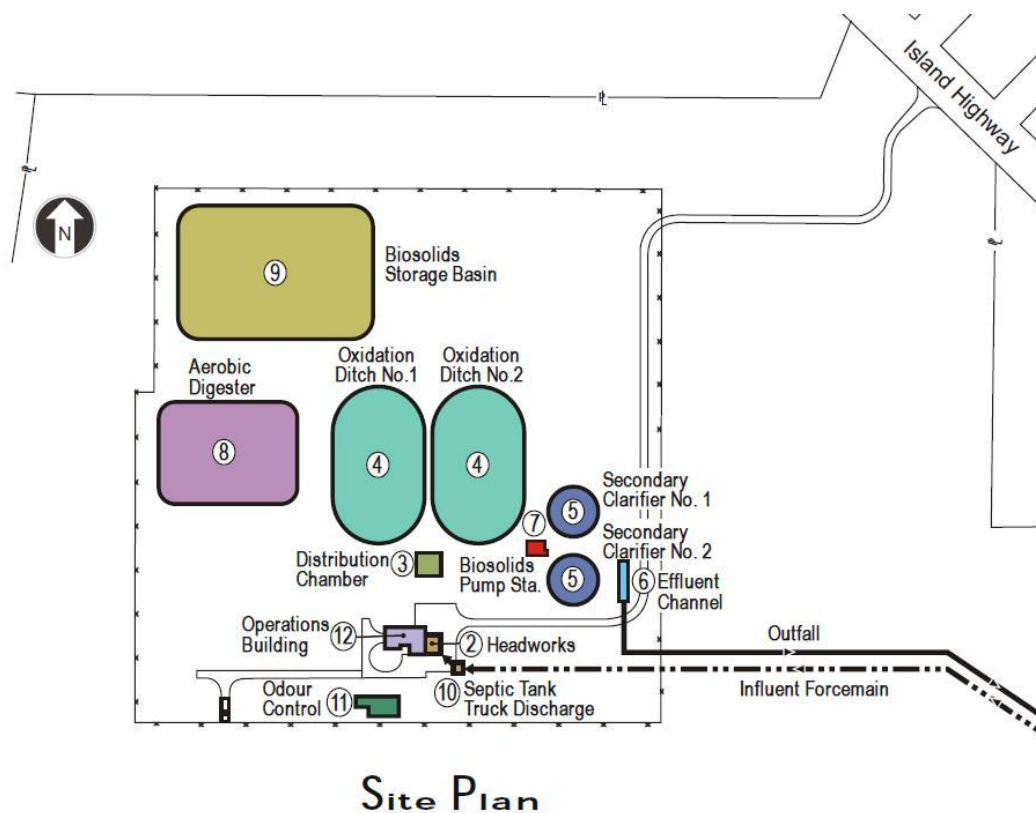

Figure 3.9 – Overview of the Norm Wood Environmental Centre Treatment System

The Campbell River Treatment Division disposes of its Class B solids on a hybrid poplar plantation (shown in **Figure 3.10** below) of 10.1 ha (including buffers) adjacent to the treatment plant. The solids are pumped from the lagoon to an earthen sump located on the plantation. The solids are loaded into a vacuum tanker and applied through a tractor-pulled Aerway SSD applicator. The combined total application to the site is 1,866.6 DT over 5 years or an annual average of 370 DT ha⁻¹ yr⁻¹.

The plantation site was prepped in 2003 and planted with rye crop. In 2004, 4,800 hybrid poplars of two clonal varieties were planted on the application site. The plantation has been thinned twice. In 2007, the trees had reached 6 to 7 metres in height before application of biosolids ceased. Application of biosolids elevated the concentration of metals in the soil. More specifically, the concentration of copper in the soil was approaching 150 mg kg⁻¹, the maximum allowable level in a soil matrix according to the OMRR. Based on the solids loading rate, the concentration of copper in the biosolids, and the OMRR regulations, a 7-year site life expectancy was calculated for this site.

CAPITAL REGIONAL DISTRICT

Core Area Wastewater Treatment Program Biosolids Management Plan

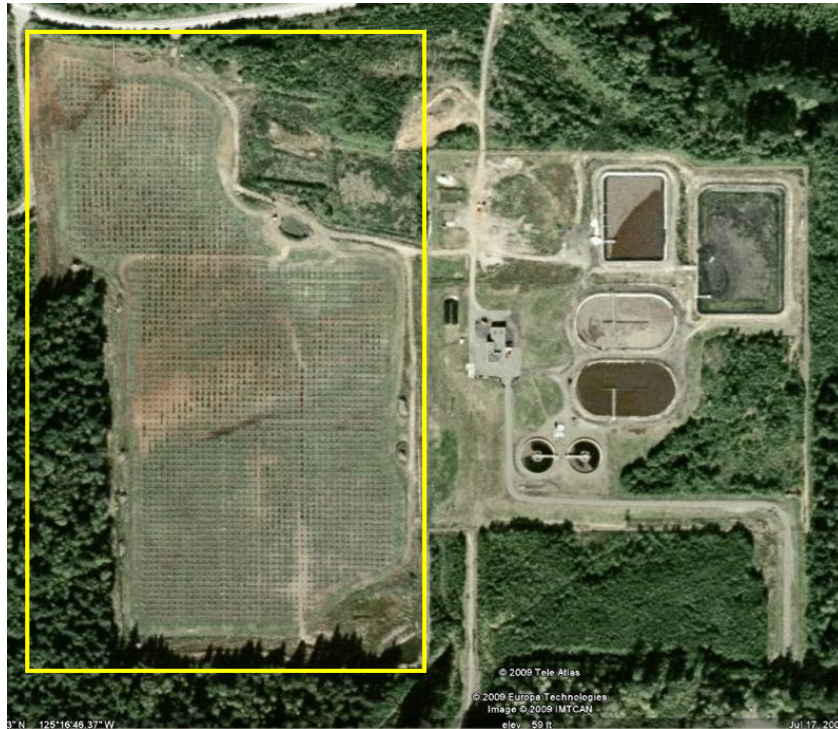

Figure 3.10 – Location of Poplar Plantation Adjacent to the Plant

Project experience indicates that the trees grow at an approximate rate of 2 metres per year using a biosolids fertilizer. The largest problem in site management is soil moisture due to the liquid product application. Given the local climate and broad canopy coverage, the ground was not drying between applications. To allow the soil to dry, loading rates were reduced at times, particularly in wet years.

The Norm Wood Environmental Centre apparently supports the only hybrid poplar plantation receiving biosolids on Vancouver Island. Originally the wood chips were destined for the pulp and paper industry. However, due to mill closures, the demand for short rotation wood is nonexistent. Instead, the wood is chipped and applied on site. The Campbell River team is currently researching alternative crops such as canola for other beneficial reuse opportunities.

- **Swedish Willow Coppice**

Willow coppice production in Sweden is overseen by Agrobränsle. The organization has contracts with 1,250 willow growers and oversees harvesting and transportation to regional district heating plants. As of 2005, 15,000 ha of land was utilized for willow coppice production in Sweden (Dimitriou and Aronsson, 2005). Due to the benefits of the projects, Agrobränsle hopes to expand the area of production to 30,000 ha by 2010 (Larsson and Lindegaard, 2003).

CAPITAL REGIONAL DISTRICT

Core Area Wastewater Treatment Program Biosolids Management Plan

The willow plantations are established by planting stem cuttings. The harvest cycles occur every 3–4 years and the lifetime of a plantation is generally 25–30 years, or 6–10 harvests. Post-harvest, new shoots sprout from the cut stumps. This is particularly beneficial as the root and stump biomass remains on site and is a source of carbon sequestration. Also, processing can be limited to weeding, fertilization, and harvesting. Properly managed stands can produce more than 10 oven DT per hectare annually (Larsson and Lindegaard, 2003).

In general, harvesting occurs during the winter. In 2002/03 approximately 2,500 ha were harvested (of these 40%, or 1,000 ha, were fertilized by sludge). The harvested wood was utilized to provide approximately 200 GWh of energy (Larsson and Lindegaard, 2003). In addition to district heating, the wood can also be used to make syngas, which powers the public bus system.

The demand for wood chips is regulated by the private market. Sweden avoids marketing pitfalls by utilizing the wood products within the municipal system. The wood is used for district heating or for fuelling the public transit system with biogas.



Figure 3.11 – 3-month-old Willow (left) and Harvesting of Willow (right)

(source: renewablefuels.co.uk)

3.2.1.2 Regulations

The OMRR outlines soil application standards for land application plans that do not include site-specific standards. The maximum soil metal concentrations are very limiting. To assess the feasibility of land application on Vancouver Island, the average 2008 nutrient characteristics of the Annacis Island (Vancouver) WWTP biosolids were used to calculate an application rate of 13 DT ha⁻¹ based on an average nitrogen requirement of 200 lb kg⁻¹ ha⁻¹ for hybrid poplar. The OMRR limits, metals concentrations of the Annacis solids, and the life expectancy of a land application site are outlined in **Table 3.4**.

CAPITAL REGIONAL DISTRICT

Core Area Wastewater Treatment Program

Biosolids Management Plan

Table 3.4 – Assessing the Site Life Expectancy of a Biomass Production Site Receiving Biosolids under the OMRR Regulations

Parameter	Units	As	Cd	Cr	Cu	Pb	Hg	Zn
OMRR soil limit	mg kg ⁻¹	100	70	300	150	1,000	100	450
Biosolids concentration	mg metal (kg biosolids) ⁻¹	4.3	2.8	65	1,052	67	2.5	1,095
Application rate of metals	kg ha ⁻¹	0.05	0.04	0.83	13.45	0.86	0.03	14.00
Soil concentration, post-app.	mg metal (kg soil) ⁻¹	0.03	0.02	0.43	6.90	0.44	0.02	7.18
Site life expectancy	years	3,547	3,813	704	22	2,276	6,101	63

Note: As= Arsenic, Cd=Cadmium, Cr=Chromium, Cu=Copper, Pb=Lead, Hg=mercury, Zn=Zinc.

Based on these assumptions, the site life of 1 hectare receiving 13 DT of biosolids is limited by copper at 22 years. To reiterate, copper concentration limits for Class A biosolids are not an issue but biosolids application will ultimately result in exceedance of soil limits. For the CRD, it is not anticipated that willow coppice will be a viable full scale option, however a pilot study may need to be conducted to fully evaluate this option.

3.2.1.3 Hauling and Application Rates

Dewatered or dried product would be hauled by truck or rail to an unidentified location. From a logistical standpoint, the glacial outwash plain in the vicinity of Comox-Strathcona should be considered. Application rates would be on the order of 13 DT/ha to meet crop nutrient requirements. Approximately 45 ha would be required to implement such a program at pilot scale.

3.2.1.4 Sampling and Monitoring: Biosolids, Soil, and Groundwater

Land application of biosolids requires more sampling and monitoring than the other options. Extensive monitoring would be recommended to validate the safety of land application. Observation wells would be installed so that groundwater can be monitored. In addition, soil and biosolids samples would be taken pre- and post-application. The samples would be tested for nutrient value, pH, pathogens, and metals content.

3.2.2 Biocells

A biocell is an innovative closed loop landfill reactor system that is operated in three stages. In the first stage, the bioreactor mimics an anaerobic digester to capture biogas released from decomposing biosolids mixed with solid wastes. The captured gas can then be converted to power. The anaerobic stage is maintained at a critical moisture level through leachate recirculation. After 5–6 years, the gas generation rate decreases and the biocell is converted to an aerobic composting system. Air is injected into the solid waste using the same infrastructure used for gas collection. The aerobic phase occurs until the waste is sufficiently stabilized, approximately 1–2 years. The cell can then be mined for compost material and other

CAPITAL REGIONAL DISTRICT

Core Area Wastewater Treatment Program
Biosolids Management Plan

recyclables. Multiple cells will be operated consecutively, so that each cell can be in either composting, mining, or filling phases.

Biocells are designed with the following components: groundwater control system, composite liner, leachate collection system, liquid/leachate injection system, landfill gas collection/air injection system, bio-cap intermediate covers to oxidize methane (CH_4), final cover system, and a monitor sensor system. A schematic of a biocell is illustrated in **Figure 3.12**.

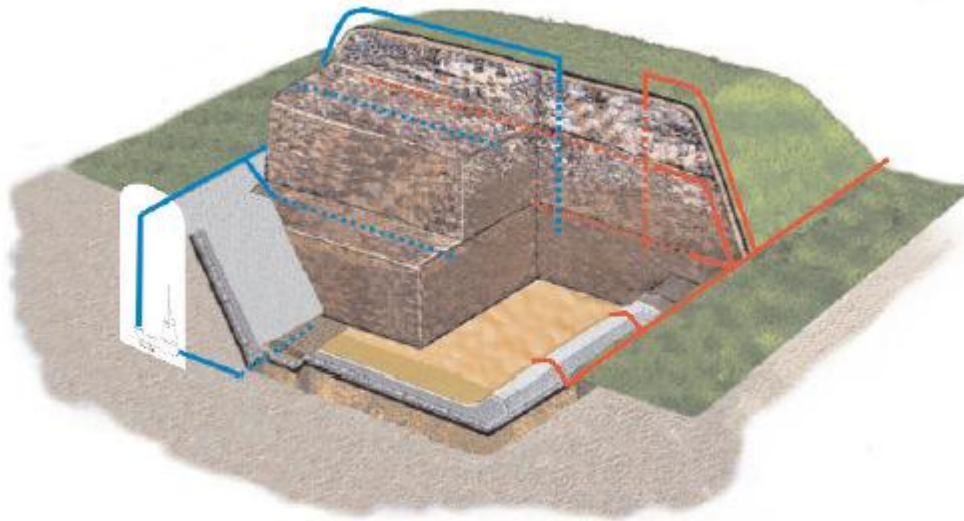

Figure 3.12 – Schematic of Biocell (Stantec, 2006)

A biocell provides multiple advantages over a traditional landfill system. The system enhances anaerobic microbial action, resulting in increased gas capture and power production. Stabilization of waste occurs in a shorter period of time. Also, compost material and other recyclables are recovered during the “mining” stage. Finally, the space and infrastructure within the reactor is reusable.

A biocell system could be beneficial as a backup to receive any overflow biosolids when seasonal demand is low or if complications arise in the solids dryer. The biocell provides a biosolids disposal option that is independent of fluctuations in the private market. One major design consideration is the fact that Hartland landfill is not a lined site and relies on a positive hydraulic gradient to allow the leachate to flow through underdrains to leachate lagoons. The landfill is covered with gravel instead of an impermeable layer to allow water to permeate through the profile. The designed biocell must take this existing condition into account and lining and a leachate collection system would likely be required.

Example Program: Calgary Biocell

The city of Calgary has commissioned a full-scale design and implementation of a landfill biocell. Operation of the biocell can be seen in **Figure 3.13**.



Figure 3.13 – Biocell in Operation (Stantec, 2006)

The landfill biocell (LBC) is designed to accept 55,000 tonnes of residential and commercial waste and approximately 30,000 tonnes of biosolids. The LBC volume is 130,000 m³. The biocell is designed with multiple cells, each with a processing life cycle of 7–8 years per cell. The components of each cell are described in the process overview above.

The benefits of the biocell for Calgary include energy production and waste recycling. During the anaerobic stage, projections indicate that 2.2 m³/minute of CH₄ will be produced. By capturing this CH₄, 275 kW of electricity will be generated. During the aerobic phase, a compost product will be stabilized. A third benefit is reduction of GHG emissions compared to a traditional landfill. The intermediate bio-cap as well as the final cover system oxidize any CH₄ released from anaerobic decomposition. In 2006, the Calgary biocell was awarded with a Consulting Engineers of Alberta (CEA) Showcase award for excellence in environmental management.

3.2.3 Biosolids For Fuel: Cement Kiln

3.2.3.1 Process Overview and Benefits

Cement production can be simplified into five steps (Werther and Ogada, 1999). First raw materials are dried, crushed, and milled. Feedstock for cement typically includes limestone, clay, slag, sand, and iron ore. Next the processed material is suspended in flue gas and separated in an electro-filter (ESP). In the third step, the separated material is carried suspended in air to the rotary kilns or cyclones. The material is preheated to 800°–850°C to form cement. The cement is then cooled with combustion air. A secondary firing may be employed. The first firing provides energy to the rotary kiln, while the second firing is required to maintain sufficient temperature to the cyclone preheater (Werther and Ogada, 1999).

Dried biosolids can be utilized at two different points in this process. The dried solids can be co-fired with coal to heat the main and secondary firing stages. Secondly, the biosolids ash is similar to the feedstock in composition and with a few minor adjustments can be used as part of the raw material feed for cement production. A comparison of composition of cement and biosolids ash is outlined in **Table 3.5**. The ash with lime stabilization has a composition most similar to the cement. In other combustion operations such as WTE, the ash is typically transported and disposed of in a landfill.

Table 3.5 – Composition of Cement and Biosolids Ash¹

Components	Cement	Biosolids Ash (no lime)	Biosolids ash with 0.4 kg CaO/kg
Weight % (dry)			
SiO ₂	21–24	30–49	15–25
Al ₂ O ₃	4–6	8–15	4–8
Fe ₂ O ₃	3–4	5–23	3–12
CaO	64–66	9–22	55–61
MgO	1.5	1–2	0.5–1

1. (Werther and Ogada, 1999)

Two cement kilns are in operation in Vancouver, BC. Metro Vancouver may supply dried biosolids to one of these in the future. Personal communications with the kiln operators indicates additional capacity and interest in receiving dried product from Victoria (Lafarge, personal communication).

3.2.3.2 Regulations

The cement kilns are currently in operation and therefore already have established air emissions permits. An overview of the monitoring requirements can be seen in Section 2.

3.2.3.3 Transportation and Hauling

Multiple options exist for the transport of solids to cement kilns located near Vancouver. One option is that the thermally dried product can be trucked and ferried to Vancouver from Victoria Harbour. A second option involves transporting the solids via rail to Nanaimo where a container ferry will transfer the solids to the mainland. Depending on the final location of the biosolids treatment and drying facilities there is also opportunity to transport the dried biosolids to the mainland by barge.

3.2.4 Biosolids For Fuel: Waste-to-Energy

3.2.4.1 Process Overview and Benefits

WTE is a general description of the process of converting a waste product or by-product into a usable form of energy (electric power, heat, or fuel) and are high-heat, high-energy processes intended to produce the energy product. Like any other energy conversion or energy production systems, the first law of thermodynamics applies (conservation of energy): *Energy can neither be created nor destroyed; it can only change forms.* Therefore, the theoretical maximum energy output is equal to the amount of energy in the fuel source. In reality, any system will have losses due to inefficiency and in the conversion between forms. Biosolids can be fed to WTE systems either alone or mixed with other solid waste such as MSW.

The “waste” product from a municipal WWTP is typically dewatered cake or biosolids at 15% to 30% solids (70%–85% water). The volatile fraction (VF) of the biosolids have an inherent energy value—a typical heating value on a dry-mass basis is approximately 18,000 kJ/kg for digested sludge and 22,000 kJ/kg for raw/primary sludge. However, this energy is not in a usable form and further processing or treatment is generally required. The biosolids can either be incinerated directly or converted to a fuel source via thermal drying. WTE through direct incineration is described in the following section; conversion of biosolids to fuel sources is described in Section 3.2.5, Thermal Processing.

Incineration is a thermal oxidation or combustion process in which the organic matter or VF is destroyed at high temperatures and in the presence of oxygen. Conventional combustion is a well-established technology developed over 100 years ago for energy generation from municipal solid waste. The most common conventional approach is the use of mass burn moving grate systems to combust MSW feed streams. In mass burn systems, waste is fed into a combustion chamber onto one or more grates where several steps occur. The first step reduces water content to prepare material for burning. The next step involves primary burning which oxidizes the more readily combustible material while the subsequent burning step oxidizes the fixed carbon. Waste is burned in sub-stoichiometric conditions, where insufficient oxygen is available for complete combustion. The oxygen available is approximately 30 to 80 percent of the required amount for complete combustion, which results in the formation of pyrolysis gases (flue gas). These gases are combined with excess air in the upper portions of the combustion chamber which allows complete oxidation to occur.

Mass burn technology applications provide long residence times on the grate(s), which in turn produces good ash quality (i.e., less non-combusted carbon). Newer facilities have greatly improved energy efficiency and usually recover export energy as either steam and/or electricity.

Mass burn incineration produces two types of ash: bottom ash and fly ash. Bottom ash can be sent to a landfill following tests to confirm it is safe for disposal. However, it can also be used as construction aggregate, landfill cover, etc. depending on the jurisdiction. Fly ash is generated from the air pollution control systems. As it is classified as hazardous waste, fly ash requires stabilization prior to disposal. A study undertaken for Environment Canada in 2006 provided data regarding the amount of bottom ash and fly ash produced at thermal treatment facilities operating in Canada (four facilities using mass burn incineration and three using multiple stage modular technology). An analysis of the residues created during the treatment process indicates the average quantity of bottom ash produced was 25% by weight of input material¹. An additional 4% by mass of the input waste was produced as fly ash and air pollution control residue. If the bottom ash can be marketed for another use, the residual requiring disposal is approximately 5% of the mass of the incoming waste².

Mass burn facilities can be scaled in capacity anywhere from approximately 36,500 to 365,000 tonnes per year (tpy)^{3,4}. These facilities generally consist of multiple modules or furnaces and can be increased in scale as the required. In addition, individual modules can be shut down for maintenance or if there is inadequate feedstock⁵. Multiple modules can be accommodated on a single site with some sharing of infrastructure.

Mass burn facilities are considered to be highly reliable, with operating facilities in Europe achieving efficiencies of up to 90%.⁶ Feedstock used at operating WTE facilities include MSW, biosolids, and woody biomass.⁷

Incineration or burning of the waste material can be used to produce hot combustion gases. The hot combustion gases are then routed to a boiler for steam generation and the steam is used to generate power in a steam turbine. A typical schematic of the mass burn process with power generation is shown in **Figure 3.14**. Replacing the condenser or cooling tower with a heat exchanger to provide district or process heating converts this process to a combined heat and power (CHP) facility. A CHP facility significantly increases the overall system efficiency.

¹ GENIVAR Ontario Inc. 2006 *Municipal Solid Waste Thermal Treatment in Canada*.

² AECOM Canada Ltd. 2009. *Management of Municipal Solid Waste in Metro Vancouver – A Comparative Analysis of Options for Management of Waste After Recycling*.

³ GENIVAR Ontario Inc. 2006 *Municipal Solid Waste Thermal Treatment in Canada*.

⁴ AECOM Canada Ltd. 2009. *Management of Municipal Solid Waste in Metro Vancouver – A Comparative Analysis of Options for Management of Waste After Recycling*.

⁵ AECOM Canada Ltd. 2009. *Management of Municipal Solid Waste in Metro Vancouver – A Comparative Analysis of Options for Management of Waste After Recycling*.

⁶ AECOM Canada Ltd. 2009. *Management of Municipal Solid Waste in Metro Vancouver – A Comparative Analysis of Options for Management of Waste After Recycling*.

⁷ Hackett, Colin et al. 2004. *Evaluation of Conversion Technology Processes and Products*. Prepared for the California Integrated Waste Management Board.

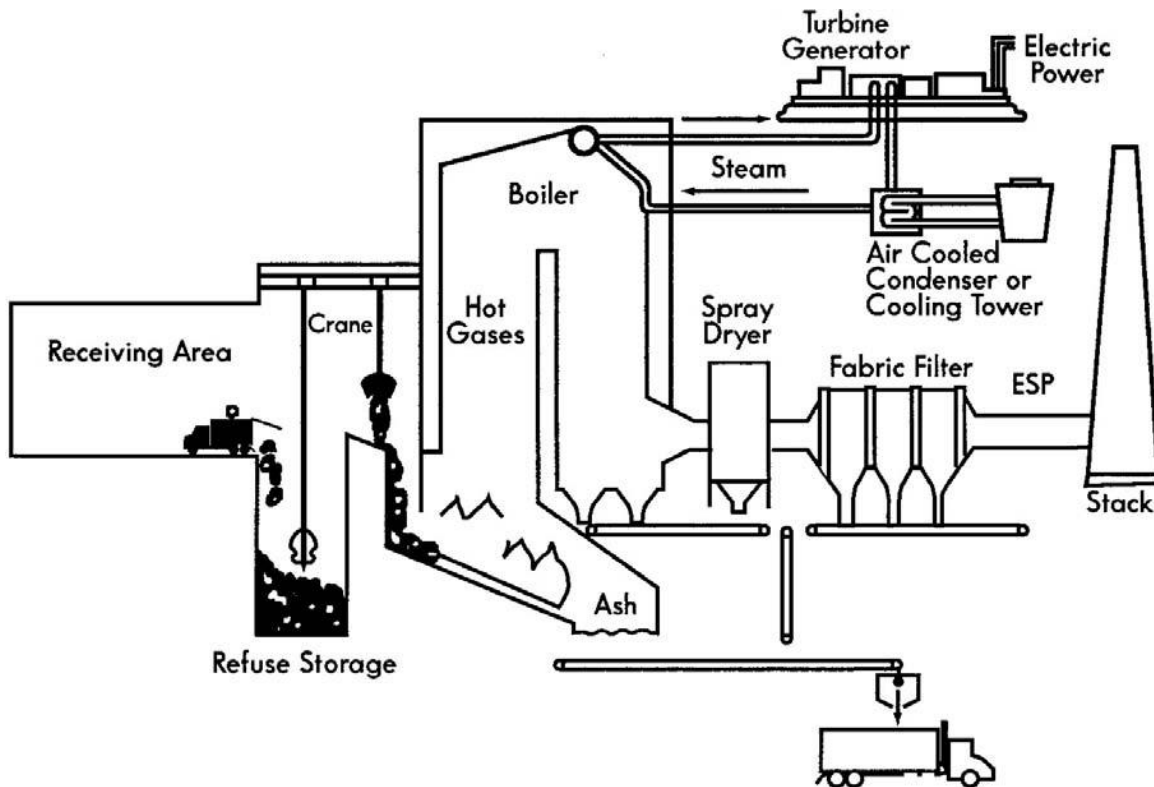

Figure 3.14 – WTE Process Diagram: Mass Burn Facility With Power Generation

Two other conventional approaches commonly used to manage MSW at a WTE facility are:

- **Modular, Two-stage Combustion**

Waste fuel is combusted in a controlled starved air environment in the first chamber. Off-gases are moved into a second chamber where they are combusted in an oxygen-rich environment. The heat generated in the second stage is fed into a heat recovery boiler. Ash is generated in the first stage and is managed in a similar manner as that from moving-grate systems.

- **Fluidized Bed Combustion**

Waste fuel is shredded and sorted, and metals are separated in order to generate a more homogenous solid fuel. This fuel is then fed into a refractory lined combustion chamber. The bottom of the chamber contains a bed of inert material (usually sand) on a grate or distribution plate and a series of air diffusers to provide the fluidizing effect of the sand and air for combustion. Waste fuel is fed into or above the bed through ports located on the combustion chamber wall. Drying and combustion of the fuel takes place within the fluidized bed, while combustion gases are retained in a combustion zone above the bed (the freeboard)—see **Figure 3.15**. The heat from combustion is

CAPITAL REGIONAL DISTRICT

Core Area Wastewater Treatment Program Biosolids Management Plan

recovered by devices located either in the bed or at the point at which combustion gases exit the chamber or a combination. Surplus ash is removed at the bottom of the chamber and is generally managed in a similar fashion as bottom ash from a moving grate system.

Both approaches can be used to manage MSW. However, for fluidized bed applications, the waste must be processed into a more homogenous feed. Both processes generally are more complex than moving grate systems. For that reason, mass burn grate systems are usually assumed in the planning process when considering conventional combustion systems.

Similar concepts are used in the WTE conversion from biosolids only, except that the fuel source transfer and combustion processes may differ from MSW or MSW/biosolids combustion systems. Dewatered biosolids are typically combusted in a fluidized bed incinerator (FBI) or a multiple hearth furnace (MHF). Historically, MHFs are the most used combustion technology for dewatered biosolids, but this is an older technology. Most of the newer dewatered biosolids combustion facilities are FBIs due to their higher efficiency and combustion stability. A schematic of an FBI is shown in **Figure 3.15**. Similarly, dried biosolids can be combusted using FBI or MHF technologies; dried biosolids can also be combusted on a travelling grate similar to MSW. Typically, a FBI would provide higher electrical conversion efficiency than would a moving grate incinerator. Because of their applicability to dried biosolids and greater combustion stability, FBIs are assumed for this project.

For both MHF and FBI, autogenous combustion will occur if the heating value of the dried biosolids exceeds the heat required for water evaporation and thermal oxidation of the VF. Because of the low water content of dried biosolids, the combustion temperature in an FBI is very high and water is circulated through the bed and in the freeboard to reduce temperature. This type is a circulating FBI and is used to create superheated steam. The resulting superheated steam is converted to electrical power using a combination steam turbine generator. No auxiliary fuel is required and energy production is usually at least double that of the power required to operate the system.

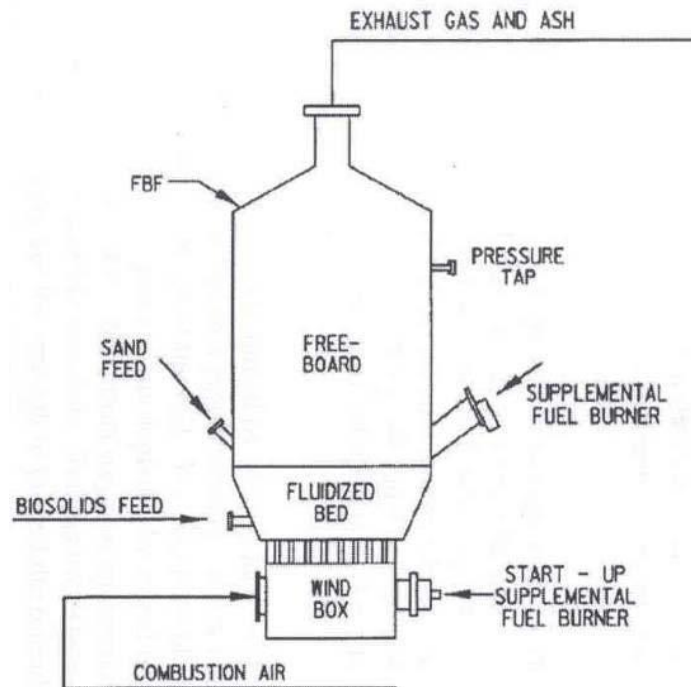

Figure 3.15 – Fluidized Bed Incinerator Diagram (National Biosolids Partnership)

Table 3.6 shows the estimated energy available for four WTE energy facility options for CRD. For all options, it is assumed that biosolids drying energy will be provided by heat pumps (see Section 5). The fluidized bed options (FBI) use dried biosolids only and generates power using a non-condensing steam turbine; therefore, excess steam exists. The WTE mass burn options use dried biosolids as an addition to the MSW feed; the combustion system is a travelling grate and power is generated with a condensing steam turbine.

CAPITAL REGIONAL DISTRICT

Core Area Wastewater Treatment Program
Biosolids Management Plan

Table 3.6 – Energy Balance for WTE Options

WTE Option	Biosolids Input	Power Output	Steam Output	Net Electrical Efficiency		Steam Efficiency		Overall Efficiency
	MJ/tonne	kWh/tonne	kWh/tonne	MJ/kWh	%	MJ/kWh	%	%
Fluidized bed with digested, dried (95%) biosolids	18,000	443 ^{1,2}	3,080 ^{1,2}	40.6	9 ²	5.8	63 ²	70 ²
Fluidized bed with raw, dried (95%) biosolids	22,000	603 ^{1,2}	4,089 ^{1,2}	36.5	10 ²	5.4	67 ²	77 ²
Mass burn with digested, dried (95%) biosolids added to MSW	18,000	1,065 ⁴	0 ⁴	16.9 ³	21	0 ⁴	0 ⁴	21 ⁴
Mass burn with raw, dried (95%) biosolids added to MSW	22,000	1,300 ⁴	0 ⁴	16.9 ³	21	0 ⁴	0 ⁴	21 ⁴

Notes:

1. Non-condensing steam turbine; excess steam may be used for drying and process heating.
2. If a condensing steam turbine is used, there is no usable steam and the net electrical power output and electrical/overall efficiencies are approximately doubled.
3. Provided by Stantec for mass burn facilities; this efficiency value has also been assigned to the biosolids fraction of the feed to the mass burn.
4. Steam is not usable at the Hartland landfill and a condensing turbine is used to extract the maximum amount of electric power.

**Example Programs: WTE Mass Burn: Burnaby, BC, and Cedar Rapids, Iowa;
WTE Biosolids Combustion: St. Paul, Minnesota**

- **WTE Mass Burn: Burnaby, BC**

GVRD's WTE facility in Burnaby, BC, produces 350,000 tonnes of steam and 140,000 megawatt-hours of electricity every year by incinerating 280,000 tonnes of MSW. In this system, no separation of combustible and non-combustible materials occurs. A schematic of the system is shown in **Figure 3.16**; a photo of the facility is shown in **Figure 3.17**. The waste is tipped into a refuse bunker, where an overhead crane mixes and lifts the garbage into a feed chute. The chute transfers the solid waste to a grate, where incineration occurs. The temperature of combustion is process-specific. The non-combustibles or bottom ash drops into an ash bunker to cool. The heat and gases from the burning process are captured in the boiler area to heat water and generate steam. The steam turns a turbine that produces electricity that can be sold to the BC Hydro electrical grid. A heat recovery economizer is used to recover residuals heat, reducing the gas temperature for the cleaning system. The gases are routed through an air pollution control system comprising a lime and carbon injection chamber that captures mercury and acidic gases. Fabric bags are used to filter the gas further to remove more acids, metals, and particulate matter. These small captured particles or fly ash are generally collected and disposed of in a landfill. The gas is then released through the stacks. The bottom ash from the ash bunker can be used as a material in building roads or as a landfill cover material (GVRD, 2007).

Capital cost for the GVRD WTE was approximately \$80 million, including a \$36 million expansion to install the turbo generator in 2003 and a \$7 million heat recovery upgrade in 2006. Annual operations costs are approximately \$11 million per year but revenue from steam and electrical sales offsets these costs.

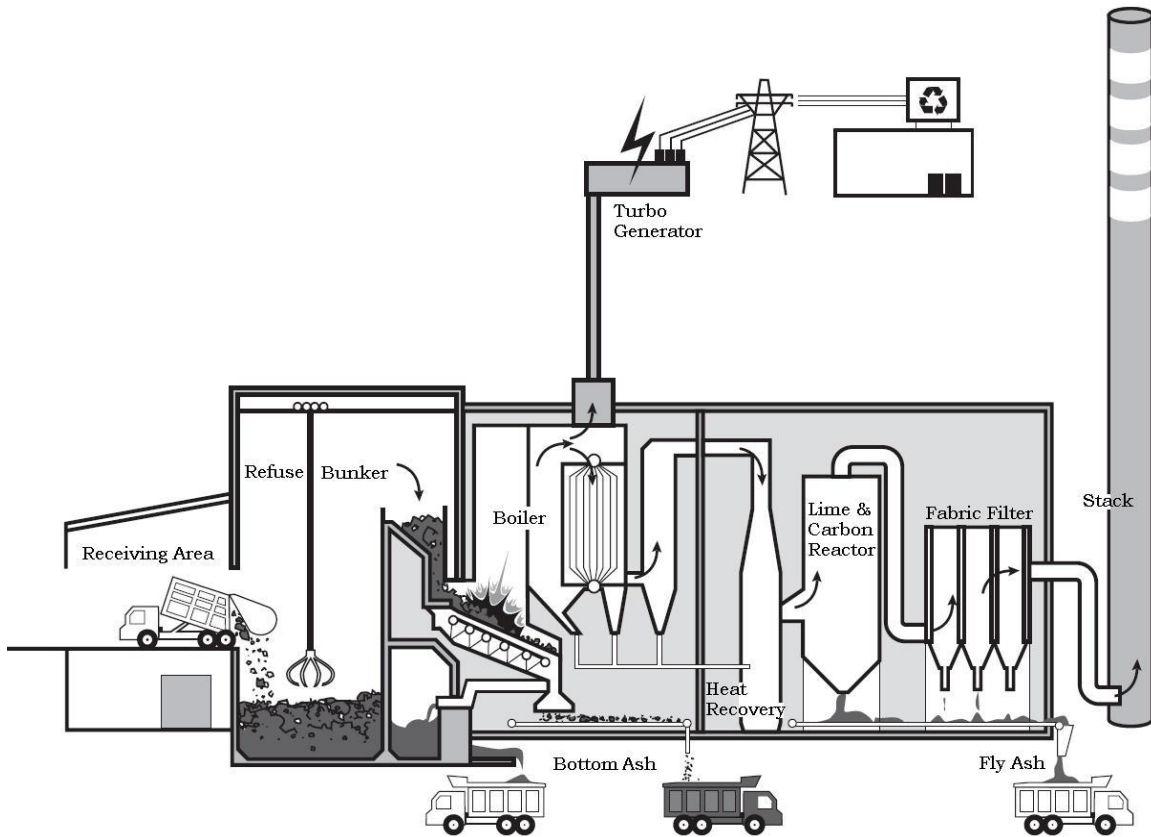

Figure 3.16 – Schematic of the Burnaby Mass Burn WTE Facility



Figure 3.17 – Burnaby Mass Burn WTE Facility

- **WTE Mass Burn: Cedar Rapids, Iowa**

The Cedar Rapids cogeneration WTE facility incinerates a combination of MSW, raw sludge, and auxiliary biomass. The MSW is a mix of food waste, wood debris, plastic, and paper. In this system, only combustible materials are fed to the fluidized bed incinerator; a small fraction is limestone for pollution control (control of acid gases). The total mass feed to the incinerator is 14,860 kg-dry/hr with an energy content of 80.1 MW. Raw sludge at 23% cake is approximately 24% of the feed mass and 27% of the feed energy content. The MSW and biomass make up the rest: food waste (1.5%), wood debris (9%), plastic (20%), paper (28%), and auxiliary biomass (16.5%).

The cogeneration system uses a fluidized bed system followed by a boiler and steam turbine; the system produces 13.5 MW of power and 49.9 MW of steam. An energy comparison of the Cedar Rapids cogeneration facility to other selected WTE and thermal processing systems is listed in **Table 3.7**. A heat recovery economizer is used to recover residual heat, reducing the gas temperature for the cleaning system. The exhaust gases are routed through an air pollution control system that includes a bag house and wet scrubber before being exhausted.

Capital cost for the Cedar Rapids cogeneration facility was approximately US\$228.3 million in 2001. Annual operations costs are approximately \$46.8 million per year but revenue from steam and electrical sales offsets these costs. The net cost/revenue is approximately \$7.4 million.

- **WTE Biosolids Combustion: St. Paul, Minnesota**

The WTE facility for the Metropolitan Council Environmental Services (MCES) incinerates dewatered cake at 27.8% in two fluidized bed incinerators. Each fluidized bed has the ability to process 375 wet tonnes per day of wastewater treatment sludge containing 68% to 84% moisture. The total mass feed to the incinerators is 8,160 kg-dry/hr with an energy content of 46.3 MW. The system uses two fluidized bed systems, each followed by a boiler. The superheated steam from the two systems is combined into a single feed for the steam turbine. The system produces 3.5 MW of power and 2.8 MW of steam. The MCES facility uses an economizer and exhaust gas cleanup similar to those used in Cedar Rapids. An energy comparison of the MCES facility to other selected WTE and thermal processing systems is listed in **Table 3.7**.

Capital cost for the MCES facility was approximately US\$71.5 million in (2001). Annual operations costs are approximately \$13.4 million per year but the facility receives an energy credit of approximately \$0.75 million per year.

3.2.4.2 Regulations (Air Emissions)

An overview of the monitoring requirements can be seen in Section 2.

3.2.4.3 Transportation: Hauling

A WTE facility that combines MSW and biosolids will likely be located at the Hartland landfill and the dewatered or dried biosolids will have to be trucked to the landfill. After drying, the weight of dried biosolids is approximately 25% of the original weight of dewatered biosolids. Because of the lower bulk density of a dried product, the volume of dried biosolids is approximately 40% that of the dewatered biosolids. After the combustion process in the WTE facility, only ash remains. The ash can be landfilled or further processed and transported to a cement manufacturing plant for use as an amendment to the cement.

3.2.5 Thermal Processing to Produce Marketable Fuel

3.2.5.1 Process Overview and Benefits

Thermal processing in this section refers to the process of converting a waste product or by-product into a usable fuel. Thermal processing of biosolids uses high-heat, high-energy processes to produce a marketable or usable fuel in the form of combustible gas, bio-oil, or solid fuel. Each general conversion process is described below and followed by examples. Similar to the WTE facilities, the maximum energy output is equal to the amount of energy in the fuel source. But any conversion process will have losses due to inefficiency, fuel, and power input requirements to the processes, and in the conversion between forms. The gasification and pyrolysis of cellulosic biomass (from agricultural and forestry residues) to produce gaseous fuel, ethanol, and bio-oil are currently being studied in various research facilities and there are a few bench and pilot scale units; there are only few commercial operations. There are even fewer examples of gasification and pyrolysis of biosolids from municipal wastewater treatment plants. The feedstock and process control can have great effect on the fuel product characteristics. Any consideration of thermal processing of biosolids to produce a fuel product should be considered a research and development project.

3.2.5.2 Gaseous Fuel

Gasification is a process being considered as a means to recover the energy contained within the organic fraction of wastewater biosolids. Gasification is accomplished by heating the feedstock under sub-stoichiometric quantities of air and sometimes with the addition of steam. The low oxygen content combusts a small portion of the gases generated—approximately 10-30%. The resultant gaseous products contain carbon monoxide, methane, hydrogen, and other volatile components. This gas stream, known as “syngas” or “producer gas,” is a source of gaseous fuel, which can be combusted and converted to usable energy. A general process flow diagram with various power generation and heat recovery options is shown in **Figure 3.18**. In addition to being combusted immediately after the gasification process, the syngas can be cleaned or scrubbed and used as a fuel substitute.

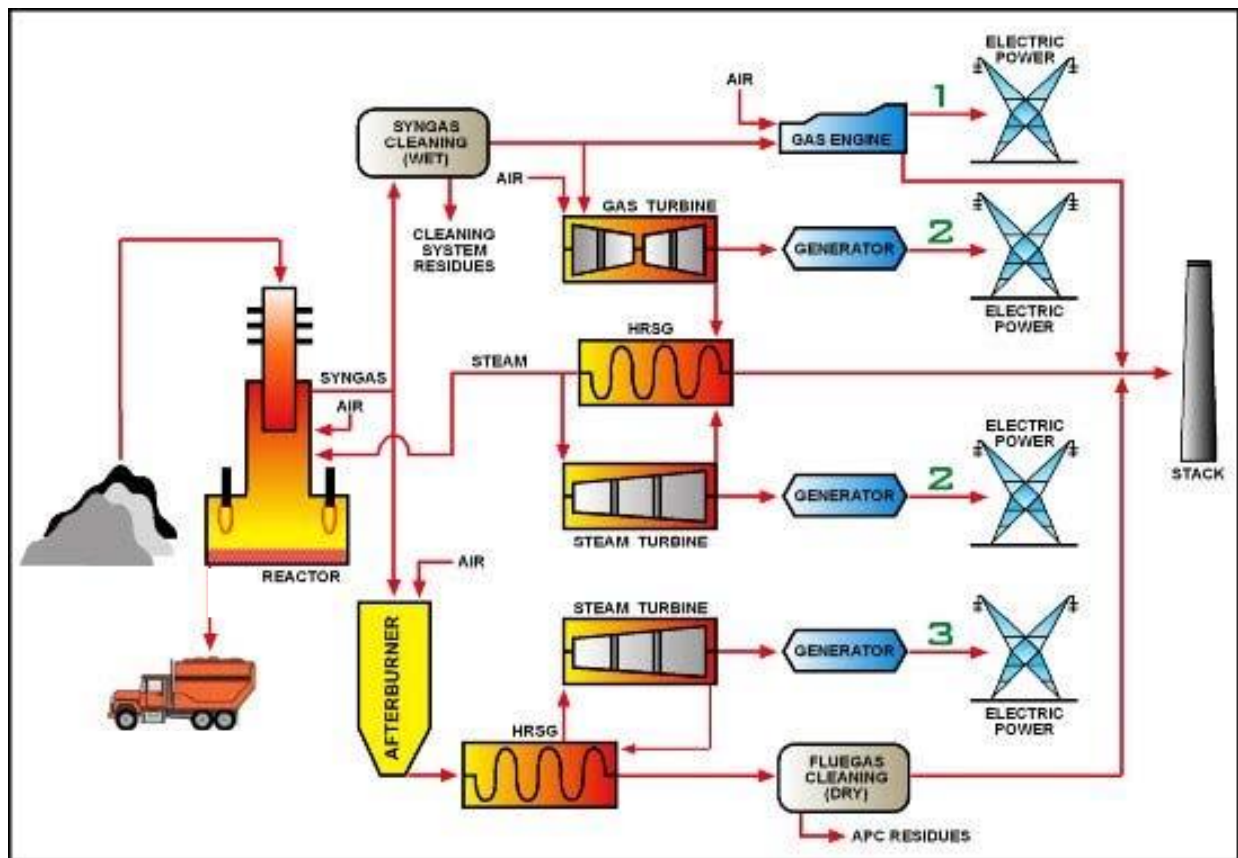

Figure 3.18 – Gasification and Power Generation Processes

Gasification of biosolids is in the development stage and few production-scale units are in operation. Often, the biosolids are mixed with other materials (such as wood waste), increasing fuel content, process stability, and conversion efficiency. Biosolids can generally be gasified only if the moisture content is sufficiently low; a dried product is preferred. Historically, gasification systems have a poor track record and operational problems, such as fusion of entrained ash and control difficulties. The presence of particulate and tars in the producer gas as a by-product of the gasification process presents a significant requirement for treatment. The presence of tars in the producer gas has presented one of the biggest design problems for the technology of gasification and has been referred to as the “Achilles’ heel” of gasification (NREL 1998). While tars at this level may be acceptable for some boilers, internal combustion engines and gas turbines will require reduction in tar levels (NREL 1998, Brammer 2002). The particulates and tars can be removed by physical means (media absorptions, wet-dry scrubbing, filters) and chemical conversions (thermal, steam, selective oxidation, or catalytic conversion).

Example Programs: Nexterra Gasification and KOPF Processes

- **Nexterra**

Nexterra is a fixed-bed, updraft gasifier and is shown in **Figure 3.19**. The figure shows the system using wood waste. The process involves the following main components of the gasification process: (1) the fuel feed system feeds the blended fuel to the gasifier and is designed to maintain a constant height of fuel in the gasifier; (2) the process of gasification is a multi-step process including drying, pyrolysis, gasification, and conversion to ash. Air is introduced at the bottom of the fuel pile at a sub-stoichiometric ratio (typically 20%–30%). This partial oxidation occurs at 815°–985°C (1,500°–1,800°F) and produces the syngas; (3) a moving grate periodically rotates to allow the ash at the bottom of the pile to drop into the bottom conveyors for removal from the process; and (4) the process produces syngas at 260°–371°C.



Figure 3.19 – Nexterra Gasification Process

Nexterra has recently completed a gasification trial using digested, dewatered biosolids at 28% from the Annacis WWTP. At approximately 28% solids or 72% moisture content, the dewatered biosolids are too wet for direct gasification and blending it with dry wood shavings was required to reduce the overall moisture content to 40%–50% (pine wood at about 8% moisture). The testing was conducted at the company’s Kamloops, BC, test facility. Nexterra estimates that the gasifier can accept fuel stock with up to 60% moisture content, but a lower moisture content improves operation and was optimal at 45% (below this amount, there was no need for auxiliary fuel to maintain temperature). The gasification of dewatered biosolids would therefore require additional fuel or a biosolids dryer to reduce the moisture content sufficiently. The biosolids heating value was 7,180 Btu/lb-dry and the wood shavings were at 8,210 Btu/lb-dry. The report for this trial did not provide information on the fuel value of the gas, nor a heat and mass balance to determine the net energy use or production. Nexterra is also working with the University of British Columbia on a system that includes gas clean up.

At the optimum performance of 45% moisture, the total mass feed to the gasifier was 785 kg-dry/hr with an energy content of 3.3 MW. Because insufficient information was provided from the test report, an energy comparison of the Nexterra system is not included in **Table 3.7**.

CAPITAL REGIONAL DISTRICT

Core Area Wastewater Treatment Program Biosolids Management Plan

In addition to the test trials, Nexterra has a wood waste biomass gasifier installed at Dockside Green. The gas is scrubbed and combusted and then used in a boiler to provide heat; capacity is 7 MMBtu/hr. This system provides the majority of the heating needs for Dockside Green (peak loads met by natural gas backup boilers). Excess heat will be sold offsite to displace natural gas.

- **KOPF**

KOPF has one main installation that has been in operation since 2002 in Balingen, Germany; this plant produces about 230 kg-dry/hr (energy value estimated at 1.2 MW based on digested sludge). The KOPF process includes solar drying to reduce moisture content of the dewatered cake to 15%–30% and no additional feed material is required. The gasifier operates at about 900°C with preheated air at 400°C for fluidizing the bed. The gases are cooled to below 150°C, dried, and filtered to remove impurities; the cleaned gas is used in a gas engine for power and heat generation. The engine produces 70 kW of energy and 15 kW of this energy is used to operate the gasification process; approximately 140 kW of thermal energy is recovered for digester heating. Information from KOPF and WERF Energy and Resource Recovery from Sludge 2008. The KOPF process is shown in **Figure 3.20**.

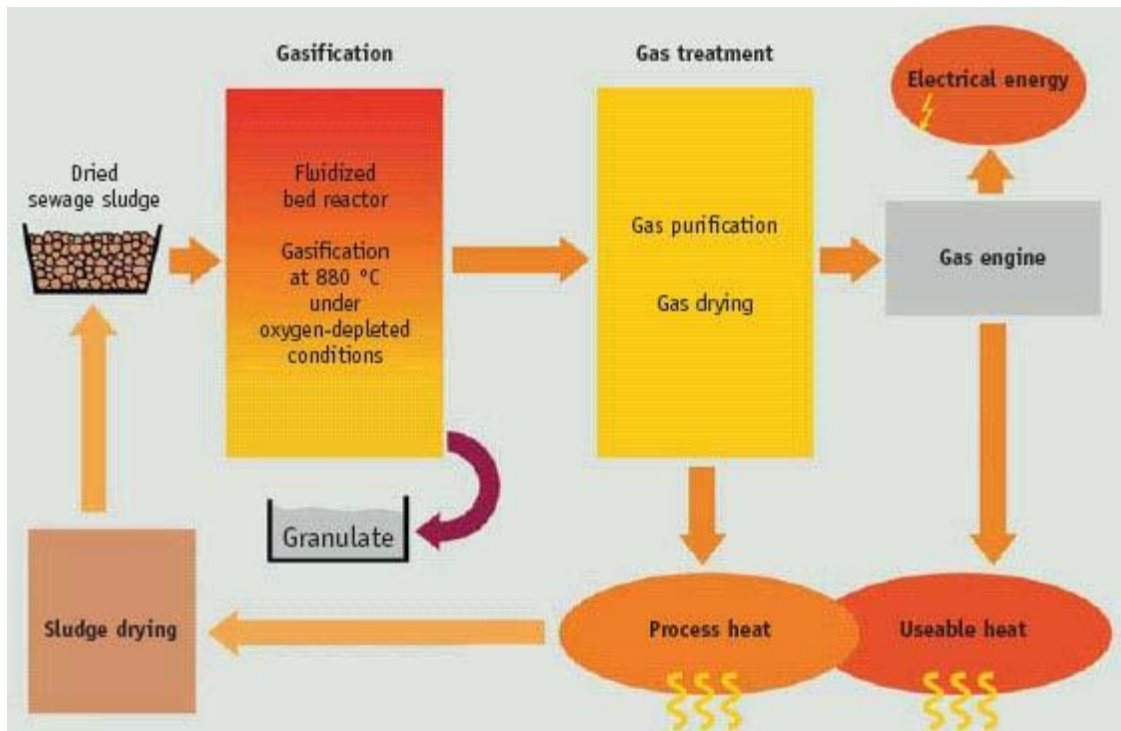

Figure 3.20 – KOPF Fluidized Bed Gasification System

3.2.5.3 Bio-Oil

Pyrolysis is a thermal conversion process similar to gasification, but is accomplished at lower temperatures and does not require the presence of oxygen. **Figure 3.21** shows a typical schematic of a pyrolysis process. The biomass feedstock or dried sludge pellets (5%–10% moisture content) are ground into a powder and heated in an inert atmosphere to temperatures between 400°C to 600°C (750°F to 1,100°F). The products of the pyrolysis process are a condensed liquid fuel (bio-oil), a gas mixture (syngas), and a solid residual (char). Modifying the temperature and rate of heating determines the amount and the energy content of the three products. The main purpose of the pyrolysis (compared to gasification) is a liquid fuel product because liquid fuel is easily transported and stored. The cooling and condensation of the syngas is done in a spray chamber followed by an oil-water separator.

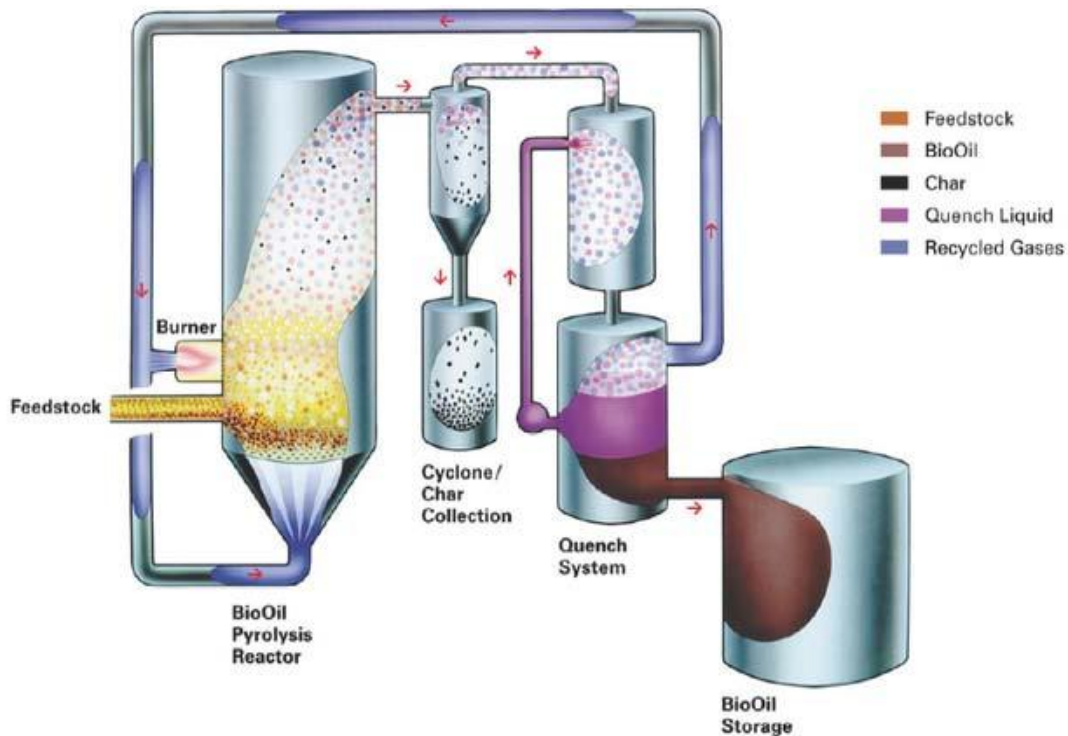

Figure 3.21 – Typical Pyrolysis Process

The pyrolysis process has technical difficulties ranging from an inability to scale up to large-scale production, relatively poor heat transfer, and dilution of the final product. In addition to process issues, the bio-oil requires further conditioning before it can be used as a fuel source. The conditioning is required to reduce water content, increase pH, reduce viscosity, reduce tar, and deoxygenate. Typically, 60% to 75% of the biomass can be converted to a crude bio-oil; further processing in a refinery to produce a useful fuel or transportation oil can recover around 40% of the crude bio-oil. In many cases, this bio-oil conditioning process proves to be the most difficult in developing an economically viable bio-oil product. Additionally, there are very few examples of pyrolysis using or including municipal biosolids.

Example Program: EnerSludge

Environmental Solutions International developed the first commercial application of the pyrolysis process for biosolids called EnerSludge in Perth, Australia. The plant was discontinued after 16 months of trial operations due to poor cost-effectiveness and the poor quality of bio-oil (intended as a diesel engine fuel).

3.2.5.4 Solid Fuel

Instead of gasifying the volatile material, the solid fuel producers retain the volatile compounds in the solid product through drying. The drying process can be any of the dryers typically used for biosolids drying, such as rotary drum, belt, paddle, MHF, FBI, etc. Any biosolids drying process will produce a dried product that can be used as a fuel source. However, the shape, size, and other characteristics may determine the product's ultimate suitability as a fuel source. The dried products typically have a heating value similar to a low-grade coal of about 6,000 to 8,000 Btu/lb (14 to 18.5 MJ/kg). The dried pellets can often be used as a replacement for coal in coal-fired power plants and any processes that use coal as the fuel or heat source (see also discussion of cement kilns in Section 3.2.3). The dried fuel can also be used in the WTE, gasification, and bio-oil systems described above.

Example Program: SlurryCarb

The SlurryCarb process uses dewatered cake to create dried pellets with low moisture content, typically 3%–10%. The general process is shown in **Figure 3.22**. The dewatered cake is placed under high pressure above its saturated steam pressure to maintain a liquid state throughout processing. The biosolids are then heated; because of the high pressure, no evaporation occurs. In the reactor vessel at the elevated pressure and temperature, “cellular structure of the biosolids ruptures and CO₂ gas splits off, a step called decarboxylation.” This process releases water that is typically bound up in the particles within the cellular walls. The resulting slurry is further dewatered in a centrifuge to approximately 50% solids and then dried in a rotary drum dryer. According to EnerTech, the SlurryCarb process uses two-thirds less energy than drying alone. EnerTech is currently operating four facilities including one in Rialto, California, and a demonstration project in Atlanta, Georgia.

The Rialto installation uses one dryer and two conditioning systems (from slurry pumps to centrifuges). The facility takes dewatered cake at 27.8%. The total mass feed to the system is 7,116 kg-dry/hr with an energy content of 35.6 MW (based on digested sludge at 18 MJ/kg). After the process, 6,540 kg-dry/hr or 92% of the biosolids remain and can be used as a solids fuel; 32.7 MW remains in the dried pellets or E-fuel (assumes no volatilization during the process). The natural gas energy input to the dryer, RTO, and hot oil is 11.1 MW; the electrical demand is 2.1 MW. An energy comparison of the SlurryCarb facility at Rialto to other selected WTE and thermal processing systems is provided in **Table 3.7**.

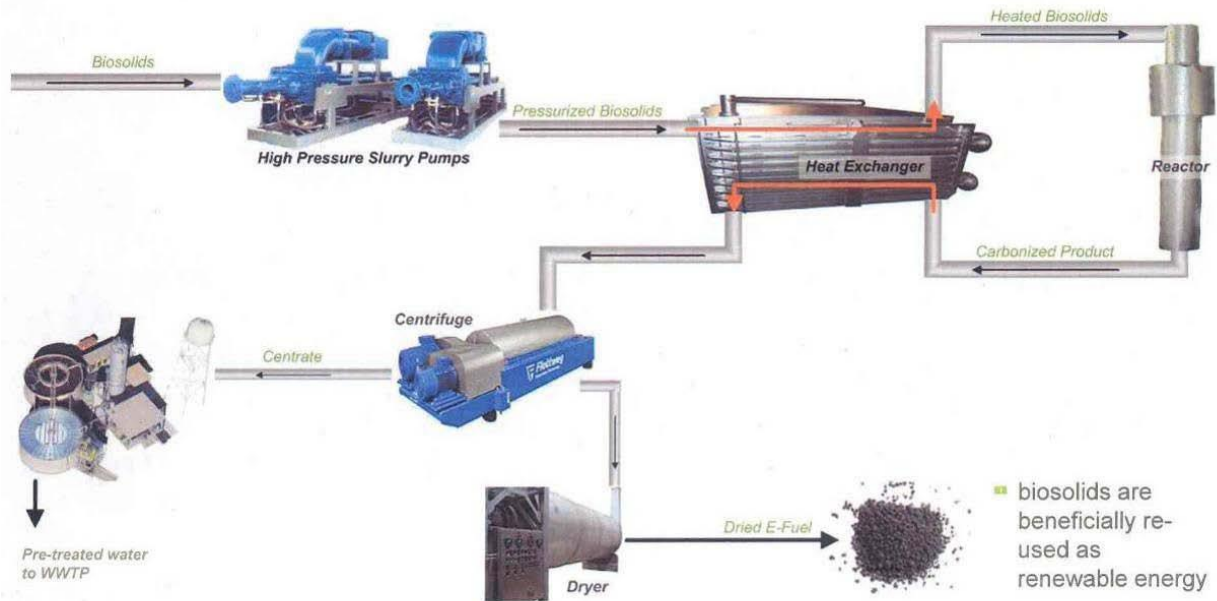

Figure 3.22 – SlurryCarb Process

3.2.6 Comparison of Processes

Table 3.7 summarizes the energy information from select WTE and thermal processes to convert biosolids to fuel.

CAPITAL REGIONAL DISTRICT

Core Area Wastewater Treatment Program

Assessment of Wastewater Treatment: Options 1A, 1B, and 1C

Table 3.7 – Reported Energy Balances for WTE and Thermal Processing Technologies

Option	Energy Input (MW)			Energy Output (MW)		Conversion Efficiency	
	Biosolids	MSW or NG	Power	Power	Steam	Electrical	System
WTE: fluidized bed: <i>biosolids and MSW</i> <i>Cedar Rapids</i>	21.5	58.6	1.2	13.5	49.9	15.4%	78.0%
WTE: fluidized bed: <i>biosolids only</i> <i>St. Paul MCES</i>	46.3	-	1.7	3.5	2.8	3.9%	13.2%
Gasification of biosolids <i>KOPF</i>	1.2	-	0.015	0.07	0.14	5.8%	17.3%
Solids Fuel <i>SlurryCarb and drying with NG</i>	35.6	11.1	2.1	32.7 ¹		-	67.1% ²

Notes:

1. Energy value in the dried biosolids.
2. Percent of energy available in the dried biosolids compared to all energy input.

3.2.6.1 Regulations (Air Emissions)

An overview of the monitoring requirements is included in Section 2.

3.2.6.2 Transportation: Hauling

After gasification or pyrolysis of biosolids, an ash or char product remains. The volume/mass is reduced similar to the process described in Section 3.2.5.2. The solid fuel generation through a drying process produces a dried product that is 25% the weight of the original dewatered cake and can be transported to a cement kiln as fuel substitute.

3.3 BACKUP DISPOSAL ALTERNATIVES

In Section 2 of this BMP the concept of “backup” and “primary” alternatives is discussed. For end-use reliability, a backup alternative must be a component of the final comprehensive management plan. A backup alternative must be fully within the direct control of the CRD and stand ready to receive all biosolids generated. If another primary alternative or group of alternatives for beneficial use is the main utilization method, no biosolids may ever actually be sent to the backup alternative. In this case it is acting as a backup in the event that a technical issue arises or markets for the primary alternative dissolve.

CAPITAL REGIONAL DISTRICT

Core Area Wastewater Treatment Program

Assessment of Wastewater Treatment: Options 1A, 1B, and 1C

A backup alternative is required for biosolids to ensure that CRD has a reliable disposal method available under its own complete control. The backup alternative may be more expensive than other utilization methods and achieve a lower benefit for GHG reduction and resource potential. Whether the backup alternative is selected for implementation or kept in reserve, it will be recognized as both reliable and available when needed.

Whereas the alternative descriptions above all have a beneficial use component, there are options for pure disposal that may function as a backup option for the CRD. In addition, some of the beneficial use alternatives discussed above have the inherent traits of a backup alternative and would function in both the backup and primary roles.

The following section discusses alternatives that can function as a backup alternative, whether it is purely a disposal option or is also a beneficial use option. It should be remembered that any final comprehensive biosolids management strategy, to ensure end-use reliability, must have one of these alternatives in its management portfolio.

3.3.1 Landfilling

Landfilling is a backup or contingency biosolids disposal option, to be used in the short term. The CRD owns and operates the Hartland landfill, approximately 14.3 km northwest of Victoria. Hartland services about 340,000 people and receives about 140,000 tonnes of MSW per year. Hartland is a multi-purpose facility that collects recycling, household hazardous waste, salvageable items, and yard and garden waste. The landfill provides service to commercial and residential customers. The current projected service life of the Hartland landfill is 35 years. However, its life will be extended once the organics diversion program is expanded. This could be further extended if the CRD looks at alternative means of solid waste disposal such as WTE. The CRD has an organic waste diversion goal of 60% by 2012 and 85% by 2020 (CRD, 2009). The landfill has partnered with the Maxim Power Corporation to co-operate a landfill gas utilization facility which produces 650 scfm (18 m³/min) of landfill gas (CRD, 2005).



Figure 3.23 – Overview of Landfill Area (left) and Gas Utilization Facility and Leachate Collection Ponds (right)

(source: CRD, 2009)

CAPITAL REGIONAL DISTRICT

Core Area Wastewater Treatment Program

Assessment of Wastewater Treatment: Options 1A, 1B, and 1C

3.3.2 Waste-to-Energy

WTE is discussed in detail in Section 3.2.4. In the context of the CRD program, it involves co-combustion with MSW in a regional facility owned and operated by the entity generating biosolids (e.g., the CRD and possibly others). Subsequently, the facility would not be subject to changes in private markets. A separate study by the CRD is in progress to evaluate the cost and feasibility of operating a solid waste WTE facility under tri-regional operation with regional cooperation between the CRD, Regional District of Nanaimo (RDN), and the CVRD. This WTE alternative could be considered both a beneficial use alternative (generating electricity and heat from biosolids) and a backup alternative (under the control of the CRD).

3.3.3 Incineration

Incineration is a thermal oxidation or combustion process in which the organic matter or VF is destroyed at high temperatures and in the presence of oxygen. Incineration of biosolids is typically accomplished using an FBI or an MHF as described in Section 3.2.4. Incineration is an energy consumer—all the energy going into the biosolids is burned and converted to hot gases, which are exhausted through the stack. As indicated in the hypothetical examples for CRD, auxiliary heat is required when combusting digested, dewatered biosolids. All the energy in the digested biosolids is therefore lost. However, when incinerating raw, dewatered biosolids, excess energy is available. Incineration of dewatered cake is typically a method for biosolids management by creating a small-volume, inert material for disposal or landfilling.

Incineration typically provides an alternative to landfill disposal of MSW without the benefit of energy recovery. Many existing facilities were designed this way prior to the era of high energy prices and sustainability considerations. It is unlikely that an incineration facility will be considered for this project because of the need for major capital investment without the opportunity for resource recovery.

3.3.4 Dedicated Land Utilization

The OMRR effectively prevents repeated, long-term application of biosolids to the same site due to stringent soil metals limits (as calculated earlier). However, one-time or limited applications using biosolids are feasible. To qualify fully as a backup option, the application site would need to be owned and operated by CRD. A site would be purchased for this purpose and conceivably be managed as forest land. The site would need to be accessible for hauling equipment and level enough for biosolids application. Application areas would need to meet all environmental suitability criteria including drainage and setbacks from surface water or other sensitive features. This concept is consistent with the biomass production example described in Section 3.2.1.

CAPITAL REGIONAL DISTRICT

Core Area Wastewater Treatment Program

Assessment of Wastewater Treatment: Options 1A, 1B, and 1C

3.3.5 Dedicated Land Disposal (DLD)

Application of biosolids at high rates for disposal on dedicated land is practiced at a few wastewater treatment facilities in North America. Typically, solids are injected into the soil where they are stabilized and assimilated. With this practice, the objective is economical disposal of solids rather than utilization for crop production or soil improvement. Example facilities are located in Colorado Springs, Colorado, and Sacramento, California. At the Sacramento facility, DLD units have been reconstructed with subsurface impermeable liner and under-drain systems in response to concerns about the potential for groundwater contamination. Environmental concerns make it unlikely that dedicated land disposal will be considered for the CRD.

3.4 PASS/FAIL CRITERIA AND SELECTION OF CANDIDATE ALTERNATIVES

3.4.1 Biosolids Management Objectives and Pass/Fail Criteria

In Section 2 of this BMP, the major objectives of the CRD biosolids management program were discussed. A successful comprehensive management program will address all of these objectives. However, any single ultimate disposal/utilization alternative may not meet all objectives. Instead, a blend of alternatives can be used to meet all objectives. Alternatives will be selected that achieve the following objectives:

- Potential to utilize or dispose of the biosolids loads through 2030
- Technologies support the ultimate utilization/disposal
- Implementation on required schedule (2016)
- Provides maximum resource recovery
- Reduces GHG emissions
- Integrates with solid waste management
- Provides end-use reliability: primary and backup alternatives
- Technologies that can be constructed at a reasonable cost and have an acceptable operating and life-cycle cost
- Provides process reliability: proven technology
- Meets all regulatory requirements.

Some of these objectives are appropriately relevant to the end-use/disposal alternatives, some to backup alternatives, whereas some are more specifically relevant to the technology or hardware used for preparing the biosolids for end-use. These objectives are discussed in the context of pass/fail criteria in the following sections.

CAPITAL REGIONAL DISTRICT

Core Area Wastewater Treatment Program

Assessment of Wastewater Treatment: Options 1A, 1B, and 1C

3.4.2 Backup Alternative Screening

The first step in the alternative selection process is to identify the viable backup alternatives. These alternatives have to meet the following pass/fail criteria:

P/F Criterion 1: Can dispose of the entire biosolids load

P/F Criterion 2: Is completely under the control of the CRD to provide end-use reliability

P/F Criterion 3: Is or can be fully operational by 2016.

Alternatives discussed in Section 3.3 are those with the potential to meet these three criteria and provide backup reliability to the system. Of the list, only landfilling makes sense as a backup alternative for the CRD. The CRD currently operates the Hartland landfill which at current rates has at least a 35-year life remaining. With planned recycling programs, this could be extended further. No additional investment would be required to provide this backup alternative although further investigation of the biocell concept and possible pilot studies are recommended

Currently, the CRD is studying the potential for developing a regional WTE facility for residual solid waste remaining after recycling. A likely candidate site for this facility would be the Hartland landfill site. If this facility were built, use of dewatered or dried biosolids in this facility could be a reliable backup alternative. However, with preliminary feasibility studies just now beginning, it is not reasonable to expect that this facility could be operational by 2016.

Dedicated land disposal or utilization in which the CRD would purchase land for all of the biosolids would require extensive effort. It is unlikely that a separate site could be found and environmental issues satisfactorily addressed for either of these alternatives within the time frame of this project.

Incineration meets the criteria described but overlaps with WTE, an alternative which has more significant environmental benefits and resource recovery potential. WTE is considered further as a primary alternative below. For these reasons and because the CRD already has a backup alternative, only landfilling at Hartland landfill is considered viable and considered further as a backup alternative. It should be noted, however, that landfilling does not meet the objectives of primary biosolids management alternatives and therefore is considered only as a backup option. Primary alternatives for beneficial use of biosolids are discussed in the next section.

CAPITAL REGIONAL DISTRICT

Core Area Wastewater Treatment Program

Assessment of Wastewater Treatment: Options 1A, 1B, and 1C

3.4.3 Primary Alternative Screening

The next step in the alternative selection process is to identify the viable primary utilization alternatives. These alternatives have to meet the following pass/fail criteria:

P/F Criterion 3: Promotes maximizing resource recovery

P/F Criterion 4: Reduces GHG emissions

P/F Criterion 5: Promotes integration with solid waste

P/F Criterion 6: Uses proven technology.

Table 3.8 summarizes the primary alternative pass/fail screening criteria for each alternative candidate.

Table 3.8 – Primary Alternative Pass/Fail Screening Summary

P/F Criterion No.	3	4	5	6
Primary Alternative Candidates	Promotes Maximum Resource Recovery	Reduces GHG Emissions	Promotes Integration with Solid Waste	Uses Proven Technology
Dried fertilizer product	Pass	Pass	Pass	Pass
Top soil blend	Pass	Pass	Pass	Pass
Land application	Pass	Pass	Pass	Pass
Mine reclamation	Pass	Pass	Pass	Pass
Lime-pasteurized product	Fail	Fail	Fail	Pass
Biomass production	Pass	Pass	Pass	Pass
Compost product: raw biosolids	Fail	Pass	Pass	Pass
Compost product: digested biosolids	Pass	Pass	Pass	Pass
Biocells	Pass	Pass	Pass	Fail
Cement kiln fuel	Pass	Pass	Pass	Pass
WTE fuel	Pass	Pass	Pass	Pass
Thermal processing to gas or solid fuel	Pass	Pass	Fail	Fail

CAPITAL REGIONAL DISTRICT

Core Area Wastewater Treatment Program

Assessment of Wastewater Treatment: Options 1A, 1B, and 1C

Alternatives screened from further consideration are those with “Fail” designations in **Table 3.8**. Further explanation of those failing designations is described below:

- **Lime pasteurization** – No opportunity to recover energy value as gas or fuel, lime and additional mass trucking adds significantly to GHG emissions, no opportunity for co-digestion or biogas generation.
- **Compost product/raw biosolids** – No opportunity for digestion with gas generation and use, which will be a major contributor to alternative benefit.
- **Biocells** – Although they show promise, no long-term operation has yet proven methane capture during filling and covering and transition to aerobic phase. Even a small release of methane (1 molecule of methane has 23 times the GHG potential as 1 molecule of CO₂) can eliminate the GHG benefit from gas capture and use. Biocells may be a candidate for pilot testing at Hartland landfill to prove out methane capture through all phases of operation and successful recovery of end products after the aerated phase. The biocell does offer advantages over the current CRD practice of landfill of biosolids.
- **Thermal processing** – Possible integration if wood waste is used with a processor for fuel production. Not yet proven at full scale for biosolids in North America.

Those alternatives that pass all criteria in **Table 3.8** are retained for further evaluation in subsequent sections of the BMP.

3.5 REFERENCES

CRD. 2005. Hartland Landfill Gas Utilization Project: 2005 UBCM Community Excellence Award. Capital Regional District.

CRD. 2009a. Solid Waste Management Presentation. Capital Regional District.

CRD. 2009b. Residential Organics Collection Pilot Final Report Summary. Capital Regional District.

Dimitriou and Aronsson, 2005. Willows for energy and phytoremediation in Sweden. Unasyilva 221, Vol 56:47–50.

GVRD, 2003. Nutrifor Program Annual Report 2003. Greater Vancouver Regional District.

Larsson S and Lindegaard K. 2003. Full Scale Implementation of short rotation willow coppice SRC, in Sweden. Agrobransle.
http://www.shortrotationcrops.org/PDFs/IEA_Larsson&Lindegaard.pdf

Metcalf & Eddy. 2002. Wastewater Engineering: Treatment and Reuse. 4th Edition.

CAPITAL REGIONAL DISTRICT

Core Area Wastewater Treatment Program

Assessment of Wastewater Treatment: Options 1A, 1B, and 1C

MABC, 2008. Operating Mines and Proposed Mine Developments in British Columbia. Mining Association of British Columbia.

NOAMI, 2009. National Orphaned/Abandoned Mines Initiative 2002–2008 Performance Report. <http://www.abandoned-mines.org/home-e.htm>

Otoski, 1981. Lime Stabilization and Ultimate Disposal of Municipal Wastewater Sludges. U.S. EPA Research and Development.

Rolston G. 2007. Land Application of Biosolids: Report on 2007 land application of biosolids at the Norm Wood Environmental Centre. City of Campbell River.

Spellman, F.R. 1997. Wastewater biosolids to compost. Publisher CRC Press, ISBN1566764610.

Stantec, 2006. Sustainable Landfill Bio-Cell. City of Calgary-Waste & Recycling Services.

Sylvis, 2008. Capital Regional District- Biosolids Market Assessment.

Vande Walle, I., Van Camp, N., Van de Castele, L., Verheyen, K., Lemeur, R. 2007. Short-rotation forestry of birch, maple, poplar and willow in Flanders (Belgium) 11. Energy production and CO2 emission reduction potential. Biomass & Bioenergy. Vol. 31: 276–283.

Van Ham M.D., Hutchison J.S., Dampier L.M.B., Vieira D.B. A regional approach to biosolids management: The Sechelt experience. Sylvis Environmental.

Werther J. and Ogada T., 1999. Sewage Sludge Combustion. Progress in Energy and Combustion Science 25: 55–116.

Section 4 Biosolids and Municipal Solid Waste Integration Options

Recognizing potential synergies between the resource recovery and disposal needs of biosolids and municipal solid wastes (MSW), the CRD has adopted the goal of integrating biosolids management with the existing MSW program to the extent practical and beneficial. There are several opportunities for accomplishing this, ranging from direct disposal of biosolids in the landfill, co-digestion of suitable source separated organic wastes with biosolids, co-combustion in a WTE facility, and co-composting. In the previous section, alternatives for processing, beneficial use, and disposal of biosolids were discussed. This section describes how these alternatives can be integrated with the MSW program. Details of the integration alternatives are described in this section along with considerations of siting of biosolids facilities with solid waste facilities.

4.1 CO-LANDFILLING WITH ORGANIC SOLID WASTE IN A HARTLAND LANDFILL BIOCELL(S) TO ENHANCE GAS PRODUCTION

Direct landfilling of biosolids at Hartland landfill meets the CRD's needs as a backup alternative, but not as a primary alternative, as this biosolids disposal method does not meet the objectives for resource recovery and GHG reduction described in Section 2. Further, landfilling is not consistent with mandated CRD goals for diversion of organics from MSW.

Modification of landfill design to include the "biocell" concept would, however, potentially meet these goals. The biocell concept, described in Section 3.2.2, has the goal of producing useable landfill gas (methane) and a useable soil amendment compost product. Converting a portion of the Hartland landfill to a biocell design, perhaps on a demonstration scale, may be considered in the future. Biosolids would benefit biocell operation by adding nutrients and anaerobic microorganisms to the system that would enhance the rate and extent of anaerobic decomposition of solid waste organics to methane. If successful, the biocell concept could extend the life of the landfill and reduce GHG emissions from the landfill operation, while at the same time producing useable products. Other encapsulation design modifications to the current landfill can also be considered, but the biocell concept is suggested as an example.

An 80,000-tonne-capacity biocell has been in successful operation in the anaerobic phase in Calgary for the past 2 years, producing substantial quantities of methane, sufficient to generate about 300 kW of power on a continuous basis. However, the technology, including the Calgary operation, is not yet proven with regard to its transition to late-stage aeration, final harvesting of compost product, and revenue assumptions. The concept did not pass primary alternative screening as described in Section 3.4 because of the need to first prove the technology at all phases of operation. However, it is recommended for consideration on a demonstration scale, considering the potential benefits. The design cycle time for a biocell is 4 years in the anaerobic

phase and 4 years in an aerobic phase. If started today, a demonstration test would not be completed in time for the 2016 planned startup of the new wastewater treatment facilities. The current practice of landfilling is in essence similar to a biocell but without the liners and air injection system. These additional components can be added quite cost-effectively. For reference purposes the Calgary biocell was constructed for \$3 million. Therefore, planning for other integration alternatives should continue. However, biocells, once proven, may represent a valuable tool for CRD to recover energy from organic solid waste as well as enable reuse of the treated organics for compost or soil amendment.

An 80,000-tonne biocell, similar in size to that constructed in Calgary, would be charged with approximately 40,000 tonnes of organic solid waste (yard and food waste) at about 50% solids concentration and 40,000 tonnes of dewatered, digested biosolids cake at about 25% solids concentration. Since the CRD wastewater facilities will produce only about 22,000 tonnes per year of dewatered, digested biosolids cake, the biocells would have to be much smaller than this to assure a reasonable time to fill and cap the biocell before methane release becomes a major concern. A 1-month fill period would be advisable, resulting in biocell sizes of approximately 4000 tonnes.

4.2 CO-DIGESTION WITH FOG, SOURCE SEPARATED FOOD WASTE, OR OTHER FOOD PRODUCTION WASTE PRODUCTS

The addition of anaerobic digesters to the CRD wastewater treatment facilities for stabilizing wastewater biosolids would open opportunities for the CRD to generate renewable energy and reduce its carbon footprint by co-digesting suitable food wastes and potentially other organics with the wastewater biosolids. Examples of common substrates include pulped food scraps; fats, oils, and grease (FOG); and other industrial food processing wastes. Substrates commonly added during co-digestion typically exhibit desirable characteristics for generating additional gas and low solids production relative to biosolids alone. The opportunity exists to size CRD digestion facilities to accommodate the addition of co-digestion substrates.

The capacity to add co-digestion substrates to the digesters at CRD's wastewater facilities not only generates renewable energy but also supports CRD's landfill capacity conservation efforts. The CRD has a proposed ban date of May 2012 for organics to the landfill. The current Solid Waste Strategic Plan has a short-term goal of 60% by 2013 and 90% diversion by 2020. **Table 4.1** summarizes estimates of some common co-digestion substrates in the region using population based parameters from a variety of studies.

CAPITAL REGIONAL DISTRICT

Core Area Wastewater Treatment Program

Biosolids Management Plan

Table 4.1 – Estimates of the Quantities of Common Co-Digestion Substrates in the Capital Region District from Population-based Parameters from Various Sources

	Value	Units	Notes/Assumptions
Metro Vancouver Solid Waste Characterization Study			
Commercial food waste	1,838	tonnes-TS/year	50% capture, 11% solids
Residential food waste	1,084	tonnes-TS/year	50% capture, 11% solids
Total food waste	2,923	tonnes-TS/year	50% capture, 11% solids
Capital Region District Waste Characterization Study			
Commercial food waste	N/A	tonnes/year	
Residential food waste	N/A	tonnes/year	
Total food waste	3,435	tonnes/year	50% capture, 11% solids
Fats, Oils, and Grease (Wiltsee [1998])			
Brown grease	5,992	tonnes-TS/year	100% capture, 6.08 kg-TS/person-yr
Yellow grease	3,926	tonnes-TS/year	
Total fats, oils, and grease	9,918	tonnes-TS/year	

The variety in the substrates listed and the potential for food processing wastes in the region makes it difficult to make an estimate of actual collected substrates at this time. Therefore, the methodology used to size the digesters to accommodate co-digestion was to provide 10% additional volume beyond that which is required to maintain a 15-day HRT at peak 14-day flows and loads of sludge, resulting in the Upper Victoria Harbour facility having four digesters of 4,100 m³ in volume and West Shore two digesters of 2,700 m³. This approach was used, rather than identification of the total number of available substrates in the region, as such a market assessment effort would be beyond the scope of the planning effort and the data would have limited value once the facility is constructed, due to its age. It should be noted that biogas and biosolids production from co-digestion substrate addition is not proportional to the added volume, because co-digestion substrates typically have higher methane potentials and greater degradability.

Table 4.2 summarizes the raw sludge loads and FOG loads to each of the proposed facilities along with the projected contributions to biosolids production. Table 4.3 summarizes the biogas generation from each facility as a result of accepting the maximum FOG load under 2030 average annual conditions.

CAPITAL REGIONAL DISTRICT

Core Area Wastewater Treatment Program
Biosolids Management Plan

Table 4.2 – Summary of Solids Loading to Anaerobic Digesters under Average Annual Conditions for CRD Facilities

	Upper Victoria Harbour Facility	West Shore Facility	Units
Raw Sludge Characteristics			
Load	23,430	5,739	kg-TS/day
Flow	469	115	m ³ /day
Concentration	0.05	0.05	kg-TS/kg-sludge
Volatile fraction	0.82	0.82	kg-VS/kg-TS
Brown Grease Solids			
Load	4,738	1,184	kg-TS/day
Flow	43	11	m ³ /day
Concentration	0.1	0.1	kg-TS/kg-sludge
Volatile fraction	0.95	0.95	kg-VS/kg-TS
Yellow Grease Solids			
Load	1,329	302	kg-TS/day
Flow	12	3	m ³ /day
Concentration	0.1	0.1	kg-TS/kg-sludge
Volatile fraction	0.95	0.95	kg-VS/kg-TS
Total Raw Solids and FOG Load to the Digesters			
Load	29,497	785	kg-TS/day
Flow	524	129	m ³ /day
Concentration	0.1	0.1	kg-TS/kg-sludge
Volatile fraction	0.85	0.85	kg-VS/kg-TS
Total Combined Liquid Biosolids Generation			
Load	12,686	3,107	kg-TS/day
Flow	513	126	m ³ /day
Concentration	0.025	0.025	kg-TS/kg-sludge
Volatile fraction	0.644	0.644	kg-VS/kg-TS

Notes:

1. Assumes 80% of flows and loads to McLoughlin Point facility and 20% to West Shore Facility.
2. Assumes brown grease will be captured up to 100% of the available material in region prior to the capture of the total potential yellow grease in the region, due to the commodity value of yellow grease.
3. The maximum fraction of the volatile load of FOG is maintained at or below 30% to provide stable digestion conditions.
4. Source of FOG production values from National Renewable Energy Laboratories (U.S.) National Grease Resource Assessment authored by Wiltsee (1998) for all alternatives (yellow grease: 4.03 kg-YG/person-year, brown grease: 6.08 kg-BG/person-year).
5. Assumed FOG waste was: TS = 10%, VF = 95%, volatile solids reduction (VSr) = 85%, biogas yield (Y_{biogas}) = 1.23 m³/kg-VSr.
6. Assumed sewage sludge was: TS = 5%, VF = 82%, VSr = 60%, Y_{biogas} = 0.936 m³/kg-VSr.
7. Assumes an additional 2% of sludge VSr when FOG is added to account for potential synergistic effects.
8. Assumes specific gravity of substrates equivalent to water, which is conservative when estimating flows.
9. Assumed a population of 355,772 people for 2030 based on Population Projections for Calculations.xls from Stantec.

CAPITAL REGIONAL DISTRICT

Core Area Wastewater Treatment Program

Biosolids Management Plan

Table 4.3 – Summary of Biogas and Methane Production to Anaerobic Digesters under Average Annual Condition for CRD Facilities with Co-digestion

Biogas Production	Upper Victoria Harbour Facility	West Shore Facility	Units
Wastewater Solids			
Total biogas	10,790	2,643	m ³ -biogas/day
Methane fraction	0.583	0.583	m ³ -CH ₄ /m ³ -biogas
Total methane	6290	1541	m ³ -CH ₄ /day
Brown Grease			
Total biogas	4,760	1,176	m ³ -biogas/day
Methane fraction	0.583	0.583	m ³ -CH ₄ /m ³ -biogas
Total methane	2734	686	m ³ -CH ₄ /day
Yellow Grease			
Total biogas	1,320	300	m ³ -biogas/day
Methane fraction	0.583	0.583	m ³ -CH ₄ /m ³ -biogas
Total methane	770	175	m ³ -CH ₄ /day
Total			
Total biogas	16,870	4,119	m ³ -biogas/day
Methane fraction	0.583	0.583	m ³ -CH ₄ /m ³ -biogas
Total methane	9794	2402	m ³ -CH ₄ /day

Notes:

1. Assumes 100% capture of brown grease with the remaining capacity consumed by yellow grease.
2. Assumes that minimum digester volume must maintain an HRT of 15 days, based on influent flows.
3. The fraction of the volatile load of FOG should be maintained below 30% to provide stable digestion conditions.
4. Assumed FOG waste was: TS = 10%, VF = 95%, VSr = 85%, Y_{biogas} = 1.23 m³/kg-VSr.
5. Assumed sewage sludge was: TS = 5%, VF = 82%, VSr = 60%, Y_{biogas} = 0.936 m³/kg-VSr.
6. Assumes an additional 2% of sludge VSr when FOG is added to account for potential synergistic effects.

It should be noted that FOG was selected as the representative substrate for co-digestion as it provides some unique process characteristics which serve to provide conservative high estimates of gas production. Fats, as noted by Li et al. (2002), have the highest theoretical methane potential of substrate components, fats, proteins, and carbohydrates. Furthermore, others have reported that FOG enhances the destruction of wastewater solids in digesters though a synergistic effect further enhancing gas production.

If CRD chooses to execute a co-digestion program there may be additional infrastructure requirements including thickening equipment or food waste processing facilities, depending on the substrates accepted. The base-case condition would be a hauled liquid waste receiving facility, with at a minimum a rock trap, screening, and process heating sufficient to receive and

process FOG. Deviation from the base conditions will be an added cost but also potentially provide added revenue from tipping fees and avoided energy costs, through additional gas and potentially reduced GHG emissions.

It is assumed that if food waste is co-digested, a food waste pre-processing facility that removes non-organic foreign debris and pulps the product to a form that can be pumped, capable of feeding to the digesters, would be located remote from the biosolids processing facility. A reasonable assumption for this location would be the Hartland landfill where the food waste can be easily collected.

One additional consideration is the practicality of building a separate food waste digester to keep these solids separate from the wastewater biosolids which have a sanitary significance. Despite potential perception issues, this is not recommended because separate food waste digestion would eliminate the biological process synergies from digestion with biosolids, reduce overall gas production, and increase costs of this process substantially. Digested wastewater biosolids are assumed to be processed through a Class A thermophilic digestion process that is designed and regulated to kill pathogens and make the product suitable for unrestricted public use.

4.3 CO-COMPOSTING WITH YARD AND FOOD WASTE TO PRODUCE SOIL AMENDMENT PRODUCT FOR DISTRIBUTION

Yard and food waste are commonly composted together to produce a marketable compost product. This is often done using an enclosed vessel system for process control. An example is the system at Whistler, BC. Yard and food waste are very high in carbon, but may benefit from additional amendments of nitrogen in biosolids to achieve a proper C:N ratio. This approach to composting has been suggested as one way to integrate solid waste management with biosolids. The product could be used for soil improvement projects such as re-vegetation of highway medians, reclamation, or city landscaping. Uses of the product would be limited compared with “pure organics” compost. By mixing yard waste and food waste with biosolids, the product would have to meet OMRR requirements, an additional stringent regulation that monitors production and application of biosolids products. This regulation is discussed in 2.2.7.

4.4 WASTE-TO-ENERGY FACILITY WITH BIOSOLIDS AND SOLID WASTE

The benefits of a WTE facility for the CRD include the potential to extend the life of the Hartland landfill and to capitalize on the green energy value of biosolids. According to the CRD, the Hartland landfill has another 35 to 40 years of capacity (assuming disposal of waste generated within CRD only). Planned increases in source separation of the organics will extend the life of the landfill substantially if projections are realized. Consequently, there is no urgent pressure on the CRD to move to WTE. The neighbouring region of Cowichan Valley has zero capacity in its landfill and subsequently has been shipping the waste to the U.S. New legislation will prevent the waste from leaving the district, forcing Cowichan Valley to identify an alternative disposal option. CRD could partner with the RDN and CVRD to fund the construction and operation of a

CAPITAL REGIONAL DISTRICT

Core Area Wastewater Treatment Program Biosolids Management Plan

regional WTE facility. By adding dried biosolids to the MSW, moisture of the material could be reduced and combustion of solids could help optimize the process by increasing the heating value of the combined fuels. A WTE facility is currently in operation in Burnaby, BC; see discussion in Section 3.2.4. A separate study for a regional WTE facility on Vancouver Island is in progress by the CRD.

Preliminary information indicates that the material stream that could be directed to an integrated MSW/biosolids WTE facility could consist of the following:

- Up to 100,000 annual tonnes (approximately 280 tonnes per day) of post-diversion residual waste from the CRD, consisting primarily of curbside residual wastes from residential households (assuming both recycling and source separated organic programs in effect);
- Up to an additional 100,000 annual tonnes (approximately 280 tonnes per day) of combined post-diversion residual waste from the CVRD and the RDN.
- An average of up to 29 tonnes per day of dry raw sludge (32 tonnes per day wet weight if dried to 90% solids content); or 15 tonnes per day of dry digested biosolids (17 tonnes per day wet weight if dried to 90% solids content).

Some WTE facilities such as mass burn plants, can accept up to a certain percentage of biosolids with lower solids contents (i.e. typical 28% dry solids), however, there is an upper limit of between 10 to 20% for the proportion of this material that can be accepted in the fuel mix without disrupting plant performance. Therefore for the purpose of examining integrated processing of biosolids and MSW it will be assumed that the biosolids will be thermally dried either at the WTE facility through use of waste heat or at the WWTP using effluent heat extracted from the effluent using high-efficiency heat pumps.

Currently, approximately 155,000 tonnes per year of waste is generated in the CRD and landfilled, indicating a waste generation rate in the CRD of approximately 440 kg/capita. This is relatively consistent with waste generation rates in other large regional jurisdictions. Currently, jurisdictions similar in size to CRD that have mature recycling and organics programs are diverting in the order of 42% of all waste generated (Waste Diversion Ontario, 2007). Additional efforts to increase diversion have been implemented or are being considered in order to achieve higher rates, including reduced frequency of waste collection, reducing collection to one bag per week and other measures. The CRD has a waste diversion goal of 60% by 2012 and 85% by 2020 (CRD, 2009).

It has been estimated that dried digested biosolids have approximately 18,000 kJ/kg energy potential, while dried undigested biosolids have a calorific value of approximately 22,000 kJ/kg.

The energy value of MSW varies, pending the composition of the residual waste stream and success in diverting wetter waste streams (food waste). Based on recent experience in post-diversion waste characterization, the energy content of the post-diversion MSW can be

CAPITAL REGIONAL DISTRICT

Core Area Wastewater Treatment Program
Biosolids Management Plan

expected to have an as-received energy content, on a higher heating value (HHV) basis, ranging from 11,000 kJ/kg to 15,000 kJ/kg (JWSL, GENIVAR, 2009). Other studies have indicated average heating values in the order of 13,000 to 14,000 kJ/kg for post-diversion MSW.

For the purpose of analyzing integrated MSW/biosolids WTE scenarios, an average heating value of 13,000 kJ/kg is a reasonable assumption.

Table 4.4 presents a summary of the flow of the materials through a WTE system, identifying the primary material streams recovered or disposed in mass burn systems managing a typical post-diversion MSW stream.

Table 4.4 – Potential Flow of Materials through WTE Facility

Material Stream	Estimated Annual Tonnes
MSW received: 100,000 tpy from CRD 70,000 tpy from Nanaimo 30,000 tpy from Cowichan Valley	200,000
CRD dried biosolids received (maximum, dried raw biosolids)	10,000
Rejects/materials disposed (2% of MSW rejected, 5% of total input landfilled during scheduled downtime)	18,700
Input to combustion unit	191,300
Metals recovered (10% of input tonnes, 80% of ferrous and 60% of non-ferrous metals present in the bottom ash)	18,100
Bottom ash landfilled if no aggregate recovered (21% of input tonnes)	40,200
Bottom ash landfilled if aggregate recovered (typical recovery 60% of dry ash, leaving 40% for disposal)	16,100
Moisture and mass loss through combustion	133,000
Fly ash to disposal (5% of input tonnes, primarily lime and carbon injected into the APC system)	9,600
Total disposed (no aggregate recovered from bottom ash) ¹	68,500
Total disposed in Landfill (aggregate recovered) ¹	44,400

Note:

1. Includes fly ash which may or may not be disposed of at the Hartland landfill, depending on whether the plant design includes treatment/stabilization.

CAPITAL REGIONAL DISTRICT

Core Area Wastewater Treatment Program
Biosolids Management Plan

The estimates of the materials that would be sent directly to landfill disposal from the plant, include materials rejected from the tipping floor and any materials that must be redirected to landfill during plant shut-downs.

In the materials entering the combustion unit, there is still considerable metals present, in the form of non-recycled metal cans and aluminum foil, household goods (mattresses etc.) which have metal components etc. WTE facilities use back-end processes to recover these metals from the bottom ash following combustion.

The quantity of bottom ash that requires landfill disposal will vary. It is common practice in other jurisdictions to recover a portion of the bottom ash for use as an aggregate material, but not as common in Canada.

Overall, the quantity of material requiring disposal from the WTE scenarios would be between 21 and 33% of the total tonnes entering the facility. However, the total volume of material requiring landfill disposal would be reduced to a greater extent, due to the much higher density of this material compared to regular MSW, and as noted below, this can have a profound effect on the waste disposal system in CRD.

Implementation of an integrated MSW/biosolids WTE facility could have a significant effect on the landfill disposal system within the CRD, due to the decrease in the total volume of materials that would require landfill disposal and the extension of the Hartland landfill life.

The 2008 annual report issued by the CRD waste management division indicates that in the order of 155,000 tpy of waste (not including special waste) was disposed in 2008. That same report indicated that the assumed lifespan of the Hartland landfill site was estimated as being approximately 40 years. The estimated diversion rate for 2008 was 37%. Based on the figures set out in the 2008 report, the current disposal rate is approximately 420 kg/capita. Should the CRD achieve higher diversion rates, in the order of 60% based on full implementation of source separated organics diversion programs in combination with more stringent regulatory measures, the disposal rate could be decreased to around 270 kg/capita, or approximately 100,000 tpy.

Table 4.5 provides an overview of the estimated annual landfill airspace consumption that would occur under the status quo disposal system compared to a system with an integrated WTE plant, where all of the plant residues are disposed in the Hartland landfill. On an annual basis, assuming that the per capita waste generation rate stays the same as present, a 200,000 tpy integrated WTE plant at Hartland could reduce the consumption of landfill capacity by approximately 75%. Over a 35-year period, between 6 million and 8.5 million cubic metres of landfill capacity would be required depending on whether 60% diversion is achieved. Over the same period 2 million cubic metres would be required under a 200,000-tpy integrated MSW/biosolids WTE scenario.

Table 4.5 – Comparison of Landfill Space Consumed under Existing and Potential WTE Alternatives

	Status Quo: MSW Disposal at Hartland	Integrated 200,000 tpy WTE Plant at Hartland
Annual tonnes disposed	155,000	59,000
Volume: airspace consumed (m ³) MSW density = 750 kg/m ³ Bottom ash density = 2,000 kg/m ³ WTE plant rejects = 600 kg/m ³	207,000	51,000
Volume of cover material (m ³)	35,000	9,000
Annual airspace consumed (m ³)	242,000	60,000

Note:

1. Assumes no aggregate recovery from bottom and does not include fly ash which may or may not be disposed at the Hartland landfill.

A WTE could extend the potential operating life of the Hartland landfill, well beyond 100 years. Such an extension has considerable value in that the CRD would have a longer period of disposal security.

4.5 BIOSOLIDS FACILITY SITING CONSIDERATIONS

From a biosolids treatment efficiency standpoint, the most beneficial location for constructing digestion, dewatering, drying, and gas treatment facilities is at the location of the liquid stream wastewater treatment plant. The preferred option for wastewater treatment is Option 1A which currently assumes a plant is located at McLoughlin Point and another on the West Shore. As previously discussed, there is insufficient room at McLoughlin Point for biosolids facilities. An assumption has been made that a separate biosolids site in the Upper Victoria Harbour would be developed. Further siting studies are currently being conducted to assess alternative sites large enough for combined liquid and solid stream facilities. For co-digestion at the WWTP, organic wastes would be trucked to the WWTP. Food waste would be cleaned and pulped at another location prior to being trucked to the WWTP.

An alternative would be to locate biosolids treatment facilities at Hartland landfill. This would require building a force main to pump liquid sludge to Hartland. By locating a digestion site at Hartland landfill, organic waste can be separated, pulped on site, and added to the digester with the biosolids. Availability of a natural gas line for sale of digester gas close to Hartland is as yet undetermined. Biogas may have to be used for process heat and to generate electrical power rather than conditioned for sale if the facilities are located at Hartland.

CAPITAL REGIONAL DISTRICT

Core Area Wastewater Treatment Program
Biosolids Management Plan

WTE facilities designed for both biosolids and MSW would have to be located at a site separate from the treatment plant as it would not be desirable to bring solid waste hauling trucks into the Victoria downtown core. For the purposes of this study, it is assumed the WTE facility would be located at Hartland landfill.

4.6 INTEGRATION ALTERNATIVES SCREENING

The next step in the alternative selection process is to identify the most viable solid waste integration alternatives. These alternatives have to meet the following pass/fail criteria:

P/F Criterion 4: Promotes maximizing resource recovery

P/F Criterion 5: Reduces GHG emissions

P/F Criterion 6: Promotes integration with solid waste

P/F Criterion 7: Uses proven technology.

Table 4.6 summarizes the pass/fail selection process for each integration alternative candidate.

Table 4.6 – Integration Alternative Pass/Fail Screening Summary

P/F Criterion No.	4	5	6	7
Integration Alternative Candidates	Promotes Maximum Resource Recovery	Reduces GHG Emissions	Promotes Integration with Solid Waste	Uses Proven Technology
Co-landfilling in biocell	Pass	Pass	Pass	Fail
Co-digestion	Pass	Pass	Pass	Pass
Co-composting	Fail	Pass	Pass	Pass
WTE	Pass	Pass	Pass	Pass

Co-landfilling in a biocell failed the screening process based on proven technology. As discussed above, this technology is proven through its anaerobic phase of operation, but as yet has not proven performance requirements through the aerobic and material harvesting phases. It is recommended that due to the potential for beneficial production of methane and a composted product, that biocells be demonstration scale pilot tested at Hartland.

CAPITAL REGIONAL DISTRICT

Core Area Wastewater Treatment Program
Biosolids Management Plan

Co-composting also failed due to public perception and concerns that reclassifying food waste or “pure organics” compost product would make it less marketable. Co-composting reduces opportunities for gas sale and carbon offset.

Co-digestion and WTE have passed the screening process and are considered further in this report. Depending on the location and phasing of facilities there could be an opportunity to consider co-digestion in combination with a first stage smaller scale WTE facility.

4.7 REFERENCES

CRD. 2009b. Residential Organics Collection Pilot Final Report Summary.

http://www.crd.bc.ca/waste/organics/documents/RESIDENTIAL_ORGANICS_COLLECTION_PILOT_-_FINAL_REPORT_SUMMARY.pdf

JWSL, GENIVAR, July 2009. Facility Energy and Life Cycle Assessment – Technical Study Report DURHAM YORK RESIDUAL WASTE EA STUDY

Li, Y.Y., H. Sasaki, K. Yamashita, K. Seki, I. Kamigochi. (2002) “High-Rate Methane Fermentation of Lipid Rich Food Wastes by High-Solids Co-digestion Process”. *Water Science and Technology*. 45 (12), 143–150.

Sperling Hansen Associates., Capital Region District Solid Waste Compositional Study 2004-2005 Final Report, May 2005.

Technology Resource Inc., North Vancouver, B.C. “Solid Waste Compositions Study” for Greater Vancouver Regional District, January 14, 2005.

Wiltsee, G., Appel Consultants, Inc., Valencia, California, “Urban Waste Grease Resource Assessment” for the National Renewable Energy Laboratory, November 1998, NREL/SR-570-26141.

Waste Diversion Ontario, 2007 Datacall, GAP Diversion for Large and Regional Municipalities.

Section 5 Biosolids Processing Components and Alternatives

The biosolids treatment facility will incorporate several unit processes to facilitate stabilization and disposal or beneficial reuse. In practice, the most commonly used biosolids treatment options include solids thickening, stabilization, dewatering, and potentially thermal drying and WTE facilities. The selection of these process components will depend on economic evaluation, beneficial use requirements, and local conditions. The process components assumed for the evaluation are gravity belt thickeners, thermophilic anaerobic digestion, centrifugal dewatering, belt drying, mass burn for WTE at Hartland landfill, and fluidized bed incinerator for WTE at the plant. It is noted that other process components could also provide these functions. These options can be explored at the predesign phase. This section describes the selected process components and presents additional alternatives for the biosolids process components.

5.1 THICKENING

Sludge concentrations from upstream liquid processes can vary considerably depending on the treatment method used, process flow rates, and method of operation. Raw sludge volume reduction obtained by sludge thickening prior to solids stabilization processes provides several benefits, including increased capacity of tanks and equipment and reduced quantity of heat required to heat sludge for digestion or incineration. Thickening is accomplished by physical means; methods commonly used for thickening include the following:

- **Co-settling** – Settling of solids in process tanks, which is done typically in primary and secondary clarifiers
- **Gravity thickening** – Solids are thickened by gravity in a gravity thickener, usually a circular sedimentation tank with a sludge thickening/collection mechanism for solids removal.
- **Dissolved air flotation** – Dissolved air is released as fine bubbles that carry sludge to the liquids surface, where it is removed as thickened sludge.
- **Centrifugation** – Centrifugation is used to both thicken and dewater sludge, where centrifugal forces inside a solid bowl centrifuge are used to separate water from solids, thus thickening sludge.
- **Gravity belt thickening** – A gravity belt moves over rolls driven by a variable-speed drive. Sludge is spread over the gravity belt, where water drains by gravity and thickens the sludge.

CAPITAL REGIONAL DISTRICT

Core Area Wastewater Treatment Program
Biosolids Management Plan

- **Rotary drum thickening** – A rotating cylindrical screen separates flocculated solids from water, and sludge fed into the rotating screen rolls out the end of the screen as thickened sludge while water decants through the screen.

Gravity belt thickeners have demonstrated effective thickening of sludge—including waste activated sludge, which is especially difficult to dewater. It is not necessary to select the final thickening technology at this time; therefore, gravity belt thickeners have been selected as the thickening technology. Further analysis of thickening technologies will be completed during the predesign phase. **Figure 5.1** shows the Andritz belt filter press at the Salmon Creek WWTP in Vancouver, Washington.



Figure 5.1 – Andritz Belt Filter Press: Salmon Creek WWTP, Vancouver, Washington

5.2 SOLIDS STABILIZATION

The principal methods used for stabilization of sludge are alkaline stabilization (usually with lime similar to the CRD Saanich plant), anaerobic digestion, aerobic digestion, and composting. Of these technologies, anaerobic digestion has been the primary technology used to stabilize wastewater solids for the last 40 years. Anaerobic digestion provides solids stabilization, pathogen reduction, solids destruction, and generation of usable gas by-product. For this evaluation, anaerobic digestion was selected as the solids stabilization process. Further evaluation of the solids stabilization process may be performed during the predesign phase.

CAPITAL REGIONAL DISTRICT

Core Area Wastewater Treatment Program
Biosolids Management Plan

The most common form of anaerobic digestion is mesophilic digestion, in which the digester is operated at approximately 37°C, but other digestion technologies provide the ability to improve solids destruction, gas production, and pathogen removal. These advanced digestion technologies include the following:

- Thermophilic digestion
- Series digestion
- Temperature-phased anaerobic digestion (TPAD)
- Acid/gas digestion.

5.2.1 Mesophilic Digestion

Mesophilic digestion is the most commonly used anaerobic digestion process. Mesophilic digesters are operated within the mesophilic temperature range, 35° to 39°C, at solids retention times (SRTs) exceeding 15 days. Typically, loading criteria range from 1.6 to 2.6 kg volatile solids (VS)/m³/day, and limiting loadings rates of 3.2 kg VS/m³/day. **Figure 5.2** shows the mesophilic anaerobic digester at the Columbia Boulevard WWTP in Portland, Oregon.



Figure 5.2 – Mesophilic Anaerobic Digesters: Columbia Boulevard WWTP, Portland, Oregon

5.2.2 Thermophilic Digestion

Thermophilic digestion occurs at temperatures between 49° and 57°C, at conditions suitable for thermophilic microorganisms. Biochemical reactions increase with temperature; therefore, microbial reactions in thermophilic digestion are much faster than mesophilic digestion. The advantages of thermophilic digestion include increased solids destruction capability, improved dewatering, increased gas production, and increased pathogen destruction. Because of the

CAPITAL REGIONAL DISTRICT

Core Area Wastewater Treatment Program
Biosolids Management Plan

increased biochemical reaction rate, loadings to a thermophilic digestion have been reported as high as 7.2 kg VS/m³/day, significantly higher than those of a mesophilic digester. Disadvantages of thermophilic digesters include higher energy requirements for heating, poorer supernatant quality, and higher odours. Higher destruction rates in a thermophilic digester release greater concentrations of ammonia which contributes to the poorer supernatant quality; the liquids steam processes need to be analyzed to determine the impact of ammonia return with the supernatant after dewatering. Thermophilic digestion requires additional heat exchangers relative to mesophilic digestion to heat the digester to higher temperatures, but heat recovery heat exchangers can greatly reduce heating costs. **Figure 5.3** shows the thermophilic anaerobic digesters at the Annacis Island WWTP in Delta, BC.



Figure 5.3 – Thermophilic Anaerobic Digesters: Metro Vancouver’s Annacis Island WWTP

5.2.3 Series Digestion

Two or more digesters operating in parallel can be placed in series for improved process performance. With parallel operation of two digesters, digester feed is split and fed equally to both digesters. In series operation, the digester feed is sent to the first digester, the digested sludge from the first digester is transferred to the second digester, and digested sludge from the second digester is transferred to dewatering. At the Annacis Island plant shown in **Figure 5.3**, three digesters are placed in series following four in parallel in a process named extended-thermophilic digestion. By placing the digesters in series, the process approaches plug-flow design and offers improved process performance. Series operation has been reported to improve solids destruction and increase gas production relative to parallel operation. A design with tanks in series reduces the potential for short circuiting and offers improved pathogen reduction.

5.2.4 Temperature-Phased Anaerobic Digestion (TPAD)

TPAD incorporates the advantages of thermophilic digestion and mitigates the disadvantages through the incorporation of mesophilic digestion to improve performance. TPAD utilizes digesters in series, where the first stage is thermophilic followed by one or more mesophilic stages. The high biochemical reaction rate in the thermophilic digester improves solids destruction capability, improves dewaterability of the sludge, increases gas production, and increases pathogen destruction rates. The thermophilic stage has the ability to process loading rates that are significantly higher than those of mesophilic digesters. The following mesophilic stage(s) improve the performance of the digestion efficiency and mitigates the disadvantages of thermophilic digestion, which includes poorer supernatant quality and odours. The mesophilic stage(s) improve the solids destruction, reduce the odours produced during the thermophilic stage, and improve supernatant quality. The higher temperature of the thermophilic stage and configuration's ability to minimize short circuiting contributes to greater pathogen destruction. Similar to thermophilic digestion, a greater number of heat exchangers are required to heat the sludge to thermophilic temperatures and then cool the sludge to mesophilic temperatures. Heating costs can be minimized through heat recovery.

5.2.5 Acid/Gas Digestion

The acid/gas digestion process utilizes two reactors in series to separate the anaerobic digestion phases, the formation of acids (acidogenesis), and the generation of gas (methanogenesis), to improve the process performance. In the first stage, solubilization of organic matter occurs and volatile acids are formed. The first stage is operated at a short SRT to promote the formation of acids. The second stage is operated as either a mesophilic or thermophilic digester, in which volatile acids from the first stage are converted to gas. The separation of the anaerobic digestion phases results in improved solids reduction, increased gas production, reduced potential for foaming, and improved pathogen destruction. One disadvantage of acid/gas digestion is the generation of significant odours in the first stage, the acid formation phase; therefore, the acid phase may require odour control. Often the headspace of the acid phase is connected to the digester gas system, but the acid phase will produce CO₂ gas which may dilute the methane content of the digester gas.

Thermophilic digestion has the ability to produce Class A biosolids, which provides greater opportunities for biosolids disposal/reuse than Class B sludge. In addition, thermophilic digestion can operate at much greater loading rates than mesophilic digestion, operate with greater stability over a wide range of operating conditions, and provide better performance when co-digesting alternative wastes. Greater volatile solids destruction and higher gas production rates (approximately 10% to 20%) than mesophilic digestion will increase revenue of gas utilization options while decreasing disposal costs. For these reasons, thermophilic digestion has been selected as the solids stabilization process. Further analysis of the stabilization process may be completed during the predesign phase.

5.3 DEWATERING

Dewatering, the removal of water from the biosolids, will reduce the weight/volume of solids requiring disposal and may reduce the costs associated with disposal or reuse. In addition, dewatering can reduce the heat demand required for thermal drying or other thermal processes. The primary technologies used for dewatering are belt filter presses, high-speed centrifuges, screw presses, and rotary presses.

5.3.1 Belt Filter Press

Belt filter presses are sludge dewatering devices that use the principles of chemical conditioning, gravity drainage, and mechanically applied pressure. When using polymer, belt filter presses can typically produce sludge with 18% to 23% solids content and can usually capture more than 95% of the solids. The belt filter press is an open process and significant odour may result; therefore, direct odour control over the belt filter press is required and enclosure of the belt filter presses may be necessary to reduce odour control requirements.

5.3.2 High-Speed Centrifuge

In a centrifuge, the applied centrifugal force causes suspended solids to migrate through the liquid, away from the axis of rotation due to the difference in densities between the solids and liquids, and the solids are then conveyed via auger, also called a scroll, to one end of the machine for discharge. High-speed centrifuges produce biosolids cake with solids concentrations comparable to or higher than produced by belt filter presses for similar applications. When using polymer, centrifuges can typically produce sludge with 20% to 30% solids content and usually capture more than 95% of the solids. Centrifuge dewatering is a closed process, which makes containment of odours easier. Dewatered cake from a centrifuge is generally more odorous and odour control is required on the cake and centrate outlets, but because odour control is at point sources, smaller foul air volumes must be treated. **Figure 5.4** shows the high-speed centrifuge at the South Treatment Plant in Renton, Washington.



Figure 5.4 – High-speed Centrifuge: South Treatment Plant, Renton, Washington

5.3.3 Screw Press

A screw press consists of a tapered screw with a surrounding screen, and sludge conveyed down the length of the screw is dewatered through compression of the sludge between the tapered screw and the reducing diameter of the surrounding screen. The typical dewatering performance is similar to the rotary press on combined municipal sludges with expected solids contents in the 18% to 26% range. Polymer requirements are similar to a belt filter press. The screw press is most cost-effective in applications where continuous operation is desirable, since the unit can be smaller to dewater the same quantity over 24 hours than over 8 hours.

5.3.4 Rotary Press

In a rotary press, sludge is fed into a rectangular channel and slowly moves between two parallel revolving screens, which rotate very slowly on a single shaft. The filtrate passes through the screens as the flocculated sludge advances along the channel. The sludge continues to dewater as it passes around the channel, eventually forming cake at the outlet side of the press. A controlled outlet restriction maintains pressure inside the unit, resulting in the extrusion of dry cake. Each disk set is called a channel, and dewatering capacity can be increased by adding channels. Up to six multiple channels can operate on a common gear box and centre shaft to minimize energy requirements. The typical dewatering performance is similar to the screw press on combined municipal sludges with expected solids contents in the 18% to 26% range. The rotary press has enclosed dewatering channels that minimize odour control requirements.

Centrifugation typically achieves the highest solids concentrations of any dewatering technology and the product is suitable for many uses, including land application, thermal drying, and other beneficial reuse alternatives. For these reasons, centrifugation has been selected as the dewatering technology. Further analysis of dewatering technologies may be completed during the predesign phase.

5.4 THERMAL DRYING AND HIGH-TEMPERATURE HEAT PUMPS

Thermal drying involves the application of heat to evaporate water and reduce the moisture of biosolids, producing Class A biosolids available as a soil amendment or potential fuel. Increasingly, wastewater treatment facilities seek to produce Class A biosolids because they have significant benefits over conventional Class B biosolids. Heat-dried Class A biosolids reduce the mass of biosolids by a factor of approximately 6 because they contain less water, significantly reducing hauling costs, and improving storage capacity. Many types of dryers are available, providing several options for wastewater agencies. Both indirect and direct dryers are often used for drying of municipal biosolids.

The terms “conduction” and “indirect” drying have often been synonymous and generally mean drying by circulating a thermal fluid through the walls and auger/paddles of the dryer. These drying systems evaporate the water through conductive heating of the biosolids. The slow rotating auger moves the biosolids through the drying chamber and the systems can be batch or continuous. The final product tends to be a more uneven, “clumpy” product. The thermal fluid (or steam) is heated in a boiler and pumped through the auger and walls. These dryers are generally applicable to small and medium plants.

The terms “convection” and “direct” drying have often been used interchangeably and generally mean drying by circulating hot air around and through the biosolids. These systems evaporate the water through convective heating of the biosolids. Convection or direct drying is typically accomplished on a belt or in a drum.

Drum dryers mix the dewatered cake with a portion of the dried product to get about 45% solids concentration prior to transporting the mixture to the drying chamber. This process “coats” the surface of smaller particles and the rotating action of the dryer creates a round, smooth pellet. The addition of screening allows for control of the product size, which is typically 1 to 4 mm. Because of the rotation of the drum and agitation of the products, the drum dryers tend to create dust and additional equipment is required for dust control and to create an atmosphere inert in key components of the process. The evaporation energy is provided by sending the combustion gases directly into the drum; drum dryers are therefore considered higher-temperature dryers. The movement of the combustion gases is also what moves the product through the dryer. Drum dryers are larger systems and tend to be applicable to medium and large plants and where marketing of the final product is a key consideration.

CAPITAL REGIONAL DISTRICT

Core Area Wastewater Treatment Program Biosolids Management Plan

In belt dryers, the dewatered cake is extruded onto a porous belt using pumps or conveyors. The belt moves slowly as the air is circulated through the belt and biosolids evaporating the water. The belt dryers using extrusion tend to produce a longer (1 to 5 cm), smaller-diameter, pelletized product; the belt dryers using conveyors tend to produce a more uneven, “clumpy” product. Dust is fairly minimal in belt dryers because the dried biosolids are stationary on the belt through the drying process. The circulation air is generally heated in air-to-air heat exchangers, but they can also use combustion gases directly into the drying chamber. Belt dryers are generally categorized as medium-temperature, but are capable of low-temperature operation. This provides the opportunity for use of waste heat or effluent heat extraction as the energy source, thus reducing the operating energy cost. Belt dryers are generally applicable to small and medium plants.

This evaluation assumes that a thermal dryer will be used to dry a portion of the solids produced at the CRD facilities. At this time, it is not necessary to select the final drying technology. A direct belt dryer is recommended as the drying technology for its ability to operate at low temperature to reduce energy costs. Further analysis of drying technologies may be completed during the predesign phase. It is also assumed that effluent heat extraction will be the primary source of heat for the drying process (see below). If an FBI with a non-condensing turbine is implemented at the treatment plant, the available steam can be used as the heat source for drying and heat pumps are not required.

Kruger has provided a preliminary proposal and mass/energy balance for this project. The belt dryer proposed for this application will use the 2-belt drying process similar to that shown in **Figure 5.5**. The dryer system proposed for CRD will include heat using effluent heat extraction and the drying chamber will require four separate heating zones by partitioning the inside of the chamber. Each zone will have two dedicated fans and a heat exchanger for transfer of energy from the hot water loop to the drying chamber. The first zone is the primary evaporation zone where most of the water at or near the surface of the particles is evaporated—the larger heat exchanger and fans are used in this zone. In the subsequent zones, the rate of evaporation is slower since the water must conduct or diffuse through the solid particle before reaching the surface for evaporation. In addition to the fans and heat exchangers, the drying system requires cake hoppers and pumps, exhaust fans, and condensers.

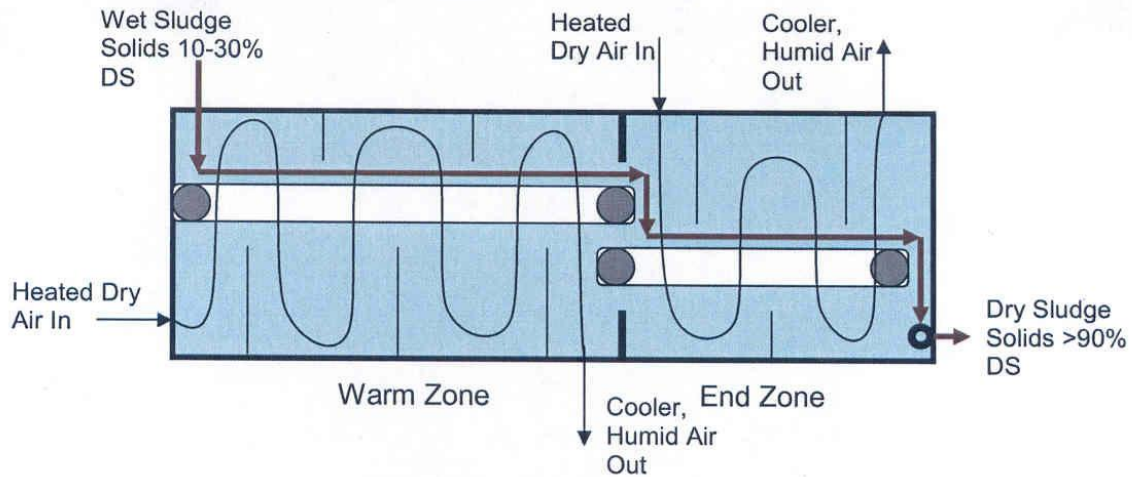

Figure 5.5 – Belt Dryer Flow Diagram

Figure 5.6 shows a photo of Kruger’s belt dryer installation in Randers, Denmark—this system uses waste heat from a cogeneration engine that operates on digester gas. Figure 5.7 shows two photos from inside this belt dryer. The first photo shows the beginning of the dryer where the dewatered biosolids are pumped/extruded onto the belt; the second photo shows the end of the process where the dried biosolids drop onto a loadout conveyor.



Figure 5.6 – Belt Dryer, Randers, Denmark



Figure 5.7 – Inside the Belt Dryer, Randers, Denmark

The biosolids drying system is sized for the average month. The use of supplemental fuel or electric resistance heat can be used to boost temperatures and add drying capacity for the peak months. Potential fuel options include the waste gas stream from the PSA system discussed in Section 6 and digester gas. This additional heat should be added to the first stage of a belt dryer. Because the peak day is about 25% larger than peak month, this energy booster system could be implemented to allow full drying capacity at any day.

As noted above, the dryer will be heated using effluent heat extraction with heat pumps. The plant hot water heat loop will also be heated using effluent heat extraction and have a supply temperature of 68°C (for heating sludge, digesters, and buildings). A biosolids dryer will require a higher temperature for drying and a secondary hot water heat loop using high-temperature heat pumps can be added to provide the necessary water supply temperature for drying (about 93°C). A diagram of the high-temperature heat pump tied in to the plant hot water heat loop is shown in **Figure 5.8**.

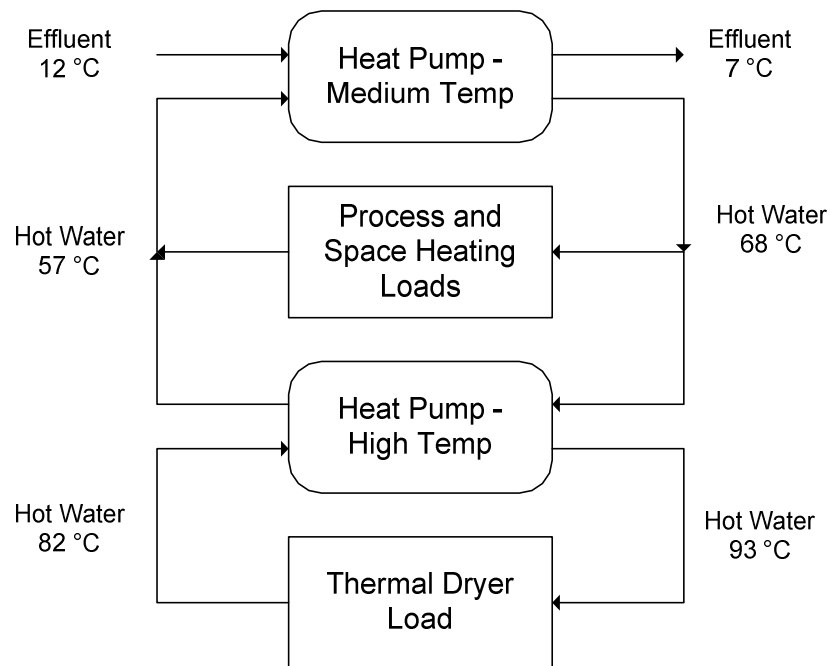

Figure 5.8 – High-temperature Heat Pump for Thermal Sludge Drying

5.5 WASTE-TO-ENERGY EQUIPMENT

Incineration of biosolids is primarily a means of biosolids handling by reducing the volume of waste. Incineration is a thermal oxidation or combustion process in which the organic matter or volatile solids (VS) are destroyed at high temperatures in the presence of oxygen. Dewatered biosolids are often combusted in multiple hearth furnaces (MHFs), but fluidized bed incinerators (FBIs) are currently the preferred technology for both dewatered and dried biosolids (see also Section 3.2.4). Because of the low water content in dried biosolids, the combustion process is autogenous and creates opportunities for heat recovery and power generation. For purposes of the biosolids management scenario that includes a WTE at the treatment plant, FBIs are assumed.

Dewatered or dried biosolids can also be combined with municipal solids waste and incinerated in a mass burn WTE facility (see also Section 3.2.4 and 4.4). Conventional combustion, more specifically a mass burn moving grate system, is the only approach that is capable of managing unprocessed MSW with variable composition similar to that which would be available in the CRD and is commercially proven. In addition, for this technology there is a more reasonable set of reliable system performance data and costs. There is a high degree of variability in the reported capital and operating costs. This variability reflects the differences in facility design and scale for mass burn facilities.

CAPITAL REGIONAL DISTRICT

Core Area Wastewater Treatment Program Biosolids Management Plan

For the purpose of developing integrated MSW and biosolids management scenarios, it is recommended that a conventional mass burn moving grate system is assumed. In the future, should it be determined to pursue the development of a WTE system, other technologies may have been proven to operate with similar waste streams in other jurisdictions. It would be reasonable to allow for a wider range of technology vendors to make submissions in any future qualifications processes that may be undertaken to identify a preferred approach for WTE.

A single-unit conventional mass burn moving grate system has been used for the purpose of analyzing the MSW/biosolids WTE integration scenarios. However, smaller multiple unit options exist and may upon further study offer some benefits for scaling up WTE over time. If a MSW/biosolids WTE integration scenario is carried forward, it is recommended that consideration be given to variations regarding the scale of the units that could be developed and an implementation time frame that would allow for some flexibility in the system.

5.6 BIOSOLIDS PROCESSING RECOMMENDATIONS

Table 5.1 summarizes the biosolids preliminary processing recommendations from this section. These technologies are assumed in the further evaluations presented in this report. During the design phase of the program, a further evaluation of specific technologies for each processing step will be conducted. However, the final technology selection is not anticipated to affect the outcome of general process and end use alternative selections discussed in this report.

Table 5.1 – Biosolids Preliminary Processing Recommendations

Biosolids Process	Recommendation
Thickening	Gravity belt thickener
Solids stabilization	Thermophilic anaerobic digestion
Dewatering	Centrifuge
Drying	Low-temperature belt dryer Heat supplied by heat pumps and effluent heat extraction ^{1,2}
WTE at the wastewater treatment plant for biosolids only	Fluidized bed incinerator ^{1,2}
WTE at Hartland landfill for biosolids and MSW	Mass burn using travelling grate (conventional technology) ^{1,2}

Notes:

1. If the WTE at the wastewater treatment plant for biosolids only is implemented, heat for the drying process can be supplied from the non-condensing steam turbine.
2. If the WTE at Hartland is implemented, considerations could be given to locating the dryer at the landfill. This provides an opportunity to use steam as the heat source for the drying process.

Section 6 Biogas Utilization

6.1 INTRODUCTION

The CRD's new WWTP biosolids processing facilities will likely include digesters to reduce the amount of residual biosolids. The digestion process will produce a biogas consisting of about 62% CH₄ (dry) and 38% CO₂ (dry) by volume and water saturated. The biogas can be utilized in a number of ways. Upgrading the biogas to pipeline-grade biomethane for direct sale is a utilization alternative that would directly offset the use of natural gas or other fossil fuels, resulting in a potential credit for carbon emissions as well as generating a revenue stream. Utilizing the biogas for cogeneration would provide a proportion of plant heat and electricity, resulting in a smaller carbon emission credit than using the biogas for direct sale due to the large amount of hydropower used to create electricity in the region. The components of these alternatives are discussed in the following sections.

6.1.1 Biogas Production

The biogas production rate depends on a number of variables, including the loading rate, number, order, ambient pressure, and temperature of the digesters and the types of materials loaded to the digesters. The quantities of biosolids generated from wastewater treatment are discussed in Section 2. Biogas production parameters and the biogas production calculations, assuming co-digestion with FOG, food waste, and other organic substrates, are discussed in Section 4. The biogas constituents from digester gas are assumed from past data and experience and are shown in **Table 6.1** with the biogas production rates. The addition of FOG to the digesters would likely provide a higher overall methane content of the biogas. The biogas produced at the Upper Victoria Harbour and West Shore sites is split approximately 80% and 20%, respectively, consistent with the relative amount of wastewater that will be treated at these two sites. Depending on the configuration and final siting of the West Shore plant it is possible that biosolids from the West Shore could be processed at the central facility in the Upper Victoria Harbour.

CAPITAL REGIONAL DISTRICT

Core Area Wastewater Treatment Program
Biosolids Management Plan

Table 6.1 – Biogas Production

Parameter	Units	Range	Average
Biogas production	Nm ³ /day	4,850–24,250	18,500
CH ₄	Vol %, wet	52–61	58.3
CO ₂	Vol %, wet	33–42	35.7
Nitrogen	Vol %, wet	0.2–2	0.2
Water	Vol %, wet	5.5–6.5	5.8
Hydrogen sulphide	ppm	0–2,000	500
Siloxanes	mg/Nm ³	4–140	25
Lower heating value	MJ/Nm ³	18.6–21.8	20.9
Higher heating value	MJ/Nm ³	20.7–24.3	23.2

Note:

1. Data based on CH₄ heating values from Turns 2000.

Biogas utilization requires varying degrees of gas conditioning, depending on the utilization technology. Impurities in the biogas such as hydrogen sulphide and siloxanes can lead to severe corrosion, equipment deterioration, and maintenance problems. A basic summary of the biogas treatment requirements for utilization options is provided in **Table 6.2**. A further description is provided in the individual sections for each technology except for the section for boilers, which is shown as a baseline technology.

Table 6.2 – Biogas Treatment Required

Option	Water Removal	H ₂ S Removal	First Stage Compression	Siloxane/VOC Removal	CO ₂ Removal	Final Compression
Boilers	Yes	Maybe	Maybe	Maybe	No	No
Internal combustion (IC) engine or turbine	Yes	Yes	Yes	Yes	No	No
Pipeline biomethane	Yes	Yes	Yes	Maybe ¹	Yes	Maybe
Compressed biomethane	Yes	Yes	Yes	Maybe ¹	Yes	Yes

Note:

1. The CO₂ removal systems may be able to remove siloxanes without a separate scrubber.

6.2 COGENERATION TECHNOLOGY

Cogeneration plants simultaneously produce electricity and heat. Cogeneration is common at WWTPs because of the need for process and space heating as well as electricity. The biogas is most commonly combusted in either an internal combustion (IC) engine or in a turbine to produce electricity. The heat from the hot combustion gases, and in the case of IC engines the hot engine block, is then recovered with either a hot water or steam loop.

Cogeneration would provide an economic and environmental benefit, but will not likely provide the most benefit in either of these two categories. The electricity produced by the cogeneration will offset the electricity that would otherwise be consumed by the WWTP or other grid users. The relatively low electrical rates and small carbon footprint from grid energy in the Victoria region, primarily sourced from hydro power, minimize the economic and environmental benefits. The heat produced by cogeneration is normally used for building and digester heating. However, in the case of technologies selected for digester heating for CRD, it would offset electricity for effluent heat recovery using heat pumps. While the offset for building and process heating for cogeneration recovered heat would be a real benefit, the thermodynamic advantage of effluent heat extraction would in that case be lost.

Although a small gas turbine may be an acceptable technology for the larger Upper Victoria Harbour site, the amount of digester gas would have overall better utilization by IC engines at both sites. At the peak 15-day gas flow, two lean-burn IC engines of 860-kW electrical capacity each at the Upper Victoria Harbour site and one-lean burn IC engine of 400-kW at the West Shore site would utilize all the biogas from the digesters. The engines would be configured with jacket water and exhaust heat recover systems that would provide heat for process heating.

Gas treatment to protect the IC engines would be required. Typical treatment will remove hydrogen sulphide with an iron sponge or iron-oxide-impregnated material. Compression, chilling, and water removal would follow. The siloxane removal system would likely be a regenerative system which would produce a waste gas stream during the regeneration cycle, and require a flare. A regenerative system is assumed here based on the economies of scale for this technology and the size of the application. **Figure 6.1** shows the basic schematic of a cogeneration plant for the Upper Victoria Harbour and West Shore sites.

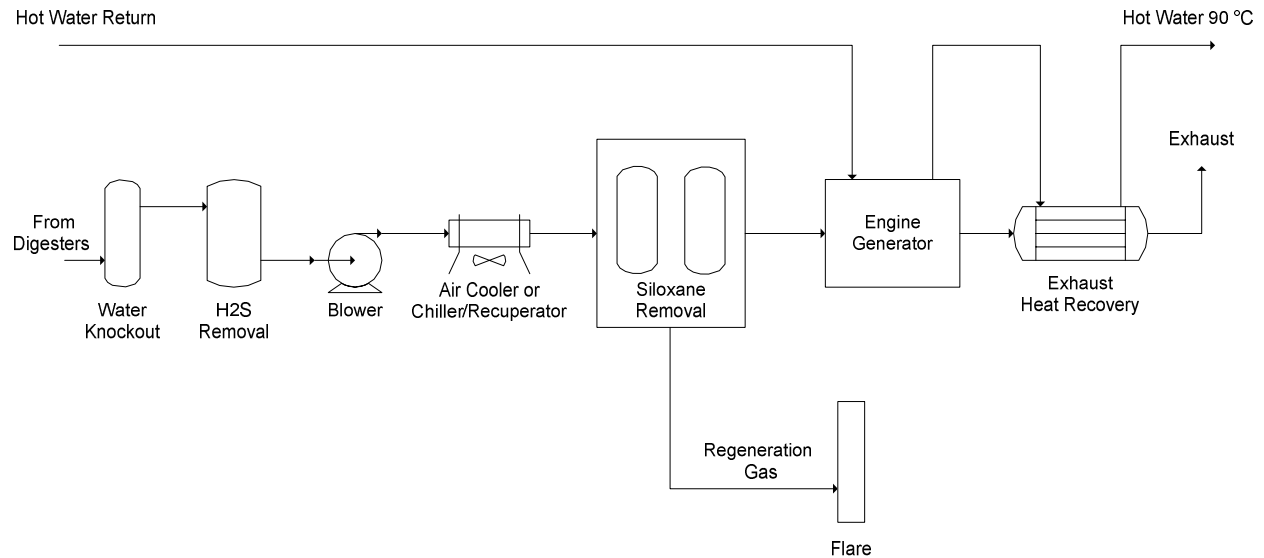

Figure 6.1 – Cogeneration System Schematic

At typical efficiencies, the combined electrical and heat production rates from the two sites can be expected to be about 1.6 MW of electricity and 1.8 MW of heat respectively at average biogas flows and 95% availability. With regenerative siloxane removal systems installed for biogas treatment, an 8% to 10% loss of CH₄ can be expected, resulting in 1.4 MW of electricity and 1.6 MW of usable heat. One major disadvantage of cogeneration is that recovered heat has limited value in the summer and much of it would be wasted. **Figure 6.2** shows the 4-MW cogeneration system at Metro Vancouver’s Annacis Island WWTP, which has been in operation since about 1997.



Figure 6.2 – 4-MW Cogeneration System at Metro Vancouver’s Annacis Island WWTP

6.2.1 Biogas Upgrading to Biomethane

Conversion of biogas to compressed biomethane for pipeline or fuel vehicle use is not a new concept. More than 10 plants in the U.S. are currently upgrading landfill gas to high-Btu compressed biomethane, including plants in Los Angeles, California; Cincinnati, Ohio; Santa Rosa, California; and Cedar Hills, Washington (LMOP 2009). Digester gas is similar to landfill gas, but in many ways is easier to process because of much lower concentrations of nitrogen, oxygen, and volatile organic compounds (VOCs). At the WWTP in Renton, Washington, King County operates two 1,400-Nm³/hr gas scrubbing systems that inject biomethane into the natural gas pipeline. At the Sacramento, California, WWTP, biomethane is sold to a local utility that uses it in a large utility-scale turbine cogeneration system.

Upgrading biogas to compressed biomethane to meet pipeline quality requirements will likely be the best economic and environmental utilization for the biogas. Biogas upgraded to high-Btu biomethane can be sold for a much higher price than a low- or medium-Btu gas and can be used as a direct replacement of fossil fuels. Biomethane will displace natural gas if injected into a natural gas pipeline and diesel or gasoline if used for vehicle fuel. The economic and environmental advantage of upgrading biogas to biomethane is further supported if grid electricity is cheap and is generated by renewable sources (hydro power) such as that supplied to Greater Victoria. The heat and electricity required for the plant operation can be grid-generated at low cost and low environmental impact.

A critical component for upgrading biogas to biomethane for pipeline injection is the willing cooperation of the natural gas provider with existing compatible infrastructure. In order for the WWTP to minimize risk of energy sale prices, a long-term favourable price for upgraded biomethane is beneficial. Terasen is the local natural gas provider and has expressed interest in proceeding with a long-term contract for this renewable energy.

Upgrading biogas to compressed biomethane for pipeline- or vehicle-grade use has some disadvantages. In general, the technology can be more complex than cogeneration systems and may require skilled operators or a service agreement to keep the plant operating. The power required to run the system adds a fairly high parasitic load due to the requirement to compress the biogas for processing and end use, but still far less than represented by the fossil fuel offset benefit.

6.2.2 Biogas Upgrading for Pipeline Injection

The gas treatment for pipeline injection depends on the technology chosen for CO₂ removal. There are three major categories of technology to remove CO₂: solvents, pressure swing adsorption, and membranes. The technologies for CO₂ removal are significantly different in the physical and/or chemical processes. The choice of CO₂ removal technologies during detailed design should take many factors into account, including CH₄ recovery efficiency, reliability, power and heat requirements, maintainability, final pressure, size, and cost.

CAPITAL REGIONAL DISTRICT

Core Area Wastewater Treatment Program
Biosolids Management Plan

Pressure swing adsorption (PSA) technology was preliminarily selected in this early design phase for a number of reasons. PSA systems have been installed on digester biogas plants as small as 200 Nm³/hr and on landfill gas plants up to 7,000 Nm³/hr. These systems are available in modular units from Canadian manufacturers and have proven successful at the scale of this project. While the design will require some customization, the availability of standardized modules should make operation and maintenance easier and less costly. This technology is viable economically at the size required for both the Upper Victoria Harbour and West Shore sites. A PSA system rated for 7,000 Nm³/hr for landfill gas upgrade is shown in **Figure 6.3**.



Figure 6.3 – QuestAir PSA System at Rumpke Landfill, Ohio

The biogas produced by the digesters will be upgraded to high-quality biomethane and injected into the natural gas pipeline owned by Terasen. The plant capacities at the two sites were sized to handle 15-day peak flow rates. The specifications for injecting compressed biomethane into a natural gas pipeline vary to a small degree between pipeline owners. The biogas upgrading system will need to consistently meet the gas specifications set forth or negotiated with Terasen. The expected specifications for the natural gas pipeline are provided in **Table 6.3**.

Table 6.3 – Compressed Biomethane Gas Constituents

Constituent	Typical Natural Gas Specifications
CH ₄ , % by volume	> 97
CO ₂ , % by volume	< 2 to 3
Nitrogen, % by volume	< 3 to 4 (inc. O ₂ , CO ₂)
Oxygen, % by volume	< 0.2 to 0.4
Water (mg/ Nm ³)	< 65
Ammonia	N/A
Hydrogen, % by volume	< 0.2
Hydrogen sulphide (mg/ Nm ³)	< 23
Siloxane (mg/Nm ³)	N/A
NMOCs (mg/Nm ³)	-
Halogens (mg Cl,F/Nm ³)	-

The biogas upgrading process will involve multiple stages of compression and purification. Hydrogen sulphide and bulk water are removed at the beginning of the process at low pressure. A scavenging media removes hydrogen sulphide. The sweetened biogas is then compressed and run through a two-stage PSA system to remove CO₂, water, and other impurities (e.g., siloxanes). The second-stage PSA system upgrades the waste gas of the first-stage PSA system and the combined process produces a high CH₄ recovery rate of about 95%. The upgraded biomethane will be 98% CH₄ and will meet the required pipeline specifications for impurities. The pressure of the biomethane sent to the pipeline is assumed to be 10 bar, but will be verified in the design process. The waste gas from the second-stage PSA will be combusted in an enclosed flare or other combustion device with an assumed 99% CH₄ destruction efficiency. No impurity removal system upstream of the first stage PSA was assumed based on the manufacturer’s input, but this should be investigated during detailed design. A schematic of the biogas upgrading system is shown in **Figure 6.4**.

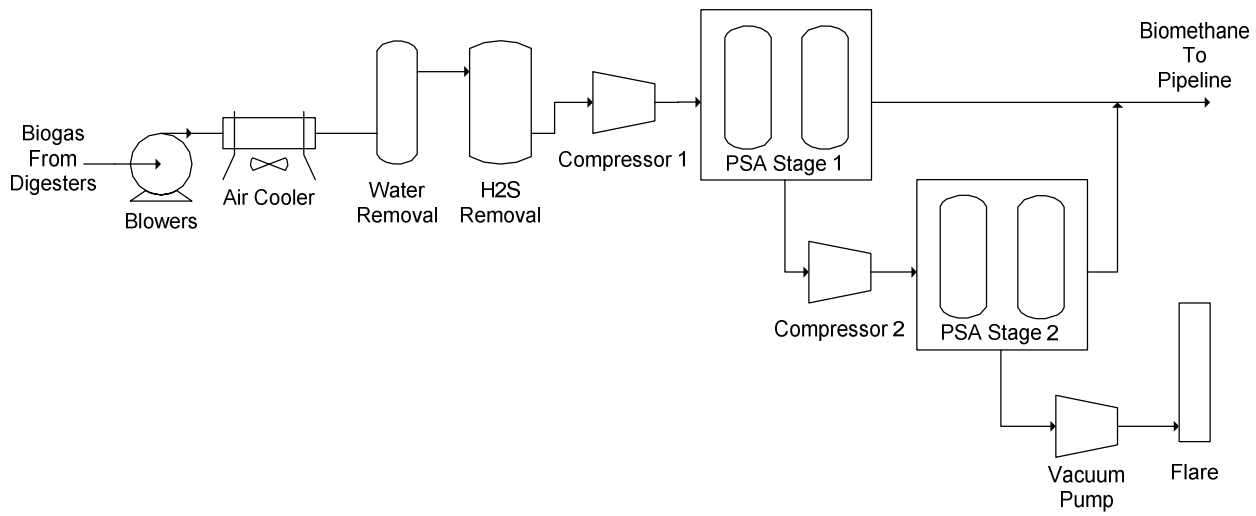

Figure 6.4 – Biogas Upgrading System Schematic

The waste gas from the second PSA stage that is sent to the flare is commonly referred to as the tail gas. The tail gas presents a combustion challenge because of its low CH₄ content. The lower limit for CH₄ content to provide for adequate combustion in an enclosed flare is about 25 to 30%. The tail gas will have 10% to 15% CH₄ which will likely require a gas-assisted flare. A slip stream of product biomethane of about 2.5% of the total biomethane flow will be required for the flare. With system availabilities of 95%, the expected biomethane production from the two sites will be about 377 GJ/day at higher heating value.

The costs for biogas upgrading systems at the Upper Victoria Harbour and West Shore sites were estimated for the site selection analysis. The estimated installed costs for the systems are \$5.8 million and \$3.0 million based on budgetary estimates from the supplier. The maintenance costs were estimated at \$100,000 and \$60,000 per year based on supplier input (in CAN\$). The combined average electricity used in the process will be about 250 kW.

6.2.3 Option 1: Utilizing Tail Gas Heat

A different combustion technology, such as a thermal oxidizer or venturi burner system, may be able to make use of the tail gas for process heat. A thermal oxidizer or venturi burner can be designed to combust the tail gas and recover the heat in a heat exchanger or use the combustion product gases directly. This high-grade heat can be used as a partial heat source for the sludge dryer which would reduce the dryer size. Using the combustion product gases directly for drying would avoid foiling of a heat exchanger from siloxanes present in the tail gas. If 65% of the available higher heating value in the tail gas is recovered for dryer use, it would constitute 0.25 MW of heat. Thermal oxidizers are about 4 times more expensive than enclosed flares, but have better emission control capabilities.

CAPITAL REGIONAL DISTRICT

Core Area Wastewater Treatment Program
Biosolids Management Plan

An additional option to the two-stage PSA system is to use a single-stage PSA system with a thermal oxidizer or modified boiler burning the tail gas. With this option the tail gas would account for 20% of the CH₄ in the digester gas and could provide about 0.75 MW of heat if 65% of the higher heating value is recovered. This would reduce the cost of upgrading the system because only one PSA stage is needed, and would reduce the size of the drier. The downside of this option is a lower CH₄ recovery efficiency of about 78%.

6.2.4 Option 2: Biogas Upgrading for Vehicle Use

Upgraded biomethane for vehicle use can also be a favourable economic and logistical scenario if a compressed natural gas (CNG) vehicle fleet such as buses, taxis, or garbage trucks is in close proximity and fuel costs are high. The diesel or gasoline that would otherwise be consumed by the fleet vehicles would be displaced by compressed biomethane at a competitive price. Conversion of fleet vehicles to run on CNG is well proven, and dedicated engines and vehicles direct from manufacturers are available (NGV America).

The process of upgrading biogas to compressed biomethane for vehicle fuel is very similar to that for pipeline injection. The few differences include a final CH₄ requirement of greater than 95% CH₄ rather than 97% CH₄, and a final pressure of 200 to 250 bar. The additional compression will mean higher parasitic electrical loads. Storage of the compressed biomethane would allow for a constant flow of biomethane from the digester and dispensing as needed to the vehicle fleet. A one-line compressed biomethane dispensing station would be installed to refuel the vehicle fleet. The required equipment is shown in **Figures 6.5** and **6.6**.

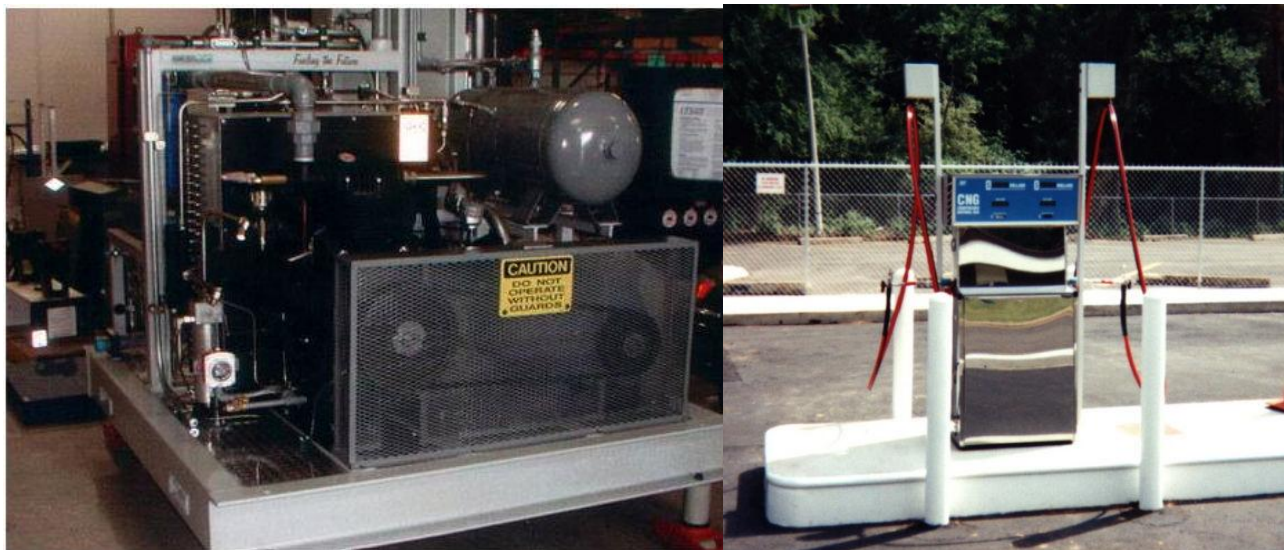

Figure 6.5 – Gardner Denver Packaged CNG Compression Station and CNG Dispensing Unit from Tulsa Natural Gas



Figure 6.6 – Compressed Gas Storage Cylinders

6.3 ALTERNATIVE SCREENING

A qualitative comparison of biogas utilization technologies is described in this section and is based on industry and location-specific data for Greater Victoria. The key points of the comparison are summarized below. Whereas it is not the intention of this report to present a full technical comparison of a biogas utilization technologies, sufficient information is available based on qualitative comparison to make a firm recommendation.

- The installed capital costs for biogas upgrading plants are about equal to or less than those for cogeneration with IC engines.
- A WWTP with a biogas upgrading plant will have higher electrical loads than that with a cogeneration plant. However, operation and maintenance costs may likely favour biogas upgrading over cogeneration because electricity rates are expected to be low.
- The ability to make a long-term contract for sale of the biomethane to Terasen reduces the risk of the revenue stream volatility for biogas upgrading. This takes away a major advantage from cogeneration as electricity prices are typically much less volatile than that of natural gas. There may be a possibility to contract out the construction and operation of the biomethane treatment system to a third party such as Terasen, who may be interested in controlling and assuring gas quality prior to being fed to their pipeline.
- The grid electricity in the Victoria area is largely supplied by hydropower, making the displacement of electricity with cogeneration much less effective at reducing GHG emissions than biomethane displacing natural gas, gasoline, or diesel.

CAPITAL REGIONAL DISTRICT

Core Area Wastewater Treatment Program
Biosolids Management Plan

- Effluent heat recovery offers a thermodynamic advantage to providing heat for process and space heating. Utilizing recovered heat from cogeneration or the biogas for heat production can be considered a loss of this thermodynamic advantage.
- Biomethane can always be injected to the natural gas pipeline or storage containers except under rare occasions, but the heat from cogeneration may not always be utilized. Summertime conditions and times of low solids drying rates will reduce the beneficial use of the available heat from cogeneration.
- Biogas upgrading may be more complex to operate, but with modular systems and Canadian vendors, the operation of the plants may well be easier than for a cogeneration system.
- The options to recover the heat from the biogas upgrading tail gas and to fuel fleet vehicles with compressed biomethane offer further possibilities to reduce the carbon footprint of the WWTP.

Based on the above qualitative comparison, biogas upgrading to saleable biomethane for both the Upper Victoria Harbour and West Shore sites will likely provide the greatest economic and environmental benefit for biogas utilization and is recommended for further development. Sale of the biomethane to the local utility (Terasen) is assumed for all further evaluations in this report, but compression for vehicle fuel should be further considered if sale to the utility proves impractical for any reason.

6.4 REFERENCES

U.S. EPA Landfill Methane Outreach Program (LMOP), Operational LFG Energy Projects Database, 2009, <http://www.epa.gov/landfill/proj/index.htm>. Accessed on 10/20/2009

Section 7 Comprehensive and Integrated Biosolids/Solid Waste Processing and Siting Alternatives

The regional wastewater treatment program for the CRD to be constructed under Option 1A will provide a biosolids facility at an Upper Victoria Harbour site to treat biosolids from the McLoughlin Point wastewater treatment plant and a smaller biosolids facility adjacent to liquid stream treatment facilities at a West Shore site. A separate evaluation continues to address several alternatives for the Upper Victoria Harbour site, including (1) the liquids stream and biosolids treatment facilities co-located at a single site or (2) the liquids stream and biosolids facilities located at separate sites. If separate liquid stream and biosolids treatment facilities are selected, potential locations for the biosolids treatment facility may depend on the selected disposal/reuse options of the biosolids. The current assumption is that the smaller West Shore site will include liquids stream and biosolids treatment facilities co-located at this single site. In final project development, it may make sense for the West Shore biosolids treatment to be consolidated with the Upper Victoria Harbour biosolids at a separate site. This section also discusses combined biosolids and MSW WTE facilities that would be located at the CRD Hartland landfill.

This section describes comprehensive alternatives for wastewater solids processing and utilization, with consideration opportunities for integration with the solid waste program. The general facility layout of the biosolids treatment facility at the Upper Victoria Harbour site is illustrated. To address the variations in layout for the different site alternatives, descriptions of any modifications to the general site layout will be included in this section. Selection and refinement of the site layout will be conducted after a final site is selected and during the predesign phase of program development.

7.1 BIOSOLIDS UTILIZATION OPTIONS

The CRD has the stated goal of integrating biosolids management with the existing MSW program. There are a number of ways to accomplish this ranging from strict disposal of biosolids in the landfill, co-digestion, combustion in a WTE system, and co-composting. Details on the alternatives for integrating the treatment of wastewater solids with MSW are described in Section 4. The alternatives that passed preliminary screening are summarized below.

7.1.1 Primary Solids Management Alternatives

- **Co-digestion at the WWTP site** – Co-digestion substrate (FOG, separated food waste products, etc.) are digested with raw solids in the thermophilic anaerobic digesters to increase biogas production. The digested biosolids are then dewatered and dried for

ultimate use. Benefits include centralization of gas production, treatment, and distribution. There are numerous options for biosolids product utilization including cement kiln fuel, topsoil manufacturing, biomass (e.g., willow coppice) production, and land reclamation.

- **Waste-to-energy (WTE)** – Solids are thermally combusted with heat and energy recovery. The following four distinct options are available for a WTE facility:
 - Raw dried biosolids are combusted at the biosolids treatment facility in a fluidized bed incinerator (FBI). Steam is generated to heat a thermal dryer, and excess steam is used to run steam turbines and generate electricity.
 - Digested biosolids are combusted at the biosolids treatment facility in an FBI. Steam is generated to heat a thermal dryer, and excess steam is used to run steam turbines and generate electricity.
 - Raw, dried biosolids are transported to a WTE facility located at or near the Hartland landfill and incinerated with solid waste in a mass burn facility. Steam is generated to run steam turbines to generate electricity.
 - Digested biosolids will be transported to a WTE facility located near the Hartland landfill and incinerated with solid waste in a mass burn facility. Steam is generated to run steam turbines to generate electricity.

7.1.2 Backup Solids Management Option

The primary solids management alternatives will be evaluated further to determine cost-effectiveness and carbon footprint. The primary solids management alternative ultimately selected will utilize 100% of the biosolids produced at the biosolids treatment facility. Regardless, a backup option for solids management is crucial to ensure that biosolids are reliably managed if the primary solids management alternative is temporarily unavailable.

As discussed in Section 3, landfilling biosolids meets the CRD needs and is recommended as the backup alternative for solids management. In the event of a treatment process failure or other unforeseen event that impacts the primary alternative(s), landfilling is readily available and requires minimal additional infrastructure beyond what already exists under CRD control to provide a reliable backup disposal option.

7.2 DIGESTION AND DRYING - GENERAL PROCESS DESCRIPTION

The biosolids facility utilizes several processes for solids stabilization and energy recovery. **Table 7.1** lists the processes included in the assumed generic site layout. The processes for the Upper Victoria Harbour and West Shore sites are assumed to be the same and the equipment and processes are scaled to reflect the differences in biosolids flows and loads. Further selection of equipment and processes at the two biosolids treatment sites will be conducted during detailed design.

**Table 7.1 – Biosolids Treatment Facility Process Descriptions:
Upper Victoria Harbour and West Shore Sites**

Process	Description
Sludge screening	Sludge screening building will screen raw sludge to remove debris and hair that plug downstream pipes, damage equipment, and accumulate in process tanks. If the biosolids facility is located adjacent to the liquids facility, raw sludge will be transferred from the primary clarifiers. If the biosolids facility is located remotely from the liquids facility, raw sludge could be delivered by pipeline.
Co-digestion substrate receiving	A co-digestion substrate receiving building will receive, screen, and preheat FOG and other substrates received from haulers. The substrates will be metered from this building directly into the digestion process. It is assumed that if food waste is co-digested, food waste pre-processing facilities would be located off site at Hartland landfill.
Thickening	Raw sludge will be thickened using gravity belt thickeners prior to digestion. The thickeners and associated equipment will be located in the liquids treatment facility. Following thickening and screening, thickened sludge will be transferred to the sludge blend tank.
Sludge blending	The sludge blend tank will store thickened sludge prior to digestion. Thickened sludge will be mixed and metered into the anaerobic digestion process.
Digestion	Anaerobic digesters operating at thermophilic temperatures will produce stabilized Class A biosolids and biogas. The digester control building will contain equipment for heating, mixing, feed, and withdrawal of sludge.
Sludge storage	Following anaerobic digestion, digested sludge will be stored in the sludge storage tank prior to dewatering.
Dewatering	The dewatering building will include centrifuges that produce cake of approximately 24% to 30% solids content. Cake will either be sent to the dryers or stored in cake hoppers for loading into sludge hauling trucks.
Thermal solids drying	Dewatered cake will be dried in a low temperature belt dryer to a solids content of approximately 95%. The dryer heat is supplied by high temperature heat pumps ¹
Energy recovery and gas treatment	Biogas produced from the thermophilic anaerobic digestion process will be scrubbed and compressed to natural gas quality. The energy building will house an emergency generator, backup boiler for plant heating, and gas booster blowers. Waste gas will be burned in the waste gas incinerator.
Odour control	Odours from the biosolids facility will be treated in an odour control biofilter using engineered media.

Note:

1. If the WTE for biosolids is implemented at the biosolids treatment facility, heat for the drying process can be supplied from the non-condensing steam turbine.

Biosolids derived from the process train described above are suitable for a variety of beneficial uses described in Section 3. Potential integration options with solid waste are described in Section 4. Options that deviate from this process train include thermal destruction and energy recovery from raw sludge at the WWTP, or mixed with solids waste at a separate facility. In these cases, digestion and gas utilization are eliminated from the process train.

7.3 DIGESTION AND DRYING: PROCESS DESIGN CRITERIA

The design data for a generic biosolids treatment facility processes are listed in **Table 7.2**.

CAPITAL REGIONAL DISTRICT

Core Area Wastewater Treatment Program

Biosolids Management Plan

Table 7.2 – Design and Operating Criteria for the Biosolids Treatment Facility

Parameter	Option 1A Upper Victoria Harbour	Option 1A West Shore
Sludge Screening		
Number of screens	2	1
Capacity, each, m ³ /day	2,200	2,200
Capacity, each, m ³ /day	2,200	2,200
Co-Digestion Substrate Receiving Facility		
Number of screens	1	1
Capacity, each, m ³ /day	2,200	2,200
Number of storage tanks	2	2
Tank volume, each, m ³	28	7
Anaerobic Digestion and Performance Criteria		
Digesters		
Total firm capacity, m ³ (with one offline)	10,800	2,700
Number of digesters	4	2
Capacity each, m ³	4,100	2,700
Inside diameter, m	22.9	20
Side water depth, m	10	9
Cover type	Fixed cover	Fixed cover
Bottom configuration	Cone-bottom	Cone-bottom
Operating mode	Class A TPAD	Class A TPAD
Digester mixing, type	Draft tube, mechanical mixers	Draft tube, mechanical mixers
Number of mixers per digester	4	3
Mixer capacity, L/min each	30,000	30,000
Digester heating type	Spiral hot water/sludge HEX	Spiral hot water/sludge HEX
Sludge cooling/heat recovery system	Sludge to water to sludge	Sludge to water to sludge
Transfer system between digestion stages	Standpipes and pump transfer	Standpipes and pump transfer
Digestion Operation/Performance Criteria		
Volatile solids load, peak 14-day, three tanks online, kg-VS/m ³ /day	4.8	4.8
Volatile solids load to first-stage thermo, peak 14-day, two tanks online, kg-VS/m ³ /day	4.8	4.8
Total solids loading		
At avg., kg-TS/day (kg-TS/day with co-digestion)	23,400 (29,500)	6,000 (7,200)
At peak 14-day, kg-TS/day (kg-TS/day with co-digestion)	32,800 (36,800)	8,400 (9,200)
Volatile solids reduction	60%	60%
Solids retention time, days at peak 14-day, three tanks online	15	15

CAPITAL REGIONAL DISTRICT

Core Area Wastewater Treatment Program

Biosolids Management Plan

Table 7.2 – Design and Operating Criteria for the Biosolids Treatment Facility

Parameter	Option 1A Upper Victoria Harbour	Option 1A West Shore
Thermophilic temp, °C (°F)	~55 (131)	~55 (131)
Mesophilic temp, °C (°F)	~38 (100)	~38 (100)
Sludge Blend and Storage Tanks		
Storage tank volume, m ³	440	-
Sludge blend tank volume, m ³	440	-
Centrifuge Dewatering System		
Centrifuges		
Number	3	2
Capacity each, m ³ /hr	20	10
Capacity each, l/min	86	43
Type of machine	High-solids	High-solids
Centrifuge feed pumps, number	4	3
Centrifuge feed pump capacity each, l/min	325	165
Bridge crane, number	1	1
Feed concentration, % solids	~2.3	~2.3
Cake content, % solids	24	24
Solids capture, %	95	95
Polymer dose expected, kg/tonne DS	~14	~14
Odour control		
	FA contain in centrate hopper/biofilter	FA contain in centrate hopper/biofilter
Foul air capacity, m ³ /hr	120	40
Cake handling and loadout		
Classifying screw conveyors, number	3	2
Cake holding hoppers, number	2	1
Capacity each, m ³	105	55
Cake holding time, days (at avg.)	2	2
Number of truck loadout bays	1	1
Truck weigh scale, number	1	1
Odour control		
	FA contain/biofilter	FA contain/biofilter
Foul air capacity, m ³ /hr	1200	600
Thermal Solids Drying		
Digested solids		
At avg., kg/day dry	12,700	3,300
At peak 14-day, kg/day dry	17,000	4,200
Solids dryers		
Number of units	1	1
Capacity, each, kg/day dry	15,000	3,800
Water removal, each, kg/day	46,700	11,700
Wet cake contents, % solids	24%	24%
Dry cake contents, % solids	95%	95%

CAPITAL REGIONAL DISTRICT

Core Area Wastewater Treatment Program
Biosolids Management Plan

Table 7.2 – Design and Operating Criteria for the Biosolids Treatment Facility

Parameter	Option 1A Upper Victoria Harbour	Option 1A West Shore
Pneumatic conveyance		
Number	1	1
Capacity, each, kg/day dry	15,000	3,800
Dry product storage silo		
Number	4	2
Holding capacity, days	4	4
Volume, each, m ³	30	30
Wet cake silos		
Number	2	1
Holding capacity, days	1	1
Volume, each, m ³	30	15
High temperature heat pumps		
Number	6	2
Heat output, MJ/hr, each	1055	1055
Energy Building		
Boiler		
Number of units	1	1
Type of boiler	Firetube	Firetube
Capacity, kW	1,500	500
Essential services generator		
Number of units	1	1
Type of generator	Diesel	Diesel
Capacity, kW	300	300
Diesel storage tank		
Number of tanks	1	1
Type	Double-walled aboveground fuel storage tank	Double-walled aboveground fuel storage tank
Capacity, m ³	12	12
Gas blowers		
Type, number of units	Centrifugal, 2	Centrifugal, 2
Capacity, N m ³ /hr	800	200
Gas Systems		
Lower heating value, MJ/N m ³ gas	20.9	20.9
Annual avg. gas production, N m ³ /day	14,900	3,600
Peak 14-day gas production, N m ³ /day	18,900	4,700
Gas pressure range from digestion	12 to 20 inches wc	12 to 20 inches wc
Energy values		
Annual avg. gas energy, MW/day	3.6	0.9
Peak 14-day gas energy, MW/day	4.6	1.1
Lower heating value, MJ/N m ³ gas	20.9	20.9
Gas upgrading		

CAPITAL REGIONAL DISTRICT

Core Area Wastewater Treatment Program

Biosolids Management Plan

Table 7.2 – Design and Operating Criteria for the Biosolids Treatment Facility

Parameter	Option 1A Upper Victoria Harbour	Option 1A West Shore
Capacity, N m ³ /hr	800	200
Sweetening (H ₂ S removal)		
Type of system	Sulfatreat	Sulfatreat
Number of vessels	2	1
Compression		
Type, number	Flooded screw, 2	Flooded screw, 2
Capacity, kW	120, 100	30, 25
Scrubbing		
Type of system	Pressure swing adsorption	Pressure swing adsorption
Number of stages	2	2
Exhaust gas blower		
Type, number	Vacuum pump, 1	Vacuum pump, 1
Capacity kW, each	20	5
Flares		
Number	2	1
Type of flares	Gas assisted/Enclosed	Gas assisted/Enclosed
Capacity, each, N m ³ /hr	1,500	1,500
Odour Control		
Biofilter		
Footprint, m ²	970	490
Capacity, N m ³ /hr	1,450	730

The generic biosolids digestion and drying treatment facility will produce a dried product that has many potential recycling options including fossil fuel substitute. Refinements to this assumption include potential utilization of dewatered or dried Class A biosolids for topsoil blending, reclamation, and biomass (e.g., willow coppice) production at a dedicated site. As described previously, the option to forgo digestion and gas sale in favour of thermal combustion for energy recovery (WTE) is also considered.

For the WTE options with anaerobic digestion the digestion system could be reduced in size because the redundancy requirements are largely eliminated. WTE options located at the treatment plant could eliminate the heat pumps if a non-condensing turbine is used and the steam is used as the heat source for drying.

7.4 DIGESTION AND DRYING: FACILITY LAYOUTS

A generic layout was developed for the biosolids treatment facility at the **Upper Victoria Harbour** site, which can be applied to meet the requirements of several of the primary solids management alternatives. In addition, this layout can be reduced in size to meet the needs of the **West Shore** facility. The generic biosolids facility is shown in **Figure 7.1**.

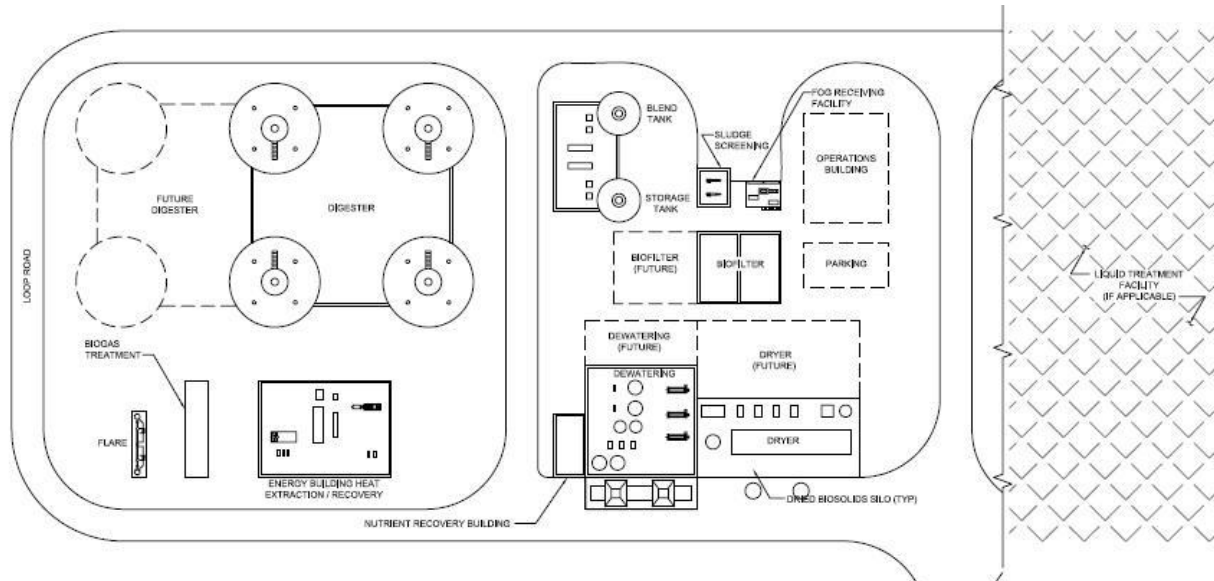

Figure 7.1 – Regional Biosolids Facility Layout

The operations building and parking facility are shown in **Figure 7.1** with dashed lines; these structures would be required only if the biosolids treatment facility is located separate from the liquids stream facility. If the biosolids treatment facility is located at a separate site, it is assumed that these structures would be required.

The West Shore facility will receive approximately 25% of the load of the Upper Victoria Harbour facility. The smaller facility will have a reduced layout relative to the generic site. The major processes and equipment are listed in **Table 7.2**. The site layout will be reduced by the following equipment:

- Two digesters will be removed
- Building sizes will be reduced.

The overall site layout for biosolids treatment will be reduced by approximately 30%. The West Shore facility will be co-located with the liquids stream facilities, therefore an operations building and parking facility are not required exclusively for biosolids.

7.5 WTE FACILITY FOR BIOSOLIDS AT THE WWTP SITE

Under this option, a FBI would be used to thermally destroy the biosolids and provide steam for power generation. This alternative assumes the WTE facility would be sized exclusively for biosolids and would be located at the WWTP site. An FBI can receive either digested or raw biosolids. Combustion of digested solids in a FBI does not require modifications to the plant processes or layout, with the exception of locating the FBI on the site. Solids will be digested and dried prior to combustion in the FBI.

If raw biosolids were dried and combusted in an FBI, the digestion process would not be required. Selection of this alternative would eliminate several processes, including anaerobic digestion, gas handling, FOG receiving, sludge screening, and the sludge blend tank.

An FBI size should be designed based on peak day solids loading. Energy from the combustion process is recovered in a steam turbine system. A full condensing turbine would provide about 19% electrical conversion efficiency. If a non-condensing steam turbine is used, steam at 2 bar and 120°C would exit the turbine and could provide heat for drying the biosolids. While this would reduce the power generated by the steam turbine-generator (10% electrical conversion efficiency), the heat pumps could be eliminated as the heat source for drying. The avoided electrical load for the heat pumps would provide a net electrical benefit to the facility. If the WTE facility is selected, it is recommended to use a non-condensing steam turbine and use the steam as the heat source for drying.

A WTE facility would be designed based on availability of solids from the biosolids treatment facility (Upper Victoria Harbour and West Shore). The quantity of biosolids available for a WTE facility is approximately 6,100 tonnes/year of digested solids and 11,200 tonnes/year of raw solids. **Table 7.3** summarizes the available solids.

Table 7.3 – Potential Fuel Sources for a WTE Facility Using Biosolids

Solids Available for a WTE Facility	Tonnes/Year
Dried (95%), digested solids ¹	6,100
Dried (95%), raw solids ¹	11,200

Note:

1. Solids from Upper Victoria Harbour and West Shore facilities.

CAPITAL REGIONAL DISTRICT

Core Area Wastewater Treatment Program

Biosolids Management Plan

This type of WTE system has been used in the scenario development for managing dried biosolids. Furthermore, the base facility discussed below, assumes the development of a single-unit plant, capable of managing all of the raw or digested biosolids streams. Key aspects of the FBI concept plant used as the basis for assessing the biosolids management for CRD are outlined below in **Table 7.4**.

Table 7.4 – Key Aspects of the Biosolids FBI WTE Concept Plant

Aspect	Details
Technology	Circulating fluidized bed application to a dried biosolids feed stream. System can accept dried raw or digested biosolids streams.
Earliest Implementation Date	2016, it generally takes a minimum of 5 years to complete approvals/permitting process, procurement, construction and commissioning.
Capacity, Expandability	Base facility: 6,100 tpy for digested, thermally dried biosolids; 11,200 tpy for undigested (raw), thermally dried
Services/Utilities	Site needs to be supplied with natural gas, electricity, and water.
Number of Units	Base facility: One operating unit
Location	Upper Victoria Harbour
Electricity Generation	Based on digested solids and characteristics: Average net energy production 443 kWh/tonne Biosolids waste energy content 18,000 MJ/tonne Plant heat rate 40.6 MJ/kWh Plant capacity 0.37 MW
Combined Heat and Power (CHP)	Part of the base facility
Emissions Limits	Conceptual design to meet Canadian Requirements and the more stringent European Union (EU) EFW systems and publications (EC 2006)
Auxiliary Fuel	Requires natural gas for startup (heating of fluidized bed)
Odour and Dust Control	Combustion air can be drawn from various areas requiring odour control to reduce or eliminate odour control equipment requirements
Bottom Ash Handling	Bottom ash removed from bottom of fluid bed for disposal
Power Island	Non-condensing steam turbine generator
Air Pollution Control	Bag house, wet scrubber, lime/alkali injection
Fly Ash Handling	Treated/stabilized prior to landfill disposal
Plant Uptime	85% to 95%
Feed Buffer	12–24 hours capacity from drying
Monitoring	Continuous emissions monitoring (CEMS) for all major operating and air parameters
Water Demand and Effluent	Plant cooling provided by re-circulated cooling water system Process water for wet scrubber

7.6 WTE FACILITY FOR BIOSOLIDS AND MSW AT HARTLAND LANDFILL SITE

A mass burn facility can receive both digested or raw biosolids and MSW. Use of digested solids does not require modifications to the WWTP processes or layout, and dried solids would be hauled to the WTE facility. If raw biosolids are used in the WTE facility, the biosolids treatment facility will require modifications, requiring removal of several processes including: anaerobic digestion, gas handling, FOG receiving, and sludge screening.

A WTE facility would be designed based on availability of MSW and peak 14-day solids production from the biosolids treatment facility (Upper Victoria Harbour and West Shore) and. The quantity of solids available for a WTE facility is approximately 6,100 tonnes/year of digested solids and 11,200 tonnes/year of raw solids. Over 200,000 tonnes/year of MSW may be available as a fuel for a WTE facility. **Table 7.5** summarizes the available solids.

Table 7.5 – Potential Fuel Sources for a WTE Facility

Average Solids Available for a WTE Facility	Wet Tonnes/Year
Dried (95%), digested solids ¹	6,100
Dried (95%), raw solids ¹	11,200
CRD MSW ²	110,000
Nanaimo MSW ³	70,000
Cowichan Valley MSW ³	28,000

Notes:

1. Solids from Upper Victoria Harbour and West Shore facilities.
2. CRD currently generates 160,000 tonnes/year, but removal of recyclable products (paper, cardboard, food waste, etc.) will reduce the quantity.
3. Nearby district that may consider disposal of MSW at a WTE facility.

The design required for an integrated MSW/Biosolids WTE facility for CRD would be driven by the MSW material stream, which would make up 95% or more of the feedstock for a 200,000 tpy facility. At a conceptual level, there are no key design differences that may be driven by the differences between the two potential biosolids feedstock (dried raw or digested biosolids). Due to the large quantity of MSW and the minimal impact of dried biosolids, it is recommended that for the purpose of identifying and comparing integrated MSW/Biosolids management scenarios with others proposed for the management of biosolids, that the concept plant be a mass burn, moving grate system.

CAPITAL REGIONAL DISTRICT

Core Area Wastewater Treatment Program Biosolids Management Plan

This type of WTE system has been used in the scenario development as it is the technology for which we have the most comprehensive dataset including costs, and as it is a proven approach for managing both MSW and biosolids streams. Furthermore, the base facility discussed below, assumes the development of a single-unit plant, capable of managing all of the post-diversion residual waste generated in the CRD and potentially all of the raw or digested biosolids streams.

Should it be determined that the preferred option for biosolids management for CRD, includes an integrated MSW/Biosolids WTE plant, there would be value in allowing for the following to be considered during the transition from concept to implementation:

- **Type of WTE Technology** – While mass burn moving grate systems are the most proven WTE approach for managing MSW and biosolids, there are other facilities and systems that are currently in development or completing commissioning, which could meet the standard of being a “proven” technology within a few years. It is recommended that if implementation of a WTE is considered, that the procurement process allow for a qualifications stage that would allow for WTE technology vendors to provide technical, operational and financial information that would allow CRD to determine if they offer a proven approach.
- **Size of Facility** – the concept plant is based on very preliminary assumptions regarding the potential post-diversion waste stream that may be generated in the CRD. Assessment of future diversion system performance will be required, which may confirm the need for more or less capacity to serve CRD’s needs. Furthermore, it may be determined that partnerships or other contractual arrangements with other jurisdictions, could result in increasing the viability of a larger plant. It is recommended that prior to any procurement process, that detailed investigation of both the projected MSW stream and partnership opportunities be undertaken.
- **Staged Implementation** – there may be value in considering the development of a multi-unit facility over a more extended time frame, particularly if it appears that the waste generation estimates for CRD do not support a 100,000-tpy facility over the longer term. There are alternative designs for smaller scale WTE plants that could suit the needs for managing a portion of the CRD MSW and biosolids that would allow for phasing in of a multi-unit plant. It is recommended that if implementation of a WTE is considered, that the procurement process allow for vendors to identify the potential for their technology to offer a single or multiple unit approach and to identify the economies of each approach.

Consideration of a staged approach to integrating biosolids and MSW may prove to be more financially viable for funding a WTE component of the Core Area Wastewater Treatment Project. It could allow the development of additional thermal processes into the ultimate scheme as the track record of emerging processes improves (e.g., gasification). Key aspects of the EFW concept plant used as the basis for assessing the integration of MSW and biosolids management for CRD are outlined below in **Table 7.6**.

CAPITAL REGIONAL DISTRICT

Core Area Wastewater Treatment Program

Biosolids Management Plan

Table 7.6 – Key Aspects of the Mass Burn WTE Concept Plant

Aspect	Details
Technology	Mass burn moving grate application to an MSW feed stream with no pretreatment. System can accept dried raw or digested biosolids streams. Technology has ability to accept variations in waste stream with minimal impact.
Earliest Implementation Date	2020, it was assumed that 5 years would be required to evaluate WTE for MSW, agree on direction, select a site, and secure funding. In addition, it generally takes a minimum of 5 years to complete approvals/permitting process, procurement, construction and commissioning.
Capacity, Expandability	Base facility: 210,000 tpy
Services/Utilities	Site needs to be supplied with natural gas, electricity at 13.8 kV, potable water, sanitary sewer and cooling water.
Number of Units	Base facility: Two 105,000-tpy operating units
Location	Hartland landfill site
Electricity Generation	Based on post-SSO waste composition and characteristics: Average net energy production 770 kWh/tonne MSW waste energy content 13,000 MJ/tonne Plant heat rate 16.9 MJ/kWh Plant capacity 17 MW
Combined Heat and Power (CHP)	Base facility: not considered. CHP contingent upon location.
Emissions Limits	Conceptual design to meet European Union (EU) EFW systems and publications (EC 2006)
Auxiliary Fuel	Requires natural gas for startup and temperature control
Odour and Dust Control	Combustion air will be drawn from unloading and fuel storage area. This acts as primary control for odours and dust from incoming waste.
Bottom Ash Handling	Bottom ash quenched, quench water recycled. Bottom ash screened and magnetically separated to remove ferrous and non-ferrous metals with 80% recovery rate for ferrous metals and 60% recovery rate for non-ferrous.
Power Island	Two single casing steam turbine generators, mechanical draft cooling tower
Air Pollution Control (APC)	Semi-wet scrubber, lime/alkali injection, PAC injection, bag house
Fly Ash Handling	Treated/stabilized prior to landfill disposal
Plant Uptime	85% to 95%
Feed Buffer	5 days capacity, fuel bunker of approximately 9,000 cubic metres
Monitoring	CEMS for all major operating and air parameters
Water Demand and Effluent	Plant cooling provided by re-circulated cooling water system Process water for wet APC Wastewater from plant processes used to quench bottom ash and reused, close to zero discharge of waste water.

7.7 WTE ALTERNATIVE LAYOUT MODIFICATIONS

The generic site layout shown in **Figure 7.1** can be modified to meet the requirements of the primary solids management alternatives. **Table 7.7** describes the modifications to the site layout that are required to meet the objectives of each alternative.

Table 7.7 – Biosolids Treatment Facility Layout Alternatives

WTE Alternative	Modifications Required to Generic Site Layout
1. Combustion of raw, dried solids at the biosolids treatment facility	Combustion of raw dried solids in an FBI located at the biosolids treatment facility would not require anaerobic digestion or the associated processes. The generic layout would be modified to accommodate this process through removal of the anaerobic digesters, energy recovery and gas handling, sludge screening, and FOG receiving processes. The site would require the addition of a new FBI.
2. Combustion of digested, dried biosolids at the biosolids treatment facility	The generic layout would be modified to accommodate combustion of digested, dried biosolids through the addition of a FBI facility on site.
3. Combustion of raw, dried biosolids at a facility located near Hartland landfill	The generic layout would be modified to accommodate this process through removal of the, anaerobic digesters, energy recovery and gas handling, sludge screening, and FOG receiving processes. The dried biosolids would be trucked to a WTE facility near the Hartland landfill and incinerated with MSW in a mass burn incinerator. The biosolids dryer could alternatively be located at the Hartland landfill to utilize heat from the WTE facility (at the expense of some electricity production).
4. Combustion of digested, dried biosolids at a facility located near the Hartland landfill	Digested and dried biosolids would be trucked to a WTE facility located near the Hartland landfill and incinerated with MSW in a mass burn incinerator.

7.8 CONSIDERATION OF PHASING OF WTE FACILITIES

With alternatives that include WTE facilities for co-combustion of biosolids and municipal solid waste at Hartland landfill, the total cost, including building a full regional WTE facility in the time frame of this wastewater program would likely be prohibitively expensive. To evaluate that consideration further, an analysis of the costs and benefits of building a small first phase WTE facility at Hartland landfill was completed and is presented in Appendix B.

7.9 CONSIDERATION OF PHASING OF BIOSOLDS HANDLING FOR EAST SAANICH PLANT

Current planning is underway with respect to phasing of the various wastewater treatment facilities. One option is to begin the construction and operation of the East Saanich plant ahead of other facilities. No biosolids facilities are planned for East Saanich as its biosolids will be

transported to the Upper Victoria Harbour biosolids facility for treatment. If the East Saanich facility is constructed ahead of other biosolids facilities, a temporary system will have to be planned to handle East Saanich biosolids until the permanent facilities at the Upper Victoria Harbour site are operational. One alternative would be install temporary dewatering units at East Saanich and haul the dewatered raw biosolids to Hartland landfill for disposal. Biosolids could be lime stabilized prior to landfilling. Alternatively, there may be capacity in the lime stabilization facilities at the Saanich Peninsula site to handle increased load from East Saanich. If that were the case, dewatered solids could be hauled to Saanich Peninsula site for stabilization prior to hauling to Hartland landfill or marketing along with the plant's PenGrow product.

7.10 CONSIDERATION OF INTEGRATION WITH SAANICH PENINSULA AND SOOKE WASTEWATER TREATMENT PLANTS

Currently the Saanich Peninsula and Sooke wastewater treatment plants combined produce approximately 3,500 wet tonnes per year of lime stabilized biosolids cake. Some of this is marketed as PenGrow and some is disposed of in the Hartland landfill. In early years of the operation of the new biosolids facilities there may be capacity provided for future growth that could be available to digest raw biosolids from these two facilities. These solids would represent less than 5% of the planned load on the biosolids facilities. These loads could be accommodated in the capacity reserved for co-digestion substrates or a slight additional capacity could be added at marginal cost to permanently accommodate them. It should be noted that solids fed to the digesters will be thickened raw sludge at a solids concentration of from 5 to 6%. For small volumes, as that from Sooke and Saanich Peninsula, a somewhat thicker material could be accommodated, perhaps up to 10%. That material would have to be trucked to the new CRD biosolids facilities for processing.

7.11 CONSIDERATION OF ALTERNATIVE OPTIMIZATION AND REFINEMENTS

In the course of preparing this report, assumptions had to be made with respect to constraints posed for each alternative and judgments made as to the optimum configuration for facilities. As the CRD wastewater program develops, some constraints will be relieved (i.e., sites selected) and others may become more significant. At that time, refinements can be made in all of the options discussed to reorient or resize facilities or consider adjustments in locations of facilities. As an example, if a suitable Upper Victoria Harbour biosolids site is selected, it may be large enough to provide space for the West Shore biosolids and allow the potential for lowering costs by consolidating treatment onto a single site. Another example is that if WTE facilities are selected at Hartland, locating the biosolids dryers at Hartland may prove more beneficial if the benefit from the use of waste heat from WTE offset the cost and impacts from the trucking greater volumes of dewatered cake (versus dried product) to Hartland. Analyses of these types of refinements will be made and appropriate adjustments made to the program as it progresses.

Section 8 Carbon Footprint Analysis

8.1 PURPOSE OF ANALYSIS

The province of British Columbia is aggressively pursuing reductions in GHG emissions. In 2007, the Greenhouse Gas Emissions Target Bill 44 established the following emissions targets:

- By 2020 and for each subsequent calendar year, BC GHG emissions will be at least 33% less than the level of those emissions in 2007.
- By 2050, and for each subsequent calendar year, BC GHG emissions will be at least 80% less than the level of those emissions in 2007.

In addition to legislative targets the provincial government has passed the revenue-neutral carbon tax, created an emissions trading system, and mandated a carbon-neutral public sector.

According to the 2007 BC GHG Inventory report, 0.1% of provincial emissions are from wastewater treatment operations. If managed appropriately, the biosolids program is one way in which a municipality can offset operation emissions and accrue carbon credits. The credits will enable a municipality to achieve a net carbon footprint of zero more easily. In addition, as the GHG offset market becomes established, operations that generate offsets could generate revenue.

As a result of these influencing factors, a carbon footprint analysis was performed to compare the carbon debits and credits of the biosolids management options.

A carbon footprint measures the amount of GHG emitted (debit) or stored (credit) as a result of a process or activity. To account for direct and indirect emissions separately, GHG inventory protocols categorize direct and indirect emissions into “scopes” as follows:

- **Scope 1:** All direct GHG emissions (with the exception of direct CO₂ emissions from biogenic sources)
- **Scope 2:** Indirect GHG emissions associated with the consumption of purchased or acquired electricity, steam, heating, or cooling
- **Scope 3:** All other indirect emissions not covered in Scope 2, such as emissions resulting from the extraction and production of purchased materials and fuels, transport-related activities in vehicles not owned or controlled by the reporting entity (e.g., employee commuting), outsourced activities, waste disposal, etc.

CAPITAL REGIONAL DISTRICT

Core Area Wastewater Treatment Program Biosolids Management Plan

This analysis included Scope 1 and 2 emissions as well as a limited number of Scope 3 emissions associated with the biosolids use alternatives. **Figure 8.1** illustrates the emission scope categories.

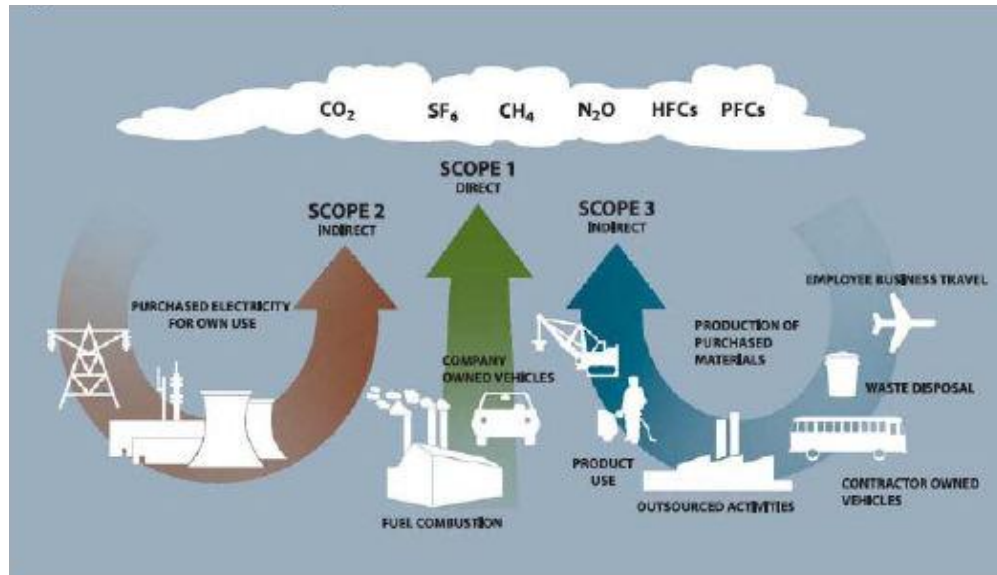

Figure 8.1 – Emission Scope Categories

(Source: WRI/WBCSD GHG Protocol Corporate Standard, Chapter 4 [2004])

8.2 BASIS OF METHODOLOGY

Carbon footprint analysis is a relatively new method of quantifying environmental impacts; therefore, analysis methodologies can vary widely. Investigations of relevant scientific literature were conducted to elucidate the most appropriate carbon accounting and emissions factors. The CCME recently published the Biosolids Emissions Assessment Model (BEAM): A Method for Determining Greenhouse Gas Emissions from Canadian Biosolids Management Practices (CCME 2009). BEAM was evaluated and consistent methodology and emissions factors were used for this analysis as appropriate.

The three GHGs relevant to biosolids management are carbon dioxide (CO₂), methane (CH₄), and nitrous oxide (N₂O). The direct and indirect emissions and offsets of these GHGs are included in the carbon footprint analysis.

- **Carbon dioxide** – CO₂ enters the atmosphere by burning carbonaceous substances such as fossil fuels (oil, natural gas, and coal), solid waste, and trees, and as a by-product of chemical reactions (e.g., the manufacture of cement). CO₂ is also removed from the atmosphere (or sequestered) when it is absorbed by plants or stored in the soil as part of the biological carbon cycle.

CAPITAL REGIONAL DISTRICT

Core Area Wastewater Treatment Program Biosolids Management Plan

- **Methane** – CH_4 is emitted during the production and transport of coal, natural gas, and oil. CH_4 is also produced from the anaerobic digestion of waste at wastewater treatment facilities, by livestock, and by the decay of organic waste in MSW landfills.
- **Nitrous oxide** – N_2O is emitted by agricultural and industrial activities, combustion of fossil fuels and solid waste, and through secondary biological nutrient removal wastewater treatment processes.

In addition to the above three GHGs, hydrofluorocarbons (HFCs), perfluorocarbons (PFCs), and sulphur hexafluoride (SF_6) are also GHGs regulated under the Kyoto Protocol. Estimates of emissions of these GHGs associated with the alternative options are not considered significant and are generally not currently available; therefore, these GHGs are not included in the analysis.

GHG emissions can occur from anthropogenic or biogenic sources. Anthropogenic emissions are produced by human activities that remove sequestered carbon from the earth's crust and release it to the atmosphere (e.g., through the burning of fossil fuels). Biogenic carbon occurs in plants and animals that intake and dispense of carbon cyclically. Biogenic sources do not increase the amount of GHGs in the atmosphere, but merely represent the "natural" cycling of carbon. Therefore, emissions of biogenic CO_2 are generally not accounted for in GHG inventories for wastewater treatment. In fact, biogenic carbon sources can be considered an offset when utilized in place of an anthropogenic source (for example, when using biogas from a wastewater treatment process as a fuel source in place of natural gas).

Once GHGs are emitted into the atmosphere, they absorb and re-radiate heat with varied levels of effectiveness. The global warming potential (GWP) quantifies the contribution of each gas over a specific time interval in terms of CO_2 . The GWP of CO_2 , by definition, is 1. The 100-year GWP values of CO_2 , CH_4 , and N_2O are shown below, based on the 2007 British Columbia Greenhouse Gas Inventory report:

- CO_2 GWP = 1 equivalent kg of CO_2
- CH_4 GWP = 21 equivalent kg of CO_2
- N_2O GWP = 310 equivalent kg of CO_2

Table 8.1 summarizes the emissions factors used to calculate the GHG emissions associated with the alternatives. The results of this carbon footprint analysis are reported in equivalent tonnes of CO_2 .

CAPITAL REGIONAL DISTRICT

Core Area Wastewater Treatment Program
Biosolids Management Plan

Table 8.1 – Greenhouse Gas Emissions Factors, Conversion Factors, and Assumptions for Analysis

Component	Value	Units	Source
Energy Sources			
Diesel	0.002637	tonneCO ₂ /L	Brown, Biocycle 2004; EIA
Electricity	0.000022	tonneCO ₂ /kWhr	BC Hydro, 2003
Natural gas	0.001901	tonneCO ₂ /m ³	Abu-Orf et al. 2008; EIA; CCME 2009
Coal	0.09414	tonneCO ₂ /GJ	Abu-Orf et al. 2008; EIA
Process Chemicals			
Lime production	3.6	tonne CO ₂ /tonne of lime	CCME, 2009; Murray et al. 2008
Dewatering polymer production	22.9	tonne CO ₂ /tonne of polymer	CCME, 2009
Greenhouse Gases			
Methane			
Global warming potential	21		CCME, 2007
Gas scrubbing fugitive	1	% of total biogas	CCME, 2009
Composting	0-2.5	% of initial C	Brown et al. 2008
Combustion of solids	0.0011155	tonne CO ₂ /tonne solids burned	CCME, 2009
Land application	negligible		CCME, 2009
Landfill fugitive	0.067	tonne CH ₄ emitted/ tonne dry solids	CCME, 2009
Nitrous oxide			
Global warming potential	310		CCME, 2009
Composting fugitive	0-1.5	% of initial N	Brown et al. 2008
Combustion of solids	N ₂ O = 4% total N*η; η = 161.3 - 0.140*Tf where Tf = max. freeboard temp. in °K		
Land application	0.75	% of initial N	CCME, 2009
Landfill fugitive	1.5	% of initial N	CCME, 2009

CAPITAL REGIONAL DISTRICT

Core Area Wastewater Treatment Program
Biosolids Management Plan

Table 8.1 – Greenhouse Gas Emissions Factors, Conversion Factors, and Assumptions for Analysis

Component	Value	Units	Source
Land Application Process Emissions			
Tractor fuel use	25	L-diesel/hr	CCME, 2009
Time to apply	3	loads/hr	CCME, 2009
Size of loads	13	m ³	CCME, 2009
Emissions Offsets for Biosolids Land Application			
Carbon sequestration for agriculture	0.25	tonnes CO ₂ /dry tonne applied	CCME, 2009
Carbon sequestration for mine reclamation	0.875	tonnes CO ₂ /dry tonne applied	CCME, 2009
Avoidance N fertilizer	0.004	tonne/kg N	ROU, 2006
Avoidance P fertilizer	0.002	tonne/ kg P	ROU, 2006
Soil Amendments			
Blending soil product	2.50	L fuel/tonne product	CCME, 2009
Aerated static pile power for aeration	917501	kw-hr/yr	Wilson & Meloy, personal communication
Grinding, mixing, setting up and breaking down piles	5.8	L of fuel/tonne product	Brown et al. 2008
Heating Value of Alternative Fuels			
Dried digested solids	18	GJ/tonne solids	CRD, 2008
Raw sludge	22	GJ/tonne solids	CRD, 2008
Hybrid poplar	19.63	GJ/tonne dry matter	Vande Walle et al. 2007
Net energy produced from wood biomass	61.7	GJ/ha-yr	Vande Walle et al. 2007
MSW + raw biosolids	13.9	GJ/tonne material	Ralph, personal communication
MSW + digested biosolids	13.3	GJ/tonne material	Ralph, personal communication

CAPITAL REGIONAL DISTRICT

Core Area Wastewater Treatment Program
Biosolids Management Plan

Table 8.1 – Greenhouse Gas Emissions Factors, Conversion Factors, and Assumptions for Analysis

Component	Value	Units	Source
Energy Requirements of Combustion			
Fluidized bed			
Biosolids processing	284	kWhr/tonnedrysolids	CCME, 2009
Energy required to remove water from sludge	4.5	GJ/tonne water	CCME, 2009
Natural gas fuel consumption	605	m ³ /tonne biosolids-dry	CCME, 2009
Conversion of energy in biosolids to usable energy	0.8	% of biosolids energy value	CCME, 2009
Cement kiln			
Ash supplement offset	1.2675	kg CO ₂ /dryMg biosolids	Murray et al. 2008
Mass burn			
Lime addition	0.03276	tonne CO ₂ /tonne MSW	Genivar, 2009
Ammonia	0.0005	tonne CO ₂ /tonne ammonia	Genivar, 2009
Energy consumption	0.052	GJ/tonne MSW	Genivar, 2009
GHG CO ₂ equivalent emissions–therm. treatment fac.	0.1966	tonnes CO ₂ /tonne-yr	Genivar, 2009
Process waste			
Bypass waste	1.5	%	Genivar, 2009
Bottom ash	21.0	%	Genivar, 2009
Fly ash	6	%	Genivar, 2009
Landfill			
Mixing (diesel use)	1.036	L/tonne waste landfilled	Baly & Eriksson (2203) cited in Lou and Nair (2009)
Carbon sequestration	0.08	tonneCO ₂ /tonne biosolids	Beecher, 2008
Transportation			
Heavy-duty truck (diesel use)	2.13	km/L	CCME, 2009
Heavy-duty vehicle capacity	27.22	tonne/load	Kruse et al. 2007
Transport by barge	222.13	tonne-km/L fuel	Kruse et al. 2007
Barge capacity	1587.57	tonne/load	Kruse et al. 2007

8.3 ASSUMPTIONS

The results in this analysis are based on preliminary design assumptions for biosolids management alternatives and are subject to refinement after determination of final design solids characteristics and further analysis of design options.

This analysis is based on the following guiding assumptions:

General Assumptions

- Each alternative is analyzed as if receiving the entire amount of biosolids produced in the design year 2030.
- All of the alternatives, with the exception of WTE for raw sludge and landfill, include utilization of 6,120 tonnes of digested thermally dried biosolids annually. The WTE for the raw sludge alternative includes utilization of 12,730 tonnes of raw thermally dried biosolids annually. The landfill alternative includes utilization of 24,224 tonnes of digested dewatered cake annually.
- Embodied emissions (e.g., emissions associated with the construction of buildings and machinery used in the biosolids management alternatives) are not included in this analysis.
- A private hauler is used to transport the biosolids for all alternatives.
- Methane capture at the landfill is assumed to be 20%.

Fertilizer and Soil Amendment Alternatives

- The fertilizer value of the biosolids is based on the 2008 biosolids characteristics from the Metro Vancouver Annacis WWTP.
- Topsoil blend is 2 parts thermally dried product: 2 parts sawdust: 1 part sand.
- Compost blend is 2 parts sawdust: 1 part thermally dried product.
- Wood chips may be diverted from the landfill to supplement the compost blend. However, as this is not the major source of woody material, no carbon credit was taken for wood diversion.
- The thermally dried fertilizer product will be handled by private soil manufacturers which will haul the product from the plant. The carbon credits associated with the fertilizer product are assumed to remain with the wastewater treatment facility.
- Land application assumes an application rate of 115 kg/ha.
- Mine reclamation assumes an application rate of 100 dry tonnes/ha.

CAPITAL REGIONAL DISTRICT

Core Area Wastewater Treatment Program Biosolids Management Plan

- The carbon sequestration value for mine reclamation is based on a case study of the Highland Valley Copper Mine Rehabilitation. This value is higher than the value for carbon sequestration on agricultural land.
- The hybrid poplar site process emissions (weeding, tilling, and thinning) are equivalent to the carbon sequestration offsets.
- Energy produced from biomass is a net energy value that includes electrical and heat energy captured from co-burning.
- Energy production from woody biomass for the hybrid poplar alternative is used to offset coal.
- Topsoil blending uses best management practices (C:N>30:1 and maintenance of aerobic conditions), causing the emissions due to storage to be negligible.
- Topsoil blending emissions were calculated based on operating procedure used at TAGRO in Tacoma, Washington.

Energy Production Alternatives

- The carbon footprint analysis does not include credits or debits associated with the inclusion of MSW in the energy production alternatives. For example, landfill emissions, energy production, and other life-cycle analysis components associated with MSW are not included in the analysis. This is because the analysis is focused on evaluating the best management alternatives for biosolids and not for MSW.
- The fluidized bed combustion (FBC) facility is located at the WWTP site.
- The mass burn facility is located at Hartland landfill.
- The mass burn grate fire scenario is based on the emissions factors from the life-cycle assessment for Durham York (Whitford 2009).
- Fly and bottom ash do not contribute to landfill fugitive emissions.
- Nitrous oxide emissions are considered negligible for FBC and mass burn because burn temperatures are assumed to be greater than 900°C.

8.4 GREENHOUSE GAS CREDITS

Biosolids management alternatives can provide renewable sources of energy and nutrients that can serve to offset equivalent GHG emissions associated with nonrenewable sources of energy and nutrients. A brief overview of the GHG credits incorporated in this analysis related to biosolids management alternatives is provided in this section.

Table 8.2 summarizes the emissions factors associated with the offsets described in this section. The emissions factors associated with the offsets are based on professional judgment of the best available data and research at this time, including BEAM (CCME 2009). As additional data and research become available, emissions factors associated with offsets may be modified in the future.

For the purposes of this carbon footprint analysis, GHG credits refer to the amount of anthropogenic GHGs avoided by utilizing alternative renewable resources. For example, dried biosolids are used in lieu of natural gas or other fossil fuels in combustion processes. Because the burning of natural gas releases anthropogenic GHG, the amount of natural gas replaced by biosolids is considered a credit for the purposes of this analysis. The key carbon credits (or GHG offsets) associated with the alternatives analyzed are described further below.

- **Fertilizer and soil amendment credits:** Biosolids topsoil products are other resources that provide sources of GHG offsets. These products can be land-applied in place of chemical fertilizers, offsetting the industrial production of nitrogen and phosphorous. Biosolids also provide an additional benefit by sequestering carbon in “disturbed” soils by adding organic matter, which increases the soil carbon and the soil storage capacity.
- **Energy production credits:** A dried biosolids fuel product as well as wood chips (derived from trees grown where biosolids are applied) can be used in lieu of burning of coal as a heat/energy source in cement manufacturing, pulp mills, or WTE facilities. Although the nutrient value of the biosolids is lost during this practice, the use of fossil fuels in these processes is reduced, resulting in a carbon offset.
- **Process credits:** All of the alternatives (with the exception of the WTE raw sludge alternatives) include digestion of biosolids and purification of the digester gas for use as a fuel to offset natural gas, resulting in a net GHG offset for the biosolids treatment processes.

8.5 CARBON FOOTPRINT RESULTS

The estimated annual carbon footprint in tonnes of CO₂ associated with each biosolids management option is summarized in **Table 8.2**. This analysis is based on initial design assumptions for each alternative described earlier in this report. Further refinement of this analysis will be conducted in the future as the alternatives analysis and design process proceeds.

A negative value indicates that there is a net GHG offset (credit) associated with the alternative. A positive value indicates there is a net increase in GHG emissions associated with this alternative.

CAPITAL REGIONAL DISTRICT

Core Area Wastewater Treatment Program
 Biosolids Management Plan

Table 8.2 – Estimated Carbon Footprint by Biosolids Management Option

Management Alternative	Debits	Credits	Total
	Tonne CO ₂ /yr		
Land utilization			
Land application	1,574	-9,944	-8,370
Mine reclamation	1,602	-13,727	-12,125
Biosolids for fuel			
Cement kiln	7,042	-16,366	-9,324
WTE: fluidized bed with raw sludge	2,096	-625	1,470
WTE: fluidized bed with digested biosolids	8,062	-8,197	-135
WTE: mass burn co-combustion of MSW and raw sludge ¹	5,385	-320	5,065
WTE: mass burn co-combustion of MSW and digested biosolids ¹	2,855	-7830	-4,948
Soil amendment			
Topsoil blend	1,513	-10,093	-8,580
Compost (best management practices)	1,523	-10,093	-8,571
Thermally dried product	2657	-10,093	-7427
Biomass production (hybrid poplar)	1,384	-9,520	-8,136
Landfill of wet cake biosolids with biogas purification on site	9,870	-8,598	1,272

Note:

1. The WTE mass burn co-combustion alternatives do not include credits or debits associated with the inclusion of MSW.

The biosolids end-use alternatives with a net negative carbon footprint include, from highest to lowest:

- mine reclamation
- biomass production (hybrid poplar)
- cement kiln
- thermally dried soil amendment product
- topsoil blend soil amendment
- land application
- compost (best management practices)
- WTE mass burn co-combustion
- WTE FBC with digested biosolids.

The alternatives with a net positive carbon footprint are landfill, WTE FBC with raw sludge, and WTE mass burn with raw sludge.

8.6 REFERENCES

- Abu-Orf, M., Reade, J., Mulamula, L., Pound, C., Sobeck Jr., R.G., Locke, E., Peot, C., Murthy, S., Kharkar, S., Bailey, W., Benson, L., Sultan, M., Carr, J., Derminassian, G., Shih, Y. 2008. Carbon Footprinting for Biosolids Processing and Management Alternatives at DCWASA's Blue Plains AWTP. Proceedings of the Water Environment Federation. Sustainability Conference.
- BC Hydro.2004. BC Hydro Greenhouse Gas Report.
http://www.bchydro.com/etc/medialib/internet/documents/environment/pdf/environment_2004_ghg_report.Par.0001.File.environment_2004_ghg_report.pdf
- Beecher, N. 2008. "A Greenhouse Gas Emissions Analysis of Biosolids Management Options for Merrimack, NH". Northeast Biosolids Residual Association.
- Brown S., Kruger C., Subler S. 2008. Greenhouse Gas Balance for Composting Operations. J. Environmental Quality (37):1396–1410.
- Brown S. and Leonard P.2004. Biosolids and Global Warming Evaluating the Management impacts. Biocycle magazine.
- CCME, 2009: The Biosolids Emissions Assessment Model (BEAM): A Method for Determining Greenhouse Gas Emissions from Canadian Biosolids Management Practices Final Report.
- CRD. 2008. Discussion Paper-Biosolids Management/Organic Residuals Energy and Resource Recovery (031-DP-3). Capital Regional District Core Area Wastewater Management Program. <http://www.wastewatremadeclear.ca/media/archived-documents/>
- de Haas, D., Foley, J., and Barr, K., 2008. Greenhouse Gas Inventories From WWTPs – The Trade-off with Nutrient Removal. Proceedings of the Water Environment Federation. Sustainability Conference.
- Dyer J.A. and Desjardins R.L. 2006.Carbon Dioxide Emissions Associated with the Manufacturing of Tractors and Farm Machinery in Canada. Biosystems Engineering 93(1):107–118.
- Energy Information Administration (EIA). Voluntary Reporting of Greenhouse Gas Program Fuel and Energy Source Codes and Emission Coefficients. Official Energy Statistics from the U.S. Government.
- EPA, 2003. Direct Emissions from Iron and Steel Production. Climate Leaders U.S. Environmental Protection Agency.
- Flower D.J.M., and Sanjayan, J.G. 2007. Greenhouse Gas Emissions due to Concrete Manufacture. International Journal of Life Cycle Assessment. Vol: 12, No.5.

CAPITAL REGIONAL DISTRICT

Core Area Wastewater Treatment Program
Biosolids Management Plan

- GVRD, 2003. Nutrifor Program Annual Report 2003. Greater Vancouver Regional District.
- Intergovernment Panel on Climate Change. 2006. IPCC Guidelines for National Greenhouse Gas Inventories. <http://www.ipcc-nggip.iges.or.jp/public/2006gl/index.html>
- Kruse et al. 2007. A modal comparison of domestic freight transportation effects on the general public. USDOT Maritime Administration and National Waterways Foundation. http://www.americanwaterways.com/press_room/news_releases/NWFStudy.pdf
- Larsson S and Lindegaard K. 2003. Full Scale Implementation of short rotation willow coppice SRC, in Sweden. Agrobransle http://www.shortrotationcrops.org/PDFs/IEA_Larsson&Lindegaard.pdf
- Lee J; Cho H; Choi B; Sung J; Lee S; Shin M (2000). Life cycle analysis of tractors. International Journal of Life Cycle Analysis, 5(4), 205–208.
- Lou and Nair (2009). The impact of landfilling and composting on greenhouse gas emissions-A review. Bioresource Technology 100: 3792–3798
- Murray A., Horvath A., Nelson K.L. 2008. Hybrid Life-Cycle Environmental and Cost Inventory of Sewage Sludge Treatment and End-Use Scenarios: A Case Study from China. Environmental Science & Technology. 42: 3163–3169.
- Recycled Organics Unit. 2006. Life cycle inventory and life cycle assessment for windrow composting systems. The Univ. of New South Wales, Sydney, Australia. Available at <http://www.recycledorganics.com/publications/reports/lca/lca.htm>
- Stantec, 2006. CEA Showcase Awards Submission: Sustainable Landfill Bio-Cell. City of Calgary Waste & Recycling Services.
- Suzuki Y., Ochi, S., Kawashima Y., Hiraide, R. 2003. Determination of Emissions Factors of Nitrous Oxide from Fluidized Bed Sewage Sludge Incinerators by Long-term Continuous Monitoring. Journal of Chemical Engineering of Japan. Vol. 36. No.4: 458–463.
- Vande Walle, I., Van Camp, N., Van de Castele, L., Verheyen, K., Lemeur, R. 2007. Short-rotation forestry of birch, maple, poplar and willow in Flanders (Belgium) 11.
- WEF, 1995. “Biosolids Composting, a special publication” Water Environment Federation.
- Whitford J, 2009. “Facility Energy and Life Cycle Assessment-Technical Study Report.” Durham York Residual Waste EA Study. GENIVAR.
- Wiles, CC. 1996. Municipal solid waste combustion ash: State-of-the-knowledge. Journal of Hazardous Materials Vol. 47. Iss.1–3: 325–344

Section 9 Economic Evaluation

This section presents the economic evaluation of the biosolids treatment facility and utilization/disposal alternatives. The selected alternatives are organized into capital costs, operating costs, and revenues. A net present value (NPV) analysis is included at the end of the section. Selection and refinement of a final solids management alternative will be conducted during the predesign, and any modifications/refinements to the facility design will impact the final costs and potentially the economic analysis.

9.1 BASIS OF COST ESTIMATE

To enable completion of TBL assessments and to obtain an initial indication of capital costs for each alternative, comparative cost estimates were prepared. It is noted that these costs are at a preliminary stage. The bases of the estimates follow a similar format as completed in previous CRD studies for the Core Area Wastewater Treatment Program with respect to direct and indirect costs to provide a basis of comparison of costs. The cost estimates are presented for the alternatives and options described in the following sub-sections.

9.1.1 Biosolids Treatment Facility Alternatives

Separate cost estimates were developed for the different biosolids treatment facility alternatives listed below:

- **Co-digestion with co-digestion substrate, source separated food waste, or other food production waste products:** The biosolids treatment facilities are assumed to be located adjacent to the liquid stream facilities at the West Shore site and at a separate Inner Harbour site serving the McLoughlin Point liquid treatment facilities. These are the sites represented by the currently favoured Option 1A. Facilities include digestion, dewatering, drying, odour control, and gas treatment.
- **Waste-to-energy (WTE) facility with biosolids and solid waste:** The following four WTE alternatives were evaluated:
 - Raw dewatered solids incinerated at the biosolids treatment facility with steam production to generate power
 - Digested biosolids incinerated at the biosolids treatment facility in an FBI with steam production to generate power
 - Raw dewatered solids transported to a WTE facility located at the Hartland landfill and incinerated with solid waste in a mass burn facility with steam production to generate power

CAPITAL REGIONAL DISTRICT

Core Area Wastewater Treatment Program Biosolids Management Plan

- Digested biosolids transported to a WTE facility located at the Hartland landfill and incinerated with solid waste in a mass burn facility with steam production to generate power.

9.1.2 Biosolids Utilization Options

There are numerous options for biosolids product utilization including cement kiln fuel, topsoil manufacturing, biomass (e.g., willow coppice) production, and land reclamation. Each utilization option includes capital and operating expenditures. The biosolids utilization options developed in this evaluation include the following:

- Composting of dried digested biosolids to produce a salable soil amendment product
- Thermally dried digested biosolids used for a manufactured topsoil product
- Thermally dried digested biosolids for sale as fuel to cement kiln, pulp mill, or private WTE facility
- Thermally dried digested biosolids used as a soil amendment product for land application or mine (land) reclamation.

9.1.3 Direct Costs

The direct costs assumed for this evaluation follow a similar format as completed in previous CRD studies for the Core Area Wastewater Treatment Program, as follows:

- Capital construction costs
- Design contingency at 10% of construction costs
- Construction contingency costs at 15% of construction costs.

9.1.4 Indirect Costs

The direct costs assumed for this evaluation follow a similar format as completed in previous CRD studies for the Core Area Wastewater Treatment Program, as follows:

- Engineering at 15% of direct costs
- Administration at 3% of direct costs
- Miscellaneous at 2% of direct costs.

9.1.5 Financing Costs

The following financing costs are assumed for this evaluation follow a similar format as completed in previous CRD studies for the Core Area Wastewater Treatment Program, as follows:

- Interim financing at 4% of direct and indirect costs
- Inflation to midpoint of construction: 2% per annum to 2014.

CAPITAL REGIONAL DISTRICT

Core Area Wastewater Treatment Program
Biosolids Management Plan

It is noted that capital costs could vary depending on market conditions at time of tender, the overall procurement strategy, and the risk profile of a particular project.

9.2 CAPITAL COSTS

To arrive at preliminary capital costs, representative technologies described in Section 5 were selected. Detailed design data and a generic site layout were prepared for the biosolids treatment facilities and are presented in Section 7. Detailed cost estimates were then prepared for these facilities. All capital costs are inflated to the midpoint of construction, year 2014.

Capital costs for the WTE mass burn facilities were estimated and then checked against six project estimates found during a literature review (see Section 9.6) Median capital costs are approximately \$775/annual design tonne with a standard deviation of around 50%. The median operating costs/tonne are approximately \$65 with a standard deviation of over 30%. **Table 9.1** summarizes the costing component of mass burn facilities.

Table 9.1 – WTE Mass Burn Facility Cost Criteria Summary

Parameter	Criteria
Median capital cost	\$775/annual design tonne +/- 50%
Median operating cost	\$65/tonne +/- 30%
Feedstock	<ul style="list-style-type: none">– MSW, biomass– Minimal waste preparation/pre-processing required by technology– Designed to process variable waste streams
Residual to disposal	<ul style="list-style-type: none">– 5% (by weight) if bottom ash can be marketed for other applications– Up to 20 to 25% by weight if it is not (0.2 to 0.25 tonnes per input tonne)– Landfill capacity consumption reduced by up to 93%
Potential revenue streams	<ul style="list-style-type: none">– Electricity, heat (steam and/or hot water), recyclable metals, construction aggregate– Electricity production, 0.5 to 0.6 MWh/annual tonne of MSW for older facilities– Electricity production rates of between 0.75 to 0.85 MWh/annual tonne for newer facilities
Scalability	Various sizes of modular units

Source: Juniper, 2007 a) and b), *Large Scale EFW Systems for Processing MSW; Small to Medium Scale Systems for Processing MSW*.

9.2.1 Biosolids Treatment Facility Capital Costs

The estimated capital costs for the biosolids treatment facilities are presented in **Table 9.2**. The total capital costs of both facilities (Upper Victoria Harbour and West Shore) are summarized for each alternative. The costs presented in the table are based on stated assumptions using the best information available at this time and are subject to change as the program develops.

As previously described, the basic anaerobic digestion system for the Upper Victoria Harbour site includes four digesters. The digestion system is designed to accommodate peak 14-day loads with one digester out of service. However, for the WTE alternatives, the Upper Victoria Harbour site includes only three anaerobic digesters, as it is assumed that required redundancy can be supplied by dewatering, drying, and burning raw biosolids during times when a digester has to be off-line for service.

9.2.2 Biosolids Utilization Capital Costs

The estimated capital costs for biosolids utilization are presented in **Table 9.3**. These costs include handling equipment and other facilities required outside the treatment plant fence line for product preparation, transport, and final utilization.

9.3 OPERATIONS AND MAINTENANCE (O&M) COSTS

9.3.1 Biosolids Treatment Facility O&M Costs

The estimated O&M costs for the biosolids treatment facility are presented in **Table 9.4**.

CAPITAL REGIONAL DISTRICT

Core Area Wastewater Treatment Program
Biosolids Management Plan

Table 9.2 – Biosolids Treatment Facility Capital Costs¹

	Co-digestion	WTE			
		Raw Sludge at WWTP Site	Digested Sludge at WWTP Site	Raw Sludge with MSW at Hartland	Digested Sludge with MSW at Hartland
Civil/site work	\$9,800,000	\$9,800,000	\$9,800,000	\$9,800,000	\$9,800,000
Yard piping	\$7,500,000	\$7,500,000	\$7,500,000	\$7,500,000	\$7,500,000
Anaerobic digestion	\$33,000,000		\$28,600,000		\$28,600,000
Dewatering	\$23,500,000	\$39,900,000	\$23,500,000	\$39,900,000	\$23,500,000
Dryers	\$19,900,000	\$39,800,000	\$19,900,000	\$39,800,000	\$19,900,000
Odour control	\$600,000	\$600,000	\$600,000	\$600,000	\$600,000
Energy building/heat extraction and recovery	\$4,400,000		\$4,400,000		\$4,400,000
Gas scrubbing	\$8,200,000		\$8,200,000		\$8,200,000
Gas flares	\$1,300,000		\$1,300,000		\$1,300,000
Bio-filter	\$6,700,000	\$10,100,000	\$6,700,000	\$10,100,000	\$6,700,000
Sludge screening	\$3,300,000		\$3,300,000		\$3,300,000
Electrical and instrumentation	\$17,800,000	\$15,100,000	\$17,200,000	\$15,100,000	\$17,800,000
Co-digestion substrate receiving/sludge blend tanks	\$9,200,000		\$9,200,000		\$9,200,000
Direct Construction Costs					
Construction costs	\$145,100,000	\$122,800,000	\$140,200,000	\$122,800,000	\$140,800,000
Design contingency (10% of construction costs)	\$14,500,000	\$12,300,000	\$14,000,000	\$12,300,000	\$14,100,000
Construction contingency (15% of construction costs)	\$21,800,000	\$18,400,000	\$21,000,000	\$18,400,000	\$21,100,000
Total Direct Costs	\$181,400,000	\$153,500,000	\$175,200,000	\$153,500,000	\$176,000,000
Indirect Costs					
Engineering (15% of direct costs)	\$27,300,000	\$23,100,000	\$26,300,000	\$23,100,000	\$26,400,000
Administration (3% of direct costs)	\$5,500,000	\$4,600,000	\$5,300,000	\$4,600,000	\$5,300,000
Miscellaneous (2% of direct costs)	\$3,600,000	\$3,100,000	\$3,500,000	\$3,100,000	\$3,500,000
Total Indirect Costs	\$36,400,000	\$30,800,000	\$35,100,000	\$30,800,000	\$35,200,000

CAPITAL REGIONAL DISTRICT

Core Area Wastewater Treatment Program
Biosolids Management Plan

Table 9.2 – Biosolids Treatment Facility Capital Costs¹

	Co-digestion	WTE			
		Raw Sludge at WWTP Site	Digested Sludge at WWTP Site	Raw Sludge with MSW at Hartland	Digested Sludge with MSW at Hartland
Subtotal (Direct and Indirect Costs)	\$217,800,000	\$184,300,000	\$210,300,000	\$184,300,000	\$211,200,000
Interim financing (4% of subtotal)	\$8,700,000	\$7,300,000	\$8,400,000	\$7,300,000	\$8,400,000
Inflation to midpoint of construction: Year 2014 (2% per annum)	\$28,400,000	\$23,900,000	\$27,400,000	\$23,900,000	\$27,500,000
Total Capital Costs	\$254,900,000	\$215,500,000	\$246,100,000	\$215,500,000	\$247,100,000
WTE Facility Capital Costs²					
WTE facility total capital costs including MSW				\$198,900,000	\$195,400,000
WTE costs for biosolids only		\$54,600,000 ^{3,6}	\$46,900,000 ^{4,6}	\$36,808,000 ^{5,7}	\$18,300,000 ^{5,7}
Total Capital Costs Including MSW	\$254,900,000	\$270,100,000	\$293,000,000	\$414,400,000	\$442,500,000
Total Capital Costs for Biosolids Only	\$254,900,000	\$270,100,000	\$293,000,000	\$252,300,000	\$265,400,000

Notes:

1. The capital costs of the facility heat pumps are not included in this section. The capital costs are included in the liquids treatment facility section and are equal for all options.
2. Costs for WTE facilities are installed costs. The WTE facilities includes incinerator, energy recovery system, emissions treatment equipment, etc.
3. The FBI is sized for dried raw sludge at peak day loads.
4. The FBI is sized for dried digested sludge at peak day loads.
5. The mass burn facility is sized for a capacity of 210,000 tonnes/year. The biosolids portion of the mass burn facility was determined for peak 14-day solids load and 50% cake. The cost of the WTE facility is displayed as a fraction of the total costs based on the ratio of biosolids to MSW. An additional 25% capital costs was added to account for dried biosolids handling, feeding, and monitoring equipment at the WTE facility.
6. WTE facility at the WWTP site includes markup of installed capital costs for administration, miscellaneous, interim financing, and 10% for building costs (total markup 19%).
7. WTE facility at Hartland includes markup of installed capital cost for administration and interim financing (total markup 7%).

CAPITAL REGIONAL DISTRICT

Core Area Wastewater Treatment Program
Biosolids Management Plan

Table 9.3 – Biosolids Utilization Capital Costs

	Compost Product	Top Soil Blend	Thermally-Dried Product ¹	Dried Fuel Product ²	Biomass Production ⁴	Land Application ³	Mine Reclamation ³
Direct Construction Costs							
Construction costs	\$4,560,000	\$2,775,000	\$0	\$0	\$5,345,000	\$345,000	\$345,000
Design contingency (10% of construction costs)	\$456,000	\$278,000	\$0	\$0	\$534,500	\$35,000	\$35,000
Construction contingency (15% of construction costs)	\$684,000	\$416,000	\$0	\$0	\$801,800	\$0	\$0
Total Direct Costs	\$5,700,000	\$3,469,000	\$0	\$0	\$6,681,300	\$380,000	\$380,000
Indirect Costs							
Engineering (15% of direct costs)	\$855,000	\$520,000	\$0	\$0	\$0	\$0	\$0
Administration (3% of direct costs)	\$171,000	\$104,000	\$0	\$0	\$0	\$0	\$0
Miscellaneous (2% of direct costs)	\$114,000	\$69,000	\$0	\$0	\$0	\$0	\$0
Total Indirect Costs	\$1,140,000	\$694,000	\$0	\$0	\$0	\$0	\$0
Subtotal (Direct + Indirect Costs)	\$6,840,000	\$4,163,000	\$0	\$0	\$6,681,300	\$380,000	\$380,000
Interim financing (4% of subtotal)	\$274,000	\$167,000	\$0	\$0	\$267,300	\$15,000	\$15,000
Inflation to midpoint of construction: 2014 (2% per annum)	\$889,000	\$541,000	\$0	\$0	\$868,600	\$49,000	\$49,000
Total Capital Costs	\$8,003,000	\$4,870,000	\$0	\$0	\$7,817,000	\$444,000	\$444,000

Notes:

1. All equipment for storage and dispensing of thermally dried product is available at the plant; therefore no capital costs are associated with this option.
2. All equipment for storage and dispensing of thermally dried biosolids fuel is the plant; therefore no capital costs are associated with this option.
3. Construction costs include equipment only: tractor, spreader, and front-end loader costs. A 10% contingency on the equipment cost is assumed. No land costs are included as it is assumed biosolids are applied to private land.
4. Construction costs include equipment for biosolids application: tractor, spreader, and front-end loader. A 10% contingency is included on equipment costs. Land requirements for biomass production are 500 ha at approximately \$10,000/ha; land costs are included with the construction costs.

CAPITAL REGIONAL DISTRICT

Core Area Wastewater Treatment Program

Biosolids Management Plan

Table 9.4 – Biosolids Treatment Facility O&M Costs

	Co-digestion	WTE			
		Raw Sludge at the WWTP Site ^{11, 12}	Digested Sludge at the WWTP Site ^{11, 12}	Raw Sludge with MSW at Hartland	Digested Sludge with MSW at Hartland
Operating Costs for Biosolids Treatment					
Power costs ^{1, 11}	\$2,100,000	\$900,000	\$1,600,000	\$1,700,000	\$2,100,000
Chemical costs ²	\$700,000	\$1,500,000	\$700,000	\$1,500,000	\$700,000
Water costs ³	\$100,000	\$70,000	\$100,000	\$70,000	\$100,000
Operating Labour for Biosolids Treatment					
Chief operator ⁵	2	2	2	2	2
Operator ⁶	4	2	4	2	4
Labourer ⁷	3	2	3	2	3
Total operating labour costs for biosolids treatment	\$670,000	\$460,000	\$670,000	\$460,000	\$670,000
Maintenance costs for biosolids treatment ⁸	\$2,800,000	\$2,400,000	\$2,700,000	\$2,400,000	\$2,700,000
WTE					
Operating costs for WTE ^{9, 10}	-	\$1,000,000	\$400,000	\$600,000	\$300,000
Operating labour for WTE					
Chief operator ⁵	-	0	0	0	0
Operator ⁶	-	4	3	3	2
Labourer ⁷	-	3	2	2	2
Total Operating Labour for WTE	-	\$500,000	\$300,000	\$300,000	\$300,000
Maintenance costs for WTE ⁸	-	\$600,000	\$500,000	\$400,000	\$200,000
Total Costs					
Total operating costs (biosolids and WTE)	\$3,700,000	\$4,400,000	\$3,900,000	\$4,700,000	\$4,200,000
Total maintenance costs (biosolids and WTE)	\$2,800,000	\$3,000,000	\$3,200,000	\$2,800,000	\$2,900,000
Total O&M Costs	\$6,500,000	\$7,400,000	\$7,100,000	\$7,500,000	\$7,100,000

Notes:

1. Power costs assume a unit cost of \$0.08/kWh.
2. Chemical costs consist of polymer for dewatering at \$4.50/kg polymer.
3. Water costs assume a unit cost of \$700/ML.
4. Costs were scaled linearly from a Calgary FBI operating costs, \$3.1M operating costs for a 55-DT facility in 2000.
5. Chief operator assumed to cost \$100,000/year.
6. Operator assumed to cost \$80,000/year.
7. Labourer assumed to cost \$50,000/year.
8. Maintenance costs estimated at 1.1% of capital costs.
9. Operating costs for the FBI at the WWTP site assumes an operating cost of \$0.146/kWh, which includes cost of chemicals, water, power, consumables, equipment repair, administration, insurance, etc. Operating costs information is provided by U.S. EPA Biomass CHP Partnership, Biomass CHP Catalog of Technologies 2007.
10. Operating cost of mass burn facility assumes a unit cost of \$85/dry tonne less the labour costs. This value includes consumables, equipment repair/refurbishment, auxiliary fuel, utilities, power, administration, insurance, and taxes.
11. Waste heat from the FBI will be used by the dryer thus reducing power costs for heat pumps.
12. Ash generation rate from FBI is approximately 28% of input dry solids. Disposal options for ash include landfilling or beneficial reuse, and costs for ash disposal are not included in this analysis.

CAPITAL REGIONAL DISTRICT

Core Area Wastewater Treatment Program
Biosolids Management Plan

9.3.2 Biosolids Utilization Operations and Maintenance Costs

The estimated capital costs for biosolids utilization are presented below in **Table 9.5**.

Table 9.5 –Biosolids Utilization Operating and Maintenance Costs

	Compost Products	Topsoil Blending	Thermally Dried Product	Dried Fuel Product	Biomass Production	Land Application	Mine Reclamation
Material costs	\$328,000 ¹	\$229,000 ²	-	-	\$100,000 ¹²	-	-
Operating labour costs							
Operators	4	3	1	1	3	1	1
Total operating labour ³	\$240,000	\$180,000	\$60,000	\$60,000	\$180,000	\$60,000	\$60,000
Maintenance costs ⁴	\$228,000	\$139,000	\$0	\$0	\$267,300	\$17,000	\$17,000
Operating costs	\$92,000 ⁵	\$25,000 ⁶	\$30,000 ⁷	\$30,000 ¹⁴	\$150,000 ¹³	\$184,000 ⁸	\$184,000 ⁸
Hauling costs	\$60,000 ⁹	\$60,000 ⁹	\$0	\$0 ¹⁰	\$123,000 ¹⁰	\$123,000 ¹⁰	\$123,000 ¹⁰
Total Operating Costs	\$948,000	\$632,000	\$90,000	\$90,000	\$820,000	\$383,000¹¹	\$383,000¹¹

Notes:

1. Material costs for sawdust: 20,400 m³/year at a sawdust cost of \$16.10/m³. Additional bulking agent from diverted yard waste can be used to offset sawdust requirements. The mixture is 2:1 sawdust to biosolids.
2. Material costs for 10,200 m³/year of sawdust at \$16.10/m³ and 5,100 m³/year of sand at \$12.60/m³. The mixture is 2:2:1 sawdust to biosolids to sand.
3. Operator cost assumed to be \$60,000/year.
4. Estimated at 5% of capital costs.
5. Operation cost of facility includes cost for aeration blower (150 hp at \$0.08/kWh).
6. Operation costs assumed \$4.14/DT for blending of topsoil product. Costs derived from Tacoma WWTP TAGRO operation.
7. Thermally dried product is sold directly to manufacturers. Storage and loading building operating costs for equipment and power assumed at \$30,000/year.
8. Land application costs assume \$30/wet tonne. Cost includes labour, equipment, and fuel costs. Land application can be conducted by the CRD or contracted.
9. Hauling costs based on transfer of 225 loads of biosolids per year at 34km (round trip), 2hrs per load, \$125/hr cost of vehicle, 2.13km/L fuel efficiency and \$0.95/L diesel costs.
10. Hauling costs based on transfer of 225 loads of biosolids per year at 100km (round trip), 4hrs per load, \$125/hr cost of vehicle, 2.13km/L fuel efficiency and \$0.95/L diesel costs.
11. When solids throughput exceeds dryer capacities, some land application of dewatered cake will occur and costs will be different.
12. Material costs are estimated as 2% of the land purchase cost.
13. Operating costs are assumed to be \$300/ha. The biomass production site is 500 ha.
14. Dried biosolids product is sold directly to the manufacturers. Storage and loading building operating costs for equipment and power are assumed at \$30,000/year.

9.4 POTENTIAL REVENUES

Resources recovered from solids processing could include biogas, a soil amendment product, a dried fuel product, or power from a WTE facility.

Biogas produced from digestion would be scrubbed to natural gas quality and sold to the local natural gas utility.

A soil amendment product would have a variety of potential beneficial uses, including use as a fertilizer for locations on Vancouver Island, a blended topsoil fertilizer product or compost product for sale to the local communities, and use as a mine reclamation material. Dried biosolids can be sold as a fuel to industries burning solid fuel, such as cement kilns, paper mills, and energy facilities. Likewise, raw or digested sludge can be used to produce heat and power in a WTE facility.

Table 9.6 presents the potential revenues for the biosolids treatment facility. For the purposes of this summary, each revenue stream presented in the table assumes 100% of the resources that can potentially generate a revenue stream are dedicated to that option. Revenues were not provided for land application alternatives as these biosolids utilization options are primarily used to provide beneficial use with avoided disposal costs. These options typically do not generate revenue.

It should be noted that these are potential gross revenues and do not include costs for transport, utilization, or handling of the products.

Table 9.6 – Biosolids Treatment Facility Potential Revenues

Revenue Stream	Unit	Option 1A Upper Victoria Harbour	Option 1A West Shore	Total Revenue
Biomethane Recovery				
Digester gas production ¹	m ³ /day	16,900	4,100	21,000
Average biomethane produced ²	N m ³ /hr	320	80	400
Unit biomethane value ³	\$/GJ	\$8.00	\$8.00	\$8.00
Potential revenue	\$/yr	\$874,000	\$218,000	\$1,092,000
Dried Fuel Product				
Digested biosolids produced	kg/day	13,400	3,300	16,700
Unit dry biosolids value ^{4,5}	\$/GJ	\$1.60	\$1.60	\$1.60
Potential revenue	\$/yr	\$141,000	\$35,000	\$176,000
Co-digestion Substrate Tipping Fees				
Average daily co-digestion substrate delivery ⁶	L/day	55,200	13,800	69,000
Tipping rate ⁷	\$/L	\$0.07	\$0.07	\$0.07
Number of trucks ⁸	Trucks/day	8	2	10
Potential revenue ⁹	\$/yr	\$1,410,000	\$353,000	\$1,763,000

CAPITAL REGIONAL DISTRICT

Core Area Wastewater Treatment Program

Biosolids Management Plan

Table 9.6 – Biosolids Treatment Facility Potential Revenues

Revenue Stream	Unit	Option 1A Upper Victoria Harbour	Option 1A West Shore	Total Revenue
Blended Soil Amendment Product				
Digested biosolids produced	kg/day	13,400	3,300	16,700
Digested biosolids produced ¹⁸	m ³ /day	22	6	28
Average blended soil amendment produced ¹⁰	m ³ /day	64	16	80
Average sale price of blended soil amendment ¹¹	\$/m ³	\$10.50	\$10.50	\$10.50
Potential revenue ¹²	\$/yr	\$246,000	\$62,000	\$308,000
Compost				
Digested biosolids produced	kg/day	13,400	3,300	16,700
Digested biosolids produced ¹⁸	m ³ /day	22	6	28
Average compost produced ¹⁶	m ³ /day	67	17	84
Average sale price of compost ¹⁷	\$/m ³	\$10.50	\$10.50	\$10.50
Potential Revenue	\$/yr	\$257,000	\$64,000	\$321,000
Biomass Production				
Willow coppice area	Ha	400	100	500
Usable willow coppice area	Ha	384	96	480
Energy Produced from biomass ²⁰	GJ/ha-yr	61.7	61.7	62
Usable energy produced from hybrid poplar ²¹	GJ/yr	23,700	5,900	29,600
Potential revenue	\$/yr	\$37,908	\$9,477	\$47,386
Thermally Dried Product				
Digested biosolids produced	kg/day	13,400	3,300	16,700
Digested biosolids produced ¹⁸	m ³ /day	22	6	28
Average sale price of product ¹⁹	\$/m ³	\$17.21	\$17.21	\$17.21
Potential revenue	\$/yr	\$140,000	\$35,000	\$175,000
Raw Sludge Power Generation: Onsite Fluidized Bed Incinerator				
Raw biosolids	kg/day	24,700	6,000	30,700
Power produced ¹⁴	MWh/day	14	4	18
Revenue ²²	\$/yr	\$411,000	\$103,000	\$514,000
Digested Sludge Power Generation: Onsite Fluidized Bed Incinerator				
Digested biosolids	kg/day	13,400	3,300	16,700
Power produced ¹⁴	MWh/day	6	1	7
Revenue ²²	\$/yr	\$164,000	\$41,000	\$205,000
Raw Sludge Power Generation: Offsite Mass Burn Incinerator				
Raw biosolids	kg/day	24,700	6,000	30,700
Power produced ¹²	MWh/day	32	8	40
Revenue ¹³	\$/yr	\$762,000	\$185,000	\$947,000

Table 9.6 – Biosolids Treatment Facility Potential Revenues

Revenue Stream	Unit	Option 1A Upper Victoria Harbour	Option 1A West Shore	Total Revenue
Digested Sludge Power Generation: Offsite Mass Burn Incinerator				
Digested biosolids	kg/day	13,400	3,300	16,700
Power produced ¹⁵	MWh/day	14	4	18
Revenue ¹³	\$/yr	\$339,000	\$83,000	\$442,000

Notes:

- Annual average gas production with co-digestion substrate addition, 30% by VS load.
- Biomethane produced assumes 92.5% recovery of biogas CH₄ and 95% equipment availability to produce a final gas product of 98% CH₄ and 2% CO₂. Normalized at 0°C and 1 atm. Biomethane recovery rate presented in Table 9.6 represents the biogas generated with four digesters in operation at the Upper Victoria Harbour site. For the WTE alternatives, only three digesters will be installed, and under this condition biomethane recovery will decrease by approximately 5%.
- Terasen has expressed interest in a long-term contract for biomethane at \$6 to \$10 per GJ. An average of \$8 per GJ is assumed here, but the revenue may be higher or lower based on final contract negotiations with Terasen. Higher heating value for 98% methane by volume is 38,971 kJ/Nm³.
- Price of biosolids fuel/wood fuel is based on 80% of average cost of equivalent coal energy (\$2.00/GJ). Price for coal energy is based on \$53.09/tonne and 26.7 MJ/kg (U.S. DOE).
- Higher heating value of dried biosolids, 18,000 kJ/kg.
- Excess capacity in digester is assumed to be used to accept FOG, assuming approximately 80% capture of FOG available in CRD.
- Tipping fee is assumed equal to septage receiving tipping fee at Metro Vancouver's Iona Island WWTP.
- Co-digestion substrate truck volume assumed is 10 m³ and truck number calculated assuming trucks deliver co-digestion substrate at 3/4 of capacity (7.5 m³/truck).
- Revenue for accepting co-digestion substrate assumes receiving substrate 365 days per year.
- Blended soil amendment product consists of 2:2:1 dried biosolids, sawdust, and sand, respectively.
- Sale price for blended soil amendment product assumes same blend and price as TAGRO at \$10.50/m³, produced by the Central Treatment Plant, Tacoma, Wash.
- Assumes dry raw sludge HHV of 22,000MJ/tonne and a plant heat rate of 16.9 MJ/kWh, which corresponds to an electrical power rate of 1,300 kWh/tonne
- Assumes power rate of \$0.065/kWh. Values could range from \$0.03/kWh to \$0.12/kWh.
- Based on internal modelling of fluid bed boiler with low pressure steam extraction for sludge drying. The HHV assumed for raw and digested sludge are 22,000 MJ/tonne and 18,000 MJ/tonne. Revenues are based on net power production (parasitic loads subtracted from gross power production).
- Assumes dry digested sludge HHV of 18,000MJ/tonne and a plant heat rate of 16.9 MJ/kWh, which corresponds to an electrical power rate of 1,065 kWh/tonne.
- Assumes compost comprises 2 parts sawdust to 1 part dried biosolids. Additional bulking agent from diverted yard waste can be used to offset sawdust requirements.
- Price of compost is equivalent to price of blended soil amendment product.
- Assumes bulk density of dry biosolids is 600 kg/m³.
- Assumes cost of fertilizer is equivalent to cost of dried product as fuel. In this case, \$17.21/m³ is equivalent to 80% of average cost of equivalent coal energy (\$2.00/GJ). Price for coal energy is based on \$53.09/tonne and 26.7 MJ/kg (U.S. DOE). Biosolids are assumed to have a higher heating value of 18,000 kJ/kg.
- Biomass energy production is based on a biosolids application rate of 12.79 dry tonne/ha, assuming N requirement of 200 kg/ha-yr and 15.6 kg/tonne of N is bioavailable.
- Energy produced from biomass is 61.7 GJ/ha-yr, assuming energy produced from biomass is a net energy value that includes electrical and heat energy captured from burning.
- Assumes power generated will be used onsite to offset power costs. Power cost savings are assumed to be \$0.08/kWh.

9.5 NET PRESENT VALUE ANALYSIS

The capital costs, O&M costs, and revenues were used to develop an NPV analysis of the biosolids treatment facility alternatives and biosolids utilization options. The NPV economic assumptions are presented in **Table 9.7**

Table 9.7 – Net Present Value Analysis Assumptions

Parameter	Assumption
Current year	2015
Baseline year	2065
Population growth rate	0.38%
General inflation	3%
Inflation of natural gas	5%
Inflation of water cost	3%
Inflation of power costs	3%
Operations cost inflation rate	3%
Discount rate	5%

The NPV analysis for each biosolids treatment alternative and each biosolids reuse option are presented in **Table 9.8**. The NPV analysis ranges over 50 years, 2015 to 2065. The biosolids treatment facilities are designed for 2030 design flows and loads, and additional capital costs are required to upgrade the treatment system to meet design flows for 2065. Flows to the West Shore treatment facility will increase by approximately 60% between 2030 and 2065, while the other treatment facilities controlled by the CRD will not have any appreciable increase in flows between 2030 and 2065. It is assumed that only the West Shore treatment facilities will require future capital improvement costs to meet 2065 flows.

The NPV analysis was completed as part of the TBL assessment in Section 11. Assumptions and findings are described further in that section.

CAPITAL REGIONAL DISTRICT

Core Area Wastewater Treatment Program
Biosolids Management Plan

Table 9.8 – Net Present Value Analysis

	Co-Digestion							Waste-to-Energy			
	Compost Products	Topsoil Blending	Dried Fuel Product	Biomass Production	Thermally Dried Product	Land Application	Mine Reclamation	Raw Sludge at WWTP Site	Digested Sludge at WWTP Site	Raw Sludge with MSW at Hartland	Digested Sludge with MSW at Hartland
Capital Costs											
Biosolids treatment facility capital cost	\$254,900,000	\$254,900,000	\$254,900,000	\$254,900,000	\$254,900,000	\$254,900,000	\$254,900,000	\$270,100,000	\$293,000,000	\$252,300,000	\$265,400,000
Offsite capital costs	\$8,003,000	\$4,870,000		\$7,817,000		\$444,000	\$444,000				
Total capital costs	\$262,900,000	\$259,800,000	\$254,900,000	\$262,700,000	\$254,900,000	\$255,300,000	\$255,300,000	\$270,100,000	\$293,000,000	\$252,300,000	\$265,400,000
Present value of capital costs ⁴	\$281,600,000	\$278,400,000	\$273,600,000	\$281,400,000	\$273,600,000	\$274,000,000	\$274,000,000	\$288,900,000	\$313,300,000	\$269,200,000	\$284,100,000
O&M Costs											
Biosolids treatment facility	\$6,453,000	\$6,453,000	\$6,453,000	\$6,453,000	\$6,453,000	\$6,453,000	\$6,453,000	\$7,359,000	\$7,108,000	\$7,445,000	\$7,074,000
Biosolids utilization O&M	\$948,000	\$632,000	\$90,000	\$820,000	\$90,000	\$383,000	\$383,000				
Total O&M life-cycle cost	\$7,400,000	\$7,100,000	\$6,500,000	\$7,300,000	\$6,500,000	\$6,800,000	\$6,800,000	\$7,400,000	\$7,100,000	\$7,400,000	\$7,100,000
Present value of total O&M cost ¹	\$263,300,000	\$252,000,000	\$232,700,000	\$258,700,000	\$232,700,000	\$243,200,000	\$243,200,000	\$261,800,000	\$252,800,000	\$264,800,000	\$251,600,000
Revenue											
Biomethane recovery ¹	\$1,366,000	\$1,366,000	\$1,366,000	\$1,366,000	\$1,366,000	\$1,366,000	\$1,366,000		\$1,297,000		\$1,297,000
Dried biosolids fuel			\$175,550								
Co-digestion tipping fees ²	\$881,000	\$881,000	\$881,000	\$881,000	\$881,000	\$881,000	\$881,000		\$881,000		\$881,000
Blended topsoil product		\$308,000									
Compost product	\$321,000										
Sales from biomass production				\$47,000							
Thermally dried product					\$176,000						
Nutrient recovery: struvite ³											
Power savings								\$514,000	\$205,000	\$947,000	\$422,000
Total revenue generated	\$2,568,000	\$2,555,000	\$2,423,000	\$2,294,000	\$2,423,000	\$2,247,000	\$2,247,000	\$514,000	\$2,383,000	\$947,000	\$2,600,000
Present value of revenue	\$137,600,000	\$137,100,000	\$132,400,000	\$127,900,000	\$132,400,000	\$126,200,000	\$126,200,000	\$18,000,000	\$129,500,000	\$40,900,000	\$140,600,000
Total Net Present Value	\$407,200,000	\$393,400,000	\$373,900,000	\$412,200,000	\$373,900,000	\$391,000,000	\$391,000,000	\$532,700,000	\$436,600,000	\$493,200,000	\$395,100,000

Note:

1. Net present value analysis assumes biomethane energy recovery is \$10/GJ.
2. Net present value selected co-digestion tipping fee of \$0.035/L as a representative tipping fee rate more commonly charged.
3. Revenue from struvite is not included in the net present value. Costs and revenues for nutrient recovery are included with the liquids treatment facilities.
4. To accommodate future expansion of facilities to meet 2065 flows, capital costs equivalent to 60% of the West Shore biosolids treatment facility were included in the net present value analysis; half of these capital costs were assumed to occur in 2030 and the other half in 2048. The FBI facility at the WWTP site is included in the 30% capital cost increase for the West Shore facility. The WTE facility at Hartland is not included in the 30% capital cost increase for West Shore as it is assumed that a mass burn facility will have adequate capacity to receive biosolids in 2065.

9.6 REFERENCES

European Commission, Integrated Prevention and Control. 2006. Reference Document on Best Available Technology for Waste Incineration.

Jacques Whitford, Stantec Limited. 2009. Durham /York Residual Waste Study Environmental Assessment.

MacViro. 2007. City of Ottawa REOI Report.

MacViro. 2007. County of Dufferin RFQ Process.

Section 10 Risk Assessment

10.1 METHODOLOGY

Many communities use risk assessment to identify and quantify the severity of risk associated with the construction and ongoing operation and maintenance of capital projects. Each project or alternative has a unique risk profile. The definition of risk in the context of the Core Area Wastewater Treatment Program is as follows:

An event or situation that has the potential to impact performance, increase scope and/or extend the schedule. The magnitude of the risk is the product of the likelihood or probability of an event times the consequence or impact of the event.

By definition, the impact of underperformance or nonperformance, increased scope, and schedule delays on project implementation is increased costs. The identification and quantification of potential risks at the initial planning phase of a capital project can provide a more complete picture of the implications of selecting and implementing a specific alternative. Quantification of risks can assist decision-makers in the selection of options and identification and mitigation of project-specific risk issues. For the CRD Program, the use of a structured risk assessment process provides an effective technique to highlight the risks that are known at this time. As the project develops and more information becomes available, the risk assessment can be updated and mitigation strategies can be developed for each of the identified risk factors.

For this initial risk assessment, a qualitative evaluation was undertaken using a simple 1-to-3 rating. For probability, the following ratings are used:

- low probability: 1
- medium probability: 2
- high probability: 3.

Similarly for assessing impact, the following ratings are used:

- low impact: 1
- medium impact: 2
- high impact:3.

The product of the probability and the impact provides an overall risk factor. A risk factor of less than 3 is considered a low risk, a risk factor from 3 to 5 is considered a medium risk, and a risk factor greater than 5 is considered a high risk as illustrated in Figure 10.1

Probability	3	3	6	9
	2	2	4	6
	1	1	2	3
		1	2	3
	Impact			
	High risk >5	Medium risk 3 to 5	Low risk <3	

Figure 10.1 – Qualitative Risk Assessment

10.2 RISK MATRIX

A preliminary risk matrix was developed for the biosolids management alternatives. The risk was developed around the following three general categories:

- **Site-Specific Risk:** related to the Upper Victoria Harbour site and the Hartland Landfill site
- **Process-Specific Risk:** for the options with or without anaerobic digestion and with and without incineration
- **End-Use-Specific Risk:** for the various fuel and beneficial land use options.

Within each general category the specific category risk factors were identified and qualitatively assessed based on the 1-to-3 scoring criteria.

The information developed in the risk assessment is incorporated into the Triple Bottom Line (TBL) evaluation. When the risk is equal for all alternatives, the impact on the TBL evaluation is considered neutral; when there is an identified differential risk a risk adjustment factor is

incorporated into the TBL. The specific risk adjustments are described in the TBL Section 11 and in Appendix A.

10.3 RISK RANKING

The preliminary risk scores for the biosolids management alternatives are provided in **Tables 10.2, 10.3, and 10.4**. The information for risk mitigation will be addressed at a later time. The high risks within each of the three general categories are highlighted in red.

10.3.1 Site-Specific Risks

The site-specific risk matrix is presented in Table 10.2.

CAPITAL REGIONAL DISTRICT

Core Area Wastewater Treatment Program
Biosolids Management Plan

Table 10.2 – Site-Specific Risk Matrix

Risk Identification		Risk Assessment			Risk Mitigation
Category	Risk	Probability High = 3 Medium = 2 Low = 1	Impact High = 3 Medium = 2 Low = 1	Risk Factor High >5 Medium 3-4 Low <3	Risk Control Strategies/Actions
Upper Victoria Harbour					
Site	Site purchase	2	3	6	
	Rezoning	2	3	6	
	Permitting	1	2	2	
	Geotechnical	2	2	4	
	Contamination	3	2	6	
	Space adequacy	2	2	4	
	Constructibility	2	2	4	
	Adjacent residents	1	1	1	
	Community				
	Traffic	2	3	6	
	Noise	2	1	2	
	Odour	2	2	4	
	Aesthetics	1	1	1	
	Loss of site access	3	1	3	
	Wildlife	1	1	1	
	Terrestrial	1	1	1	
Loss of property taxes	3	2	6		
Construction	Cost	2	3	6	
	Market conditions	1	3	3	
	Schedule/delays	2	3	6	
	Changes/claims	2	2	4	
Conveyance	PS pipeline performance	2	2	4	
	Truck transportation	1	1	1	
	Barge transportation	1	1	1	
Other	Archeological conditions	1	3	3	
Total				85	

CAPITAL REGIONAL DISTRICT

Core Area Wastewater Treatment Program
Biosolids Management Plan

Table 10.2 – Site-Specific Risk Matrix

Risk Identification		Risk Assessment			Risk Mitigation
Category	Risk	Probability High = 3 Medium = 2 Low = 1	Impact High = 3 Medium = 2 Low = 1	Risk Factor High >5 Medium 3-4 Low <3	Risk Control Strategies/Actions
Hartland Landfill					
Site	Site purchase	1	1	1	
	Rezoning	1	1	1	
	Permitting	1	2	2	
	Geotechnical	2	2	4	
	Contamination	1	2	2	
	Space adequacy	1	1	1	
	Constructability	1	2	2	
	Adjacent residents	1	1	1	
	Community				
	Traffic	1	1	1	
	Noise	1	1	1	
	Odour	2	1	2	
	Aesthetics	1	1	1	
	Loss of site access	1	1	1	
	Wildlife	2	2	4	
	Terrestrial	1	1	1	
Loss of property taxes	1	1	1		
Construction	Cost	1	3	3	
	Market conditions	1	3	3	
	Schedule/delays	1	3	3	
	Changes/claims	2	2	4	
Conveyance	PS pipeline performance	1	1	1	
	Truck transportation	2	1	2	
	Barge transportation	1	1	1	
Other	Archaeological conditions	1	3	3	
Total				46	

CAPITAL REGIONAL DISTRICT

Core Area Wastewater Treatment Program
Biosolids Management Plan

A comparison of the site risks indicated that the Upper Victoria Harbour site (a cumulative risk factor of 85 points) carries more risks than the Hartland site (a cumulative risk factor of 46 points). The key risk factors that contributed to the overall higher risk rating of the Upper Victoria Harbour site are related to the following:

- The Upper Victoria Harbour site is currently privately owned and consequently carries a higher risk for the risk factors of “site purchase” and “loss of property taxes.”
- The Hartland site is currently used as a waste management site eliminating the need for the rezone thus minimizing the “rezone” risk factor .
- The Upper Victoria Harbour site is in a developed urban area and as such carries a higher community “traffic” risk factor.
- The smaller Upper Victoria Harbour site places more constraints on the construction contractors increasing the risk factors of “cost” and schedule delays.

10.3.2 Process-Specific Risks

The process-specific risk matrix is presented in Table 10.3

CAPITAL REGIONAL DISTRICT

Core Area Wastewater Treatment Program
Biosolids Management Plan

Table 10.3 – Process-Specific Risk Matrix

Risk Identification		Risk Assessment			Risk Mitigation
Category	Risk	Probability High = 3; Medium = 2; Low = 1	Impact High = 3; Medium = 2; Low = 1	Risk Factor High >5; Medium 3-4; Low <3	Risk Control Strategies/Actions
Raw Sludge Dewatering and Drying					
Engineering	Foundation/site conditions	1	2	2	
	Process technology	1	2	2	
	Resource recovery	2	2	4	
Financial	Capital cost	2	3	6	
	Operations/maintenance cost	1	2	2	
	Available funding	2	3	6	
	Funding conditions/restrictions	2	2	4	
	Cost escalations	2	3	6	
	Contingency items	2	3	6	
	Financing costs	1	1	1	
	Resource revenues				
	Electrical power	NA	NA		
	Heat	NA	NA		
Methane gas	2	2	4		
Nutrients	1	2	2		
Procurement	Procurement strategy	2	1	2	
Total				47	

CAPITAL REGIONAL DISTRICT

Core Area Wastewater Treatment Program
Biosolids Management Plan

Table 10.3 – Process-Specific Risk Matrix

Risk Identification		Risk Assessment			Risk Mitigation
Category	Risk	Probability High = 3; Medium = 2; Low = 1	Impact High = 3; Medium = 2; Low = 1	Risk Factor High >5; Medium 3-4; Low <3	Risk Control Strategies/Actions
Anaerobic Digestion, Dewatering, and Drying					
Engineering	Foundation/site conditions	2	2	4	
	Process technology	2	2	4	
	Resource recovery	2	2	4	
Financial	Capital cost	2	3	6	
	Operations/maintenance cost	1	2	2	
	Available funding	2	3	6	
	Funding conditions/restrictions	2	2	4	
	Cost escalations	2	3	6	
	Contingency items	2	3	6	
	Financing costs	1	1	1	
	Resource revenues				
	Electrical power	NA	NA		
	Heat	NA	NA		
Methane gas	2	2	4		
Nutrients	1	2	2		
Procurement	Procurement strategy	2	1	2	
Total				51	

CAPITAL REGIONAL DISTRICT

Core Area Wastewater Treatment Program
Biosolids Management Plan

Table 10.3 – Process-Specific Risk Matrix

Risk Identification		Risk Assessment			Risk Mitigation
Category	Risk	Probability High = 3; Medium = 2; Low = 1	Impact High = 3; Medium = 2; Low = 1	Risk Factor High >5; Medium 3-4; Low <3	Risk Control Strategies/Actions
WTE					
Engineering	Foundation/site conditions	2	2	4	
	Process technology	2	3	6	
	Resource recovery	2	2	4	
Financial	Capital cost	2	3	6	
	Operations/maintenance cost	2	2	4	
	Available funding	2	3	6	
	Funding conditions/restrictions	2	2	4	
	Cost escalations	2	3	6	
	Contingency items	2	3	6	
	Financing costs	1	1	1	
	Resource revenues				
	Electrical power	1	2	2	
	Heat	2	2	4	
Methane gas	NA	NA			
Nutrients	NA	NA			
Procurement	Procurement strategy			0	
Total				53	

CAPITAL REGIONAL DISTRICT

Core Area Wastewater Treatment Program
Biosolids Management Plan

A comparison of the process risks indicates that the WTE incineration and related thermal-driven energy generation process (with a cumulative risk factor of 53 points) carries more risk than either of the dewatering and drying of raw (with a cumulative risk score of 47 points) or digested biosolids process trains (with a cumulative risk score of 49 points). The key risk factors that drove these differences are the complexity of the incineration/thermal power generation system as compared to anaerobic digestion/centrifuge dewatering/low grade heat dryers increasing the “process technology” and “operations/maintenance” risk factors.

10.3.3 End-Use-Specific Risks

The end-use-specific risk matrix is presented in Table 10.4.

CAPITAL REGIONAL DISTRICT

Core Area Wastewater Treatment Program
Biosolids Management Plan

Table 10.4 – End-Use-Specific Risk Matrix

Risk Identification		Risk Assessment			Risk Mitigation
Category	Risk	Probability High = 3; Medium = 2; Low = 1	Impact High = 3; Medium = 2; Low = 1	Risk Factor High >5; Medium 3-4; Low <3	Risk Control Strategies/Actions
Fuel Source					
Cement kiln	Product acceptance	1	3	3	
	Marketability	2	2	4	
	Implementation schedule	1	2	2	
	Transportation	2	2	4	
	Natural disaster	1	3	3	
	Carbon footprint	2	2	4	
Total				20	
WTE #1 (raw, harbour site)	Product acceptance	3	3	9	
	Marketability	1	2	2	
	Implementation schedule	1	2	2	
	Transportation	1	1	1	
	Natural disaster	1	3	3	
	Carbon footprint	2	2	4	
Total				21	
WTE #2 (digested, harbour site)	Product acceptance	3	3	9	
	Marketability	1	2	2	
	Implementation schedule	1	2	2	
	Transportation	1	1	1	
	Natural disaster	1	3	3	
	Carbon footprint	2	2	4	
Total				21	
WTE #3 (raw, Hartland site)	Product acceptance	3	3	9	
	Marketability	1	2	2	
	Implementation schedule	2	2	4	
	Transportation	3	2	6	
	Natural disaster	1	3	3	
	Carbon footprint	2	2	4	
Total				28	

CAPITAL REGIONAL DISTRICT

Core Area Wastewater Treatment Program
Biosolids Management Plan

Table 10.4 – End-Use-Specific Risk Matrix

Risk Identification		Risk Assessment			Risk Mitigation
Category	Risk	Probability High = 3; Medium = 2; Low = 1	Impact High = 3; Medium = 2; Low = 1	Risk Factor High >5; Medium 3-4; Low <3	Risk Control Strategies/Actions
WTE #4 (digested, Hartland site)	Product acceptance	3	3	9	
	Marketability	1	2	2	
	Implementation schedule	2	2	4	
	Transportation	2	2	4	
	Natural disaster	1	3	3	
	Carbon footprint	2	2	4	
Total				26	
Land Beneficial Use					
Fertilizer	Product acceptance	2	3	6	
	Marketability	2	2	4	
	Implementation schedule	2	2	4	
	Transportation	2	1	2	
	Natural disaster	1	3	3	
	Carbon footprint	2	2	4	
Total				23	
Mine reclamation	Product acceptance	1	3	3	
	Marketability	2	2	4	
	Implementation schedule	1	2	2	
	Transportation	2	3	6	
	Natural disaster	1	3	3	
	Carbon footprint	2	2	4	
Total				22	
Land application	Product acceptance	3	3	9	
	Marketability	2	2	4	
	Implementation schedule	3	3	9	
	Transportation	3	2	6	
	Natural disaster	1	3	3	
	Carbon footprint	2	2	4	
Total				35	

CAPITAL REGIONAL DISTRICT

Core Area Wastewater Treatment Program
Biosolids Management Plan

Table 10.4 – End-Use-Specific Risk Matrix

Risk Identification		Risk Assessment			Risk Mitigation
Category	Risk	Probability High = 3; Medium = 2; Low = 1	Impact High = 3; Medium = 2; Low = 1	Risk Factor High >5; Medium 3-4; Low <3	Risk Control Strategies/Actions
Biomass production	Product acceptance	3	3	9	
	Marketability	3	2	6	
	Implementation schedule	3	3	9	
	Transportation	2	2	4	
	Natural disaster	1	3	3	
	Carbon footprint	2	2	4	
Total				35	
Compost product	Product acceptance	2	3	6	
	Marketability	2	2	4	
	Implementation schedule	2	2	4	
	Transportation	2	2	4	
	Natural disaster	1	3	3	
	Carbon footprint	2	2	4	
Total				25	
Topsoil	Product acceptance	2	3	6	
	Marketability	2	2	4	
	Implementation schedule	2	2	4	
	Transportation	2	2	4	
	Natural disaster	1	3	3	
	Carbon footprint	2	2	4	
Total				25	

CAPITAL REGIONAL DISTRICT

Core Area Wastewater Treatment Program Biosolids Management Plan

The key drivers for implementing a successful biosolids management program matched to the schedule of the liquid stream capital program and the long-term sustainability of the program are the public acceptance of the end use, the robustness of the end-use market, and the time frame required to get the program up and running. The risks related to these three factors are considered in the “end-use-specific” risk assessment. A comparison of the product acceptance, marketability, and implementation schedule risk factors for each of the evaluated end uses is presented in Figure 10.2.

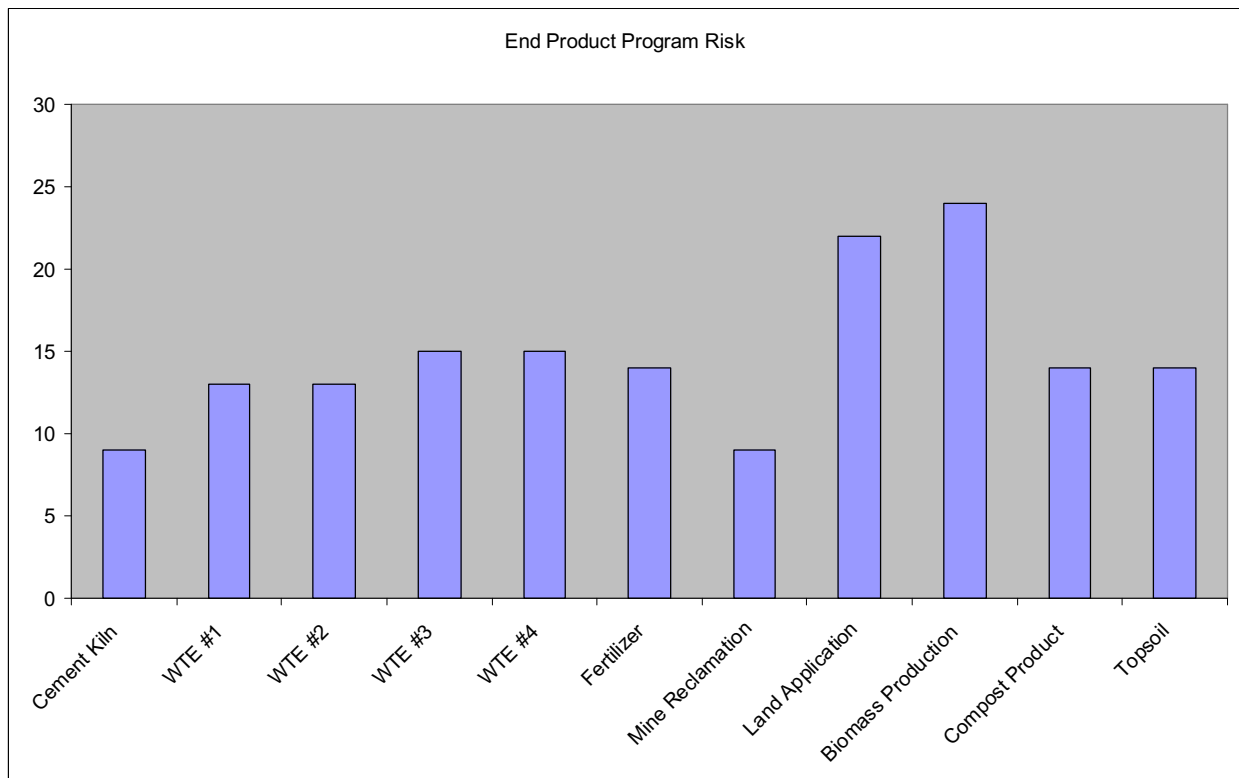

Figure 10.2 – End Product Program Risk

The least-risk end uses are cement kiln fuel and land-based mine reclamation, followed by land-based fertilizer, compost, and topsoil products; the four WTE alternatives, land application, and biomass production carry the highest risk. The WTE alternatives were considered to carry a potential risk of public acceptance due to concerns regarding air pollution of incineration technology.

CAPITAL REGIONAL DISTRICT

Core Area Wastewater Treatment Program
 Biosolids Management Plan

The overall risk of the 11 alternatives is presented in Table 10.5.

Table 10.5 – Alternative Risk Summary

Alternative	Site Risk	Process Risk	End Use Risk	Cumulative Risk
Land-based End Uses				
Mine reclamation	85	51	22	158
Dried fertilizer	85	51	23	159
Compost product	85	51	25	161
Topsoil blend	85	51	25	161
Land application	85	51	35	171
Biomass production	85	51	35	171
Fuel / WTE End Uses				
Cement kiln feed	85	51	20	156
WTE 1 (raw, harbour site)	85	100	21	206
WTE 2 (digested, harbour site)	85	104	21	210
WTE 3 (raw, Hartland site)	131	100	28	259
WTE 4 (digested, Hartland site)	131	104	26	261

The overall least-risk option is utilizing the energy value of dried biosolids as a cement kiln fuel supplement. The overall least-risk option for the land-based end uses is mine reclamation, followed by production of a dried fertilizer; land application and production of biomass carries the highest risk. For the WTE end uses, alternatives 1 and 2 which consolidate all the facilities at the Upper Victoria Harbour site result in the least-risk option—the reduction in risk between WTE 1 and WTE 2 reflects the lower technology risk of handling raw sludge. WTE alternatives 3 and 4 involve facilities at both sites and therefore carry the highest risk. An option that pumped raw sludge from a pumping station located at the liquid stream site thus eliminating the need for the Upper Victoria Harbour site would significantly reduce the site risk factor component of alternatives 3 and 4. As noted above, the presented risk factors have been included in the development of the TBL evaluation presented in Section 11.

Section 11 Triple Bottom Line Analysis

The CRD has adopted the Triple Bottom Line (TBL) evaluation approach to provide a basis for selection of the preferred alternatives being considered as part of its Core Area Wastewater Treatment Program. By understanding the economic, environmental, and social implications of the alternatives that reflect community values, the most long-term sustainable decisions can be made.

Economic impacts are the direct costs to a public agency that are traditionally associated with an economic analysis. Capital costs and potential wastewater resource revenues are considered as well as ongoing operations and maintenance costs. Environmental costs are the environmental implications of an agency's actions that customers place value on. Examples of environmental costs include potential loss of terrestrial resources and potential risks from air emissions. Air pollution may cost a utility not only the fines incurred from regulators, but also the environmental "cost" of pollution. These costs are not typically accounted for in traditional economic analysis for several reasons. Their indirect nature means there is no true direct monetary impact that is measurable by dollar exchange. Secondly, the indirect costs implied are not easily discerned. However, some reasonable assessment allowing comparison of impacts on a common basis is the only way for a true comparison. Like environmental costs, social costs are indirect costs to the community. An example of this is the inconvenience of traffic delays caused by construction. The utility does not directly pay for the "cost" of traffic but its customers may place a value on avoiding unnecessary traffic delays that burn fuel and temporarily hold people up from performing their work.

This section outlines the TBL analysis that was used to evaluate the 11 alternatives for the CRD's Biosolids Management Plan (BMP). The basis for placing value on both direct and indirect costs is detailed and a summary of the evaluation results concludes the section.

11.1 TRIPLE BOTTOM LINE METHODOLOGY

The TBL analysis is built upon prior analyses performed for the Core Area Wastewater Treatment Program (Stantec and Brown and Caldwell, 2009). The list of TBL criteria from prior analyses were largely reused for the biosolids evaluation with some criteria modified to better measure the specific biosolids-related impact. In some cases, an impact was not applicable and was therefore not evaluated. A complete listing of impacts included in the model sorted by the three categories is provided in **Table 11.1**.

CAPITAL REGIONAL DISTRICT

Core Area Wastewater Treatment Program
Biosolids Management Plan

Table 11.1 – Criteria Evaluated for Triple Bottom Line Analysis

Criteria Category	No.	Criteria	Measure Description
Economic	EC-01	Capital Costs	Construction cost and markup for soft costs adjusted to midpoint of construction
	EC-02	Capital Costs Eligible for Grants	Not available at this time
	EC-03	Tax Revenue Implications	Estimated loss of municipal tax revenue
	EC-04	Present Worth of O&M Costs	O&M and R&R costs
	EC-05	Flexibility for Future Treatment Process Optimization	Cost of additional structures needed for process optimization
	EC-06	Expandability for Population Increases	Cost of space needed to expand 100% from current design loads
	EC-07	Flexibility to Accommodate Future Regulations	Cost of additional structures needed to meet potential future regulations
Environmental	EN-01	Carbon Footprint	Value of net eCO ₂ discharged
	EN-02	Heat Recovery Potential	Value of heat recovered and reused
	EN-03	Water Reuse Potential	Not applicable to this evaluation
	EN-04	Biomethane Resource Recovery	Value of recovered biomethane resources
	EN-05	Power (Energy) Usage	Cost of net power consumption
	EN-06	Transmission Reliability	Risk cost of a biosolids transport failure
	EN-07	Site Remediation	Risk cost of site remediation
	EN-08	Pollution Discharge	Cost of pollutants discharged
	EN-09	Nonrenewable Resource Use	Cost of diesel consumption
	EN-10	Nonrenewable Resource Generated	Value of biosolids products
	EN-11	Flexibility for Future Resource Recovery	Cost of space needed to add 100% additional resource recovery
	EN-12	Terrestrial and Intertidal Effect	Cost of habitat areas potentially disturbed
Social	SO-01	Impact of Property Values	Perception of lost value to current property owners
	SO-02	Operations Traffic in Sensitive Areas	Cost of traffic inconvenience during operations
	SO-03	Operations Noise in Sensitive Areas	Cost of noise inconvenience
	SO-04	Odour Potential	Cost of odour issues
	SO-05	Visual Impacts	Cost of lost views
	SO-06	Construction Disruption	Cost of traffic inconvenience during construction
	SO-07	Public and Stakeholder Acceptability	Cost of delays due to lack of public acceptance of end use
	SO-08	Impacts on Future Development	Lost value of developable land adjacent to facility
	SO-09	Loss of Beneficial Site Uses	Lost value of potential park land due to facility
	SO-10	Compatibility with Designated Land Use	Cost of delay due to zoning changes
	SO-11	Cultural Resource Impacts	Risk cost of a cultural site find

CAPITAL REGIONAL DISTRICT

Core Area Wastewater Treatment Program
Biosolids Management Plan

With the criteria identified, the next step in the TBL evaluation was to collect the data required to measure each potential impact. For some impacts, the data needed were obvious (e.g., capital costs were measured using the estimated construction cost); but for others, a surrogate measure was used to represent and capture the majority of the impact (e.g., visual impacts were measured through the perception of loss of value due to a blocked open water or territorial view). The assumptions and values associated with potential impacts for each criterion are included in the following section.

With the data and assumptions collected and documented, the model calculated a value for the impact for each criterion and for each alternative. The results are provided on a summary table and can be presented graphically as well.

11.2 PLACING VALUE ON FACTORS

The foundation of the TBL model is the assumptions and data provided for the calculations. The quality of the data input dictates the quality of the output; consequently, it is important that the correct data are collected. In addition, a monetary value has been assigned to impacts where appropriate—but a majority of the social costs cannot easily be monetized without making some assumption on the value that the agency's customers place on the impact. For example, even with the number of drivers impacted and the delay per driver estimated for construction disruption, a monetary value ultimately depends on the value drivers place on their time. Without feedback from CRD's customers, the values assumed at this time are considered preliminary. In addition, a qualitative scale from 1 to 5 has been included as well to discern a rating difference for different levels of impact.

To document the process, the value associated with each alternative and the data and assumptions for each impact are detailed below. All ultimate values are expressed in dollars as NPV, calculated over a 50-year period from 2015 through 2065. The results and assumptions built into the value of each impact must be given proper scrutiny and constructive feedback will certainly result in more accurate model results.

11.2.1 Economic Criteria

EC-01 Capital Costs

Capital costs measure the construction cost and soft costs for each alternative escalated to the midpoint of construction. Data input included the estimated on-site and off-site construction costs and a 2014 midpoint of construction. For offsite WTE alternatives (in which the majority of the waste is MSW), the capital costs have been factored by the proportion of waste entering the facility that is biosolids so that costs represent only those costs associated with biosolids. This is necessary to compare alternatives on an "apples-to-apples" basis. A similar scaling was done for other impacts for which biosolids only accounted for a portion of the cost or benefit.

CAPITAL REGIONAL DISTRICT

Core Area Wastewater Treatment Program
Biosolids Management Plan

Assumptions included an inflation rate of 3%. The scoring for capital costs was scaled based on the NPV of costs for all alternatives with an NPV of \$250 million assigned a rating of 3 points, higher NPVs worth fewer points, and lower NPVs worth more.

EC-02 Capital Costs Eligible for Grants

This impact was intended to measure the value of grants to offset construction costs, but at this time, insufficient information is available to adequately account for this impact.

EC-03 Tax Revenue Implications

The construction of a biosolids facility will remove some property from the community tax base and result in lost property tax revenues. The NPV of property tax revenues lost was calculated by multiplying the land purchase price for an assumed Victoria Inner Harbour site by the surrounding mill rate. In this impact as well as others, the implications of the site area on the Hartland landfill for a WTE facility were not included as the land is already owned by the CRD. A qualitative 1 to 5 score was scaled based on the cost of lost tax revenue as shown below.

EC-03 Scoring:	
1	More than \$3 million
2	\$2.5 million to \$3 million
3	\$2 million to \$2.5 million
4	\$1.5 million to \$2 million
5	Less than \$1.5 million

EC-04 Present Worth Costs

Present worth included annual expenditures for O&M and for replacement and refurbishment (R&R) projects. Data input included annual on-site and off-site O&M and R&R costs. Assumptions included a 3% rate of inflation for each annual cost. The scoring was scaled based on the NPV of all alternatives with a NPV of \$300 million worth 3 points, a higher NPV worth fewer points, and lower NPV worth more.

EC-05 Flexibility for Future Treatment Process Optimization

This impact was intended to measure the flexibility for each alternative to allow for new process optimizations not yet developed. To measure this, the portion of construction costs spent on facility structures was compared for each alternative and a "Process Optimization Factor" was estimated based on the process type used. A smaller Process Optimization Factor indicates more flexibility for optimization. The cost for additional structures at each site was multiplied by the Process Optimization Factor and each alternative was scored using the following scale.

CAPITAL REGIONAL DISTRICT

Core Area Wastewater Treatment Program
Biosolids Management Plan

EC-05 Scoring:	
1	More than \$35 million
2	\$25 million to \$35 million
3	\$15 million to \$25 million
4	\$5 million to \$15 million
5	Less than \$5 million

EC-06 Expandability for Population Increases

Population increases will result in additional facility site needed to expand capacity. The data input for this impact was the amount of site area used for each alternative with a thermal drying process using more area than digestion and both of these processes using more than a dewatering facility. Some alternatives include digestion and some do not and the size of dewatering and drying facilities varies depending on the alternative. The additional site space required to double treatment capacity was based on an assumed expansion coefficient and the cost of additional space was assumed to be \$2 million per hectare. No additional cost was assumed at Hartland landfill as it is already owned by the CRD. The cost of expansion for each alternative was scored as follows.

EC-06 Scoring:	
1	More than \$7 million
2	\$5 million to \$7 million
3	\$3 million to \$5 million
4	\$1 million to \$3 million
5	Less than \$1 million

EC-07 Flexibility to Accommodate Future Regulations

Like treatment process optimization, stricter regulations will probably require more process structures. Construction costs on process structures and the Process Optimization Factor described in EC-06 were used as the data input for this impact. Assumptions included a probability of stricter regulations for each alternative. A NPV was calculated for each alternative and scored based on the following scale.

EC-07 Scoring:	
1	More than \$7 million
2	\$5 million to \$7 million
3	\$3 million to \$5 million
4	\$1 million to \$3 million
5	Less than \$1 million

11.2.2 Environmental Impacts

EN-01 Carbon Footprint

The details of the carbon footprint calculation have been presented in Section 8. Scoring was based on the NPV of offsets for equivalent tonnes of CO₂ emitted (assuming \$25 per tonne) using the following scale.

EN-01 Scoring:	
1	More than \$5 million
2	\$0 to \$5 million
3	-\$5 million to \$0 million
4	-\$10 million to -\$5 million
5	Less than -\$10 million

EN-02 Heat Recovery Potential

This impact measures the potential amount of heat energy recovered and used for process heating that would otherwise have been wasted. Data inputs include projected heating loads, a \$10/GJ value of recovered heat, and a 0.38% growth rate. A 5% rate of inflation for heat value was assumed. The NPV for each alternative was calculated and compared using the following scale. Recovered heat is used in alternatives for digester heating, building heating, and biosolids drying.

EN-02 Scoring:	
1	Less than \$10 million
2	\$10 million to \$40 million
3	\$40 million to \$60 million
4	\$60 million to \$80 million
5	More than \$80 million

EN-03 Water Reuse Potential

Water reuse is not applicable to evaluating biosolids management and was therefore not included in this evaluation.

CAPITAL REGIONAL DISTRICT

Core Area Wastewater Treatment Program
Biosolids Management Plan

EN-04 Biomethane Production

Biomethane production was assumed to offset use of natural gas. In addition, tipping fees from co-digestion substrate were included as part of this impact. The data inputs for this impact were the volume of biomethane recovered, the annual volume of substrate tipping revenue, a \$0.035 per litre tipping fee, a \$10/GJ value of natural gas, and a 0.38% growth rate. A 5% inflation rate for natural gas costs was assumed. The NPV for each alternative was calculated and compared using the following scale.

EN-04 Scoring:	
1	Less than \$10 million
2	\$10 million to \$40 million
3	\$40 million to \$70 million
4	\$ 70 million to \$100 million
5	More than \$100 million

EN-05 Power (Energy) Use

This impact compared the net electrical energy consumed for each alternative. For WTE alternatives, power consumption was offset by the power generated in the WTE process. Data input included annual net power consumption, a \$0.08/kW-hr cost of power consumed, a \$0.065/kW-hr value for power produced, and a 0.38% growth rate. Assumptions included a 3% rate of inflation for power costs. The NPV for electrical costs was calculated for each alternative and then scaled as follows.

EN-05 Scoring:	
1	More than \$100 million
2	\$70 million to \$100 million
3	\$40 million to \$70 million
4	\$10 million to \$40 million
5	Less than \$10 million

EN-06 Transmission Reliability

This impact measures the relative risk carried for each alternative in terms of a transportation failure. Data input were the number of biosolids truck loads required for each alternative and the distance driven for each load. Each alternative was compared by multiplying the number of trips required by the distance travelled. A \$1 risk cost was assumed for transported solids. The NPV for transmission risk was calculated for each alternative and the following scale was used.

CAPITAL REGIONAL DISTRICT

Core Area Wastewater Treatment Program
Biosolids Management Plan

EN-06 Scoring:

1	More than \$2 million
2	\$1.5 million to \$2 million
3	\$1 million to \$1.5 million
4	\$500,000 to \$1 million
5	Less than \$500,000

EN-07 Site Remediation

Site remediation could significantly increase construction costs. To measure this, the direct cost of remediation, the potential delay due to remediation, and the estimated construction cost were used as data inputs. Assumptions included a 3% inflation rate, a \$300,000 remediation cost per hectare, and a probability of remediation at an Upper Victoria Harbour site. The risk cost of remediation activities was calculated for each alternative, the NPV was evaluated, and each alternative was compared using the following scale.

EN-07 Scoring:

1	More than \$11 million
2	\$8 million to \$11 million
3	\$5 million to \$8 million
4	\$2 million to \$5 million
5	Less than \$2 million

EN-08 Pollution Discharge

Pollution discharged measured the mass volume of pollutants emitted for each alternative. Three pollutants were used as surrogates to evaluate pollution loads: lead, mercury, and nitrous oxides (NO_x). These represent compounds that are either retained in soil or created or volatilized during combustion. For alternatives in which the final product was applied to the land, the annual volume of lead and mercury leaving the facility were used to measure pollution and were valued at \$100/kg. For alternatives in which combustion was used, the mass of NO_x emitted was valued at \$1/kg, lead sent to the landfill as fly ash was valued at \$50/kg, and mercury volatilized in the exhaust was valued at \$200/kg. The NPV was calculated for each alternative and the following 1 to 5 scale was used to compare the alternatives.

EN-08 Scoring:

1	More than \$2 million
2	\$1.5 million to \$2 million
3	\$1 million to \$1.5 million
4	\$500,000 to \$1 million
5	Less than \$500,000

CAPITAL REGIONAL DISTRICT

Core Area Wastewater Treatment Program
Biosolids Management Plan

EN-09 Nonrenewable Resource Use

This impact measured diesel fuel consumption during construction and operations, including sludge transport. Diesel consumption during construction was assumed to be 2% of construction costs. Diesel consumption during operations was calculated by multiplying the number of truck loads by the distance travelled, assuming a 2.13 km per litre fuel efficiency and a \$2 cost per litre of diesel. A 5% inflation rate was assumed and a NPV was calculated for each alternative. The alternatives were scored using the scale below.

EN-09 Scoring:	
1	More than \$11 million
2	\$8 million to \$11 million
3	\$5 million to \$8 million
4	\$2 million to \$5 million
5	Less than \$2 million

EN-10 Nonrenewable Resource Generated

Nonrenewable resource generated measured the struvite and biosolids production for each alternative. Data input included the volume of struvite and biosolids produced. The value of struvite was assumed to be \$1,200/tonne. Biosolids used for cement kiln fuel was assumed to generate \$29/tonne of revenue, top soil amendment was valued at \$50/tonne, a compost product was valued at \$53/tonne, biomass product was assumed to generate \$8/tonne, and a dried fertilizer was assumed to generate \$29/tonne. Biosolids used for mine reclamation and land application were assumed to generate no net revenue. The NPV based on annual revenue for each alternative was calculated and scores were given based on the following scale.

EN-10 Scoring:	
1	Less than \$5 million
2	\$5 million to \$10 million
3	\$10 million to \$15 million
4	\$15 million to \$20 million
5	More than \$20 million

CAPITAL REGIONAL DISTRICT

Core Area Wastewater Treatment Program
Biosolids Management Plan

EN-11 Flexibility for Future Resource Recovery

Future resource recovery was measured by the available space for additional solids treatment process structures. Data input included planned site area used. Assumed were a 100% increase in used hectares for future solids treatment and a \$2 million per hectare cost for additional site space. The cost for expansion was calculated for each alternative and scored using the following scale.

EN-11 Scoring:	
1	More than \$7 million
2	\$5 million to \$7 million
3	\$3 million to \$5 million
4	\$1 million to \$3 million
5	Less than \$1 million

EN-12 Terrestrial and Intertidal Habitat Impacts

This measure was intended to measure the impact siting would have on existing terrestrial and intertidal habitats. Sensitive areas were based on maps in the CRD's Harbours Atlas; no sensitive areas were identified surrounding the Upper Victoria Harbour site or the Hartland landfill site. The following scale was used assuming a \$1 million cost per habitat impacted.

EN-12 Scoring:	
1	More than \$5 million
2	\$4 million to \$5 million
3	\$3 million to \$4 million
4	\$2 million to \$3 million
5	Less than \$2 million

11.2.3 Social Impacts

SO-01 Impact on Property Values

Lost values for existing private properties are not expected but a perception of lost value constitutes a social cost. This impact was measured by assuming that the residents within a 500-m radius within each site would be perceived to lose 1% of an assumed average value of \$500,000. Because the Upper Victoria Harbour site is already an industrial area, the existing property within 500 m was assumed to be unaffected by the addition of a biosolids facility. The societal impact was calculated by multiplying the number of residential parcels that were impacted by \$5,000 and scored as shown below.

SO-01 Scoring:	
1	More than \$1.5 million
2	\$1 million to \$1.5 million
3	\$500,000 to \$1 million
4	\$0 to \$500,000
5	No anticipated impact

SO-02 Operations Traffic in Sensitive Areas

The intent of this measure was to capture the impact of operations traffic on existing traffic. This impact was measured using the traffic counts from CRD's 2005 evaluation near each site area and the number of solids hauling trips required each year. The cost of a commuter impacted by an operations trip was estimated as \$0.50 and the probability of this cost being incurred was assumed to be 1%. Thus, a cost for operations traffic was calculated, the NPV was determined, and each alternative was evaluated using the following scale.

SO-02 Scoring:	
1	More than \$2 million
2	\$1.5 million to \$2 million
3	\$1 million to \$1.5 million
4	\$500,000 to \$1 million
5	Less than \$500,000

SO-03 Operations Noise in Sensitive Areas

Noise due to operations is a societal cost on nearby residents and businesses. To capture this cost, it was assumed that only residential parcels within 500 metres of each site could be potentially impacted by noise. Because the Upper Victoria Harbour site is already an industrial area, the noise created by the addition of a biosolids facility was assumed to not impact any residences within 500 metres. To capture the scale of the cost of noise, 1% of property value was used as a surrogate and a \$500,000 average property value was assumed. Each alternative was given a qualitative 1 to 5 score as shown below.

SO-03 Scoring:	
1	More than \$1.5 million
2	\$1 million to \$1.5 million
3	\$500,000 to \$1 million
4	\$0 to \$500,000
5	No anticipated impact

SO-04 Odour Potential

Odour can be a nuisance to nearby residents and businesses. To capture this impact, the residences and businesses potentially impacted by odour were assumed to be those within 500 metres of each site. As with noise impacts, odour costs were measured using home values as a surrogate but unlike noise, odour was assumed to impact existing industrial sites near an Inner Harbour site. For each site, the number of residential equivalents within 500 m was estimated, a \$500,000 average value was assumed, and 25% of property value was assumed as a potential impact/mitigation level for odour issues. Thus, a cost for odour issues was calculated and a qualitative 1 to 5 score was given as shown below.

SO-04 Scoring:	
1	More than \$35 million
2	\$25 million to \$35 million
3	\$15 million to \$25 million
4	\$5 million to \$15 million
5	Less than \$5 million

CAPITAL REGIONAL DISTRICT

Core Area Wastewater Treatment Program
Biosolids Management Plan

SO-05 Visual Impacts

The loss of open water or territorial view or the addition of a biosolids facility to an otherwise open view is a loss for the community. This impact was measured by estimating the number of residences within 500 m of each site and assuming a view would be worth 2% of a \$500,000 average home value. Because the Inner Harbour site is already an industrial area, the view for existing property was assumed to be unaffected by the addition of a biosolids facility. The cost of each alternative was calculated and compared using the following scale.

SO-05 Scoring:	
1	More than \$1.5 million
2	\$1 million to \$1.5 million
3	\$500,000 to \$1 million
4	\$0 to \$500,000
5	No anticipated impact

SO-06 Construction Disruption

Traffic during construction can be a particular nuisance to neighbouring residents and businesses. To measure this disruption, the volume of traffic potentially impacted by plant construction was estimated by using traffic counts at nearby intersections for each site. These traffic counts came from CRD's 2005 evaluations. The number of construction trips was calculated by estimating one construction trip per day for every \$2,500 of construction budget. The traffic count was multiplied by the daily construction traffic at each site and a plant construction disruption cost was calculated assuming a \$1 cost per trip delayed and a 1% probability of delay due to construction. Each alternative was evaluated and a qualitative 1 to 5 score was given based on the scale shown below.

SO-06 Scoring:	
1	More than \$35 million
2	\$25 million to \$35 million
3	\$15 million to \$25 million
4	\$5 million to \$15 million
5	Less than \$5 million

SO-07 Public and Stakeholder Acceptability

Delays caused by a lack of public acceptance of the end use could be costly during the construction period. A 4-year delay was assumed for each alternative and the construction cost was delayed by that number with a 3% inflation rate. A probability of delay was assumed for each alternatives and the following scale was used to compare the risk of delay costs for each alternative.

CAPITAL REGIONAL DISTRICT

Core Area Wastewater Treatment Program
Biosolids Management Plan

SO-07 Scoring:	
1	More than \$28 million
2	\$21 million to \$28 million
3	\$14 million to \$21 million
4	\$7 million to \$14 million
5	Less than \$7 million

SO-08 Impacts on Future Development

Future development in undeveloped areas near treatment sites could be hindered due to the presence of a treatment facility. To capture this cost, it was assumed that a percentage of the number of undeveloped hectares within 2 kilometres would be impacted. Furthermore, a \$200,000 cost per hectare was assumed to be lost for future development. In addition the assumed percentage of undeveloped land that could be impacted was estimated and used to factor the value of impact. The value lost at each site was calculated and compared using the following scale.

SO-08 Scoring:	
1	More than \$15 million
2	\$10 million to \$15 million
3	\$5 million to \$10 million
4	\$0 to \$5 million
5	No Impact

SO-09 Loss of Beneficial Site Use

The addition of a biosolids facility may preclude the use of the site as an open space or park land. To measure this impact, the number of hectares of potential park or open space lost due to an Upper Victoria Harbour site was estimated and an assumption of a \$1,000,000 per hectare incremental value for using the site as a park instead of a solids treatment facility was assumed. The scale used to compare alternatives is presented below.

SO-09 Scoring:	
1	More than \$3 million
2	\$2.3 million to \$3 million
3	\$1.5 million to \$2.3 million
4	\$700,000 to \$1.5 million
5	Less than \$700,000

CAPITAL REGIONAL DISTRICT

Core Area Wastewater Treatment Program
Biosolids Management Plan

SO-10 Compatibility with Designated Land Use

Converting site zoning to allow for a biosolids facility can delay the overall construction schedule as various municipal offices are involved. This delay was assumed to be 6 months and each alternative's construction cost was escalated at an assumed 3% inflation rate. The cost of this delay was then compared for each alternative using the scale below.

SO-10 Scoring:	
1	More than \$7 million
2	\$5 million to \$7 million
3	\$3 million to \$5 million
4	\$1 million to \$3 million
5	Less than \$1 million

SO-11 Cultural Resource Impacts

A cultural resource find would cause additional cost and delay to site construction. A 5% probability of a cultural find and a 1-year delay was assumed for each alternative. The estimated construction cost was escalated at an assumed 3% inflation rate to capture the cost of this delay. By multiplying the delay cost by the probability of a find, the risk cost of a cultural find was calculated for each alternative and compared using the following scale.

SO-11 Scoring:	
1	More than \$700,000
2	\$500,000 to \$700,000
3	\$300,000 to \$500,000
4	\$100,000 to \$300,000
5	Less than \$100,000

11.3 ALTERNATIVE EVALUATION

The numerical scoring of each category in the TBL evaluation for the 11 biosolids alternatives is presented in Table 10.2, and the same information is illustrated graphically in Figure 10.2. The maximum score for each category is 5 and the minimum score is 1. Scoring between the minimum and maximum value was based on whole numbers. A higher score reflects a more favourable outcome of the alternative when considering the specific category. To account for the differing number of categories within the Economic, Environmental, and Social criterion, the categories have been weighted so that the maximum possible score is limited to 100. Within the Economic criteria the individual categories have been weighted in proportion to their respective calculated NPVs. The result of this is to weight capital project cost and the 50-year stream of annual O&M and R&R costs at 8 times the value of the remaining four categories. For the

CAPITAL REGIONAL DISTRICT

Core Area Wastewater Treatment Program
Biosolids Management Plan

Environmental and Social criteria the individual categories were not differentially weighted because the underlying financial analysis that formed the basis for the individual numeric scoring included more subjective inputs as compared to the line items in the Economic criteria group.

The results of scoring the Economic criteria for each alternative are as follows:

Dried fertilizer:	61
Topsoil blend:	59
Mine reclamation:	60
Land application:	60
Biomass production:	58
Compost product:	58
Cement kiln fuel:	62
Onsite WTE (raw):	55
Onsite WTE (digested):	57
Offsite WTE (raw):	57
Offsite WTE (digested):	59

A dried fertilizer product and cement kiln fuel scored the highest for these criteria based on a lower annual O&M costs. The WTE alternatives scored relatively low due mainly to the high capital and O&M costs associated with constructing and operating both a biosolids treatment facility and a facility for combustion.

The results of scoring the Environmental criteria for each alternative are as follows:

Dried fertilizer:	75
Topsoil blend:	76
Mine reclamation:	66
Land application:	69
Biomass production:	64
Compost product:	76
Cement kiln fuel:	75
Onsite WTE (raw):	66
Onsite WTE (digested):	73
Offsite WTE (raw):	64
Offsite WTE (digested):	73

The main reason that top soil blend and compost product scored the highest is the relatively higher value associated with selling the biosolids as compared to the other alternatives. This fact impacted EN-10, Nonrenewable Resource Generated. Overall, the Environmental scores are higher than the Economic scores because of the relatively high level of resource recovery and reduced carbon footprint for each alternative.

CAPITAL REGIONAL DISTRICT

Core Area Wastewater Treatment Program
Biosolids Management Plan

The results of scoring the Social criteria for each alternative are as follows:

Dried fertilizer:	73
Topsoil blend:	73
Mine reclamation:	75
Land application:	71
Biomass production:	71
Compost product:	73
Cement kiln fuel:	75
Onsite WTE (raw):	73
Onsite WTE (digested):	73
Offsite WTE (raw):	56
Offsite WTE (digested):	60

All of the alternatives scored relatively close to each other with 7 of the 11 alternatives scoring between 73 and 75. This is mainly because every alternative requires the same Upper Victoria Harbour site and its associated social costs. The cement kiln and mine reclamation alternatives scored comparatively higher because of the reduced risk cost of a delay due to a public rejection of the end use product. This impacted the score for SO-07 Public and Stakeholder Acceptability. The overall points allocation for the Social criteria was higher than for the Economic scoring, reflecting the fairly low social cost of the alternatives because the Upper Victoria Harbour siting would be for an industrial facility within an area that is already largely industrial.

When the three criteria groups are summed, the resulting TBL scores for the 11 alternatives are as follows:

Dried fertilizer:	209
Topsoil blend:	208
Mine reclamation:	200
Land application:	200
Biomass production:	193
Compost product:	207
Cement kiln fuel:	212
Onsite WTE (raw):	193
Onsite WTE (digested):	203
Offsite WTE (raw):	178
Offsite WTE (digested):	192

The TBL analysis ranks a topsoil blend, a dried fertilizer product, and a cement kiln fuel as the preferred alternatives.

CAPITAL REGIONAL DISTRICT
 Core Area Wastewater Treatment Program
 Biosolids Management Plan

Table 11.2 – Summary Table of TBL Analysis Results

Criteria Group	No.	Criteria Categories	Measure Description	Weight	Alternative Results										Comments	
					Dried Fertilizer	Top Soil Blend	Mine Reclamation	Land Application	Biomass Production	Compost Product	Cement Kiln Fuel	WTE - A	WTE - B	WTE - C		WTE - D
Economic	EC-01	Capital Costs	construction cost and markup for soft costs adjusted to midpoint of construction	8	2.9	2.9	2.9	2.9	2.9	2.9	2.9	2.8	2.6	3.0	2.8	Costs included for resource recovery systems
	EC-02	Capital Costs Eligible for Grants	Not available at this time	-	-	-	-	-	-	-	-	-	-	-	-	
	EC-03	Tax Revenue Implications	cost of private property lost and lost revenue from reduced property values	1	3	3	3	3	3	3	3	3	3	3	3	
	EC-04	Present Worth of O&M costs	O&M costs	8	3.2	3.0	3.1	3.1	2.9	2.8	3.2	3	3	3	3	Costs included for resource recovery systems
	EC-05	Flexibility for Future Treatment Process Optimization	cost of additional tankage needed for process optimization	1	3	3	3	3	3	3	3	1	3	1	3	
	EC-06	Expandability for Population Increases	additional space needed versus available to meet 2065 loading	1	3	3	2	2	2	3	3	4	3	5	3	
	EC-07	Flexibility to Accommodate Future Regulations	available to meet potential regulations	1	3	3	4	4	4	3	4	2	4	2	4	
Economic Subtotal (100 pts max)¹:					61	59	60	60	58	58	62	55	57	57	59	
Environmental	EN-01	Carbon Footprint	tons of eCO2 created	1.82	4	4	5	4	4	4	4	2	3	2	3	
	EN-02	Heat Recovery Potential	Heat energy replacing natural gas	1.82	4	4	4	4	4	4	4	5	4	5	4	
	EN-03	Water Reuse Potential	not applicable to this analysis	-	-	-	-	-	-	-	-	-	-	-	-	
	EN-04	Biomethane Resource Recovery	Recovery of biomethane resources	1.82	5	5	5	5	5	5	5	1	5	1	5	
	EN-05	Power (energy) usage or generation	kilowatt hours per year consumed	1.82	2	2	2	2	2	2	2	4	3	4	3	Cost also included in EC-04
	EN-06	Transmission Reliability	risk cost of transmission failure	1.82	5	5	2	4	2	5	5	5	5	4	5	
	EN-07	Site Remediation	risk cost of site remediation	1.82	3	3	3	3	3	3	3	3	3	3	3	
	EN-08	Pollution Discharge	air emissions discharged	1.82	3	3	3	3	3	3	3	3	3	3	3	
	EN-09	Non-renewable Resource Use	Gallons of diesel consumed per year	1.82	3	3	1	2	1	3	3	3	3	2	3	Cost also included in EC-04
	EN-10	Non-renewable Resource Generated	Biosolids production	1.82	4	5	3	3	3	5	4	1	3	1	3	
	EN-11	Flexibility for Future Resource Recovery	Additional space needed to add 100% additional resource recovery	1.82	3	3	3	3	3	3	3	4	3	5	3	
	EN-12	Terrestrial and Inter-tidal Effect	Habitat areas potentially disturbed	1.82	5	5	5	5	5	5	5	5	5	5	5	
Environmental Subtotal (100 pts max):					75	76	66	69	64	76	75	66	73	64	73	
Social	SO-01	Impact on Property Values	Lost value to present community	1.82	5	5	5	5	5	5	5	5	5	4	4	
	SO-02	Operations Traffic in Sensitive Areas	Cost of traffic inconvenience during operations	1.82	4	4	4	4	4	4	4	5	5	2	4	
	SO-03	Operations Noise in Sensitive Areas	Cost of noise inconvenience	1.82	5	5	5	5	5	5	5	5	5	4	4	
	SO-04	Odour Potential	Cost of odour issues	1.82	3	3	3	3	3	3	3	3	3	2	2	
	SO-05	Visual Impacts	Perceived value of lost view	1.82	5	5	5	5	5	5	5	5	5	4	4	
	SO-06	Construction Disruption	Cost of traffic inconvenience due to construction	1.82	3	3	3	3	3	3	3	3	3	3	3	
	SO-07	Public and Stakeholder Acceptability	Lost time due to public disapproval	1.82	3	3	4	2	2	3	4	2	2	2	2	
	SO-08	Impacts on Future Development	Loss of value of developable land adjacent to facility	1.82	3	3	3	3	3	3	3	3	3	1	1	
	SO-09	Loss of Beneficial Site Uses	Loss of park land due to facility	1.82	3	3	3	3	3	3	3	3	3	3	3	
	SO-10	Compatibility with Designated Land Use	Delay due to zoning changes	1.82	3	3	3	3	3	3	3	3	3	3	3	
	SO-11	Cultural Resource Impacts	Risk cost of a cultural site find	1.82	3	3	3	3	3	3	3	3	3	3	3	
Social Subtotal (100 pts max):					73	73	75	71	71	73	75	73	73	56	60	
TOTAL SCORE (300 pts max):					209	208	200	200	193	207	212	193	203	178	192	

1 - Economic weighting is proportional to NPV results

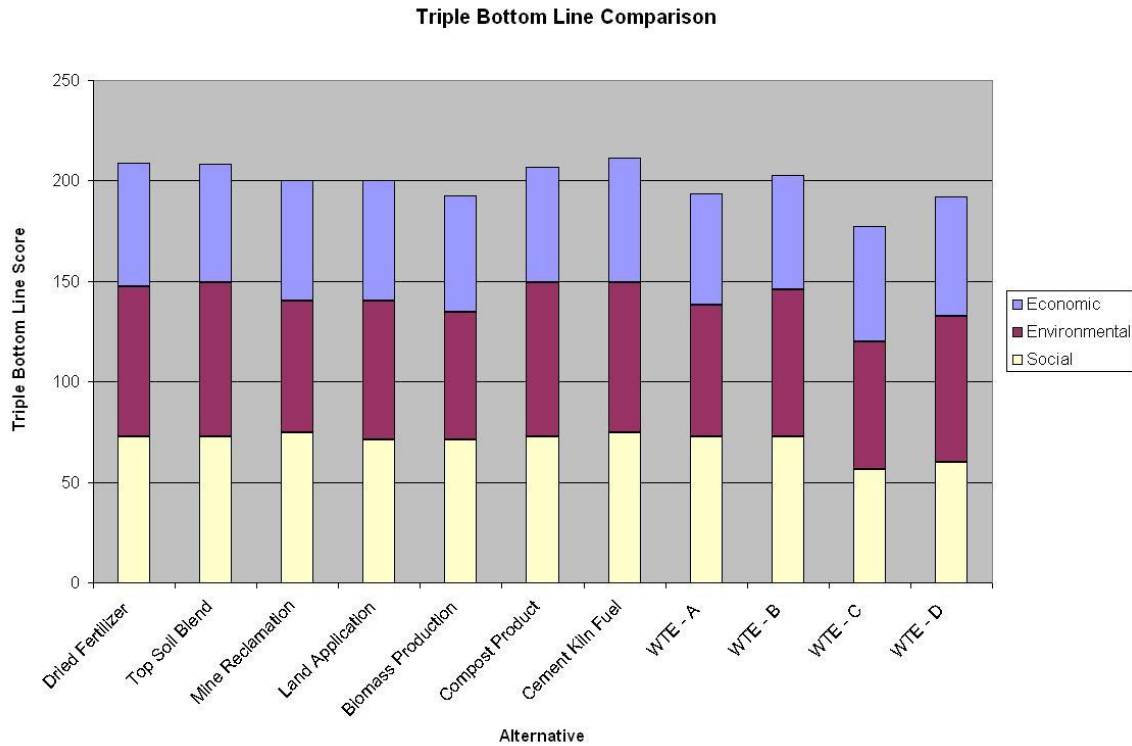

Figure 11.2 – Graphical Results of TBL Analysis

11.4 REFERENCES

Stantec Consulting Ltd./Brown and Caldwell, Core Area Wastewater Treatment Assessment of Wastewater Treatment Options 1A, 1B and 1C for the Capital Regional District, September 16, 2009.

Section 12 Findings and Recommendations

This section lists the principal conclusions and recommendations with respect to the CRD Core Area Wastewater Treatment Program biosolids management alternatives. A complete array of biosolids management alternatives have been investigated, including eleven alternatives carried through detailed costing and triple bottom line evaluation.

The major objectives of the CRD biosolids management program were discussed in Section 2 of this BMP. Alternatives are recommended that achieve the following objectives:

- Have the potential to utilize or dispose of all biosolids loads through 2030
- Utilize technologies that support the ultimate utilization/disposal
- Can be implemented within the required schedule (2016)
- Provide maximum resource recovery
- Reduce GHG emissions
- Integrate with solid waste management
- Provide end-use reliability: primary and backup alternatives
- Utilize technologies that can be constructed at a reasonable cost and have an acceptable operating and life-cycle cost
- Provide process reliability: proven technology
- Meet all regulatory requirements.

A successful, comprehensive management program will address all of these objectives. However, any single ultimate disposal/utilization alternative may not meet all objectives. Instead, a blend of alternatives is recommended to meet all objectives. Some of these objectives are appropriately relevant to the end-use/disposal alternatives, some to backup alternatives, whereas some are more specifically relevant to the technology or hardware used for preparing the biosolids for end-use.

The CRD is fortunate to have several good options available to them. A number of excellent opportunities exist for integration of biosolids management with the municipal solid waste management, including co-digestion to capture gas and waste-to-energy combustion to produce power. In addition, Hartland landfill will play a key role in future biosolids management by acting as a backup to beneficial use options. The following sections list other conclusions and recommendations from this evaluation.

12.1 CONCLUSIONS

The following is a list of conclusions from the Core Area Wastewater Treatment Program Biosolids Management Plan:

1. A wide array of beneficial biosolids use options are available to the CRD that reduce GHG emissions, and recover energy and other resources.
2. Hartland landfill provides an important ready-made backup alternative for emergency situations.
3. Some biosolids utilization alternatives (e.g., cement kiln fuel) have more immediate implementation potential than others.
4. Biosolids program diversity is desirable in the long term to provide reliability and maximize revenue return.
5. Class A dried biosolids product maximizes future program flexibility and diversity.
6. With the diverse market approach, all markets do not need to be fully developed at the time of startup. Similar markets are viable in other communities and there is a high probability that similar markets can be developed with proper management over time for the CRD service area.
7. Biosolids alternatives with digestion and biomethane sale have significant benefits in terms of offsetting GHG emissions from fossil fuels and reducing carbon footprint for CRD.
8. There is significant benefit to co-digesting source separated organics, including FOG and food waste with biosolids.
9. A cost effective, comprehensive plan for management of the biosolids generated at the future wastewater treatment facilities would consist of thermophilic co-digestion, dewatering, drying, and beneficial use of the dried biosolids product. The best blend of beneficial use options based on lowest cost, best TBL ratings, and lowest risk include:
 - Fuel for cement kilns or other existing coal-powered plants
 - Sale as a dried fertilizer product
 - Preparation and sale of a blended soil amendment
 - Application to mines or other degraded lands for reclamation

All of these reuse management opportunities are susceptible to market variations, so a blend of these options would provide the highest level of product utilization diversity and reliability. It is also important that a back-up plan for disposal of a portion or all of the production by landfill at the Hartland Road landfill be retained. This comprehensive program could be constructed and operated for about \$260 million in capital and about \$7 million annual operating costs, lower than all other options considered.

CAPITAL REGIONAL DISTRICT

Core Area Wastewater Treatment Program Biosolids Management Plan

10. Agricultural land application, biomass production (willow coppice), and composting were the lowest rated and highest cost of the biosolids product beneficial use alternatives and should be considered second-tier options after the options described above.
11. Piloting of a biocell landfill operation has significant environmental benefit to lengthen the life of the landfill and to reduce GHG emissions should continued landfilling of degradable organic MSW be necessary.
12. Integration of biosolids and residual solid wastes in a staged WTE facility has potential to provide significant benefits to CRD. In addition to the benefits from the biosolids discussed in this report, benefits accruing to the MSW would include revenue from sale of electrical energy, overall reduction of green house gases, as well as: extension of the landfill useful life and potential for heat recovery and eventually materials recovery.
13. The CRD has retained a separate consultant to examine the feasibility of providing a WTE facility for the 100000 tpy of residual solid wastes that are expected following recycling and once organic waste separation is fully implemented. If a combined biosolids and MSW WTE facility were established, it could be the first stage of a regional WTE facility. The synergies of a combined biosolids / MSW WTE facility should be investigated further.

12.2 RECOMMENDATIONS

The following is a list of recommendations from the Core Area Wastewater Treatment Program Biosolids Management Plan:

1. From 50% to 90% of biosolids product should be initially directed to cement kiln fuel, preserving options for diverting dried product to other beneficial uses in the future.
2. Work with cement manufacturers in advance of WWTP construction to confirm dried biosolids product requirements and performance, if possible, providing comparable product from another source for testing.
3. In addition to cement kiln use, biosolids should be further used to develop a diverse program including topsoil product blending, dried fertilizer product, and mine reclamation. The CRD should pursue partnerships with private sector companies including topsoil blenders, providing product from outside the area for performance trials during WWTP design and construction.
4. Hire a professional Biosolids Manager well before treatment facilities are on line to develop the program and associated relationships, markets, testing, and support team. This will enhance the ability to beneficially use the maximize quantity of biosolids and provide maximum program diversity from the first day of operation.
5. Partner with academic institutions (e.g. University of Victoria, University of British Columbia, etc.) to develop research and pilot programs that can benefit the technical support of the comprehensive biosolids utilization options.
6. Implement and evaluate a demonstration, pilot-scale biocell program at the Hartland landfill considering benefits in GHG reduction and energy recovery.

CAPITAL REGIONAL DISTRICT

Core Area Wastewater Treatment Program Biosolids Management Plan

7. There is significant benefit to co-digesting food waste with biosolids. The CRD should proceed to investigate the best strategy for handling food waste strictly from a MSW perspective. This further study should compare costs and benefits of digestion of food waste together with or separate from biosolids and compare these options to other beneficial alternatives such as food waste composting.
8. This Biosolids Management Plan evaluates the costs and benefits for handling biosolids with and without MSW. It does not fully address the costs and benefits of alternatives for handling solid waste by itself. The next step in evaluating the potential for integration of biosolids with MSW would be the development of a comparable Municipal Solid Waste Management Plan that addresses the issues from the MSW perspective. As an example, a thorough analysis of MSW options such as waste-to-energy compared to options such as enhanced landfill encapsulation and gas recovery would provide direction to the CRD with respect to desired future direction for MSW. Integration of MSW and biosolids handling in the end may include combining handling of the two waste streams or it may prove the optimum to handle portions of the waste streams separately to take advantage of their respective characteristics and benefits.
9. With potential benefits and risks from co-funding a WTE facility, the CRD should consider selecting the higher cost alternative of building a first phase WTE facility discussed in Appendix B. If this consideration concludes that funding can be secured and the analysis of other MSW options discussed above confirms the benefits of WTE, proceed to implement the first stage of an integrated WTE biosolids/MSW facility.

Criteria Group	No.	Criteria Categories	Measure Description	Weight	Alternative Results										Comments		
					Dried Fertilizer	Top Soil Blend	Mine Reclamation	Land Application	Biomass Production	Compost Product	Cement Kiln Fuel	WTE - A	WTE - B	WTE - C		WTE - D	
Economic	EC-01	Capital Costs	construction cost and markup for soft costs adjusted to midpoint of construction	8	2.9	2.9	2.9	2.9	2.9	2.9	2.9	2.8	2.6	3.0	2.8	Costs included for resource recovery systems	
	EC-02	Capital Costs Eligible for Grants	Not available at this time	-	-	-	-	-	-	-	-	-	-	-	-		
	EC-03	Tax Revenue Implications	cost of private property lost and lost revenue from reduced property values	1	3	3	3	3	3	3	3	3	3	3	3		
	EC-04	Present Worth of O&M costs	O&M costs	8	3.2	3.0	3.1	3.1	2.9	2.8	3.2	3	3	3	3		Costs included for resource recovery systems
	EC-05	Flexibility for Future Treatment Process Optimization	cost of additional tankage needed for process optimization	1	3	3	3	3	3	3	3	1	3	1	3		
	EC-06	Expandability for Population Increases	additional space needed versus available to meet 2065 loading	1	3	3	2	2	2	3	3	4	3	5	3		
	EC-07	Flexibility to Accommodate Future Regulations	additional space needed versus available to meet potential regulations	1	3	3	4	4	4	3	4	2	4	2	4		
Economic Subtotal (100 pts max):					61	59	60	60	58	58	62	55	57	57	59		
Environmental	EN-01	Carbon Footprint	tons of eCO2 created	1.82	4	4	5	4	4	4	4	2	3	2	3		
	EN-02	Heat Recovery Potential	Heat energy replacing natural gas	1.82	4	4	4	4	4	4	4	5	4	5	4		
	EN-03	Water Reuse Potential	not applicable to this analysis	-	-	-	-	-	-	-	-	-	-	-	-		
	EN-04	Biomethane Resource Recovery	Recovery of biomethane resources	1.82	5	5	5	5	5	5	5	1	5	1	5		
	EN-05	Power (energy) usage or generation	kilowatt hours per year consumed	1.82	2	2	2	2	2	2	2	4	3	4	3	Cost also included in EC-04	
	EN-06	Transmission Reliability	risk cost of transmission failure	1.82	5	5	2	4	2	5	5	5	5	4	5		
	EN-07	Site Remediation	risk cost of site remediation	1.82	3	3	3	3	3	3	3	3	3	3	3		
	EN-08	Pollution Discharge	air emissions discharged	1.82	3	3	3	3	3	3	3	3	3	3	3		
	EN-09	Non-renewable Resource Use	Gallons of diesel consumed per year	1.82	3	3	1	2	1	3	3	3	3	2	3	Cost also included in EC-04	
	EN-10	Non-renewable Resource Generated	Biosolids production	1.82	4	5	3	3	3	5	4	1	3	1	3		
	EN-11	Flexibility for Future Resource Recovery	Additional space needed to add 100% additional resource recovery	1.82	3	3	3	3	3	3	3	4	3	5	3		
	EN-12	Terrestrial and Inter-tidal Effect	Habitat areas potentially disturbed	1.82	5	5	5	5	5	5	5	5	5	5	5		
Environmental Subtotal (100 pts max):					75	76	66	69	64	76	75	66	73	64	73		
Social	SO-01	Impact on Property Values	Lost value to present community	1.82	5	5	5	5	5	5	5	5	5	4	4		
	SO-02	Operations Traffic in Sensitive Areas	Cost of traffic inconvenience during operations	1.82	4	4	4	4	4	4	4	5	5	2	4		
	SO-03	Operations Noise in Sensitive Areas	Cost of noise inconvenience	1.82	5	5	5	5	5	5	5	5	5	4	4		
	SO-04	Odour Potential	Cost of odour issues	1.82	3	3	3	3	3	3	3	3	3	2	2		
	SO-05	Visual Impacts	Perceived value of lost view	1.82	5	5	5	5	5	5	5	5	5	4	4		
	SO-06	Construction Disruption	Cost of traffic inconvenience due to construction	1.82	3	3	3	3	3	3	3	3	3	3	3		
	SO-07	Public and Stakeholder Acceptability	Lost time due to public disapproval	1.82	3	3	4	2	2	3	4	2	2	2	2		
	SO-08	Impacts on Future Development	Loss of value of developable land adjacent to facility	1.82	3	3	3	3	3	3	3	3	3	1	1		
	SO-09	Loss of Beneficial Site Uses	Loss of park land due to facility	1.82	3	3	3	3	3	3	3	3	3	3	3		
	SO-10	Compatibility with Designated Land Use	Delay due to zoning changes	1.82	3	3	3	3	3	3	3	3	3	3	3		
	SO-11	Cultural Resource Impacts	Risk cost of a cultural site find	1.82	3	3	3	3	3	3	3	3	3	3	3		
Social Subtotal (100 pts max):					73	73	75	71	71	73	75	73	73	56	60		
TOTAL SCORE (300 pts max):					209	208	200	200	193	207	212	193	203	178	192		

1 - Economic weighting is proportional to NPV results

Triple Bottom Line Comparison

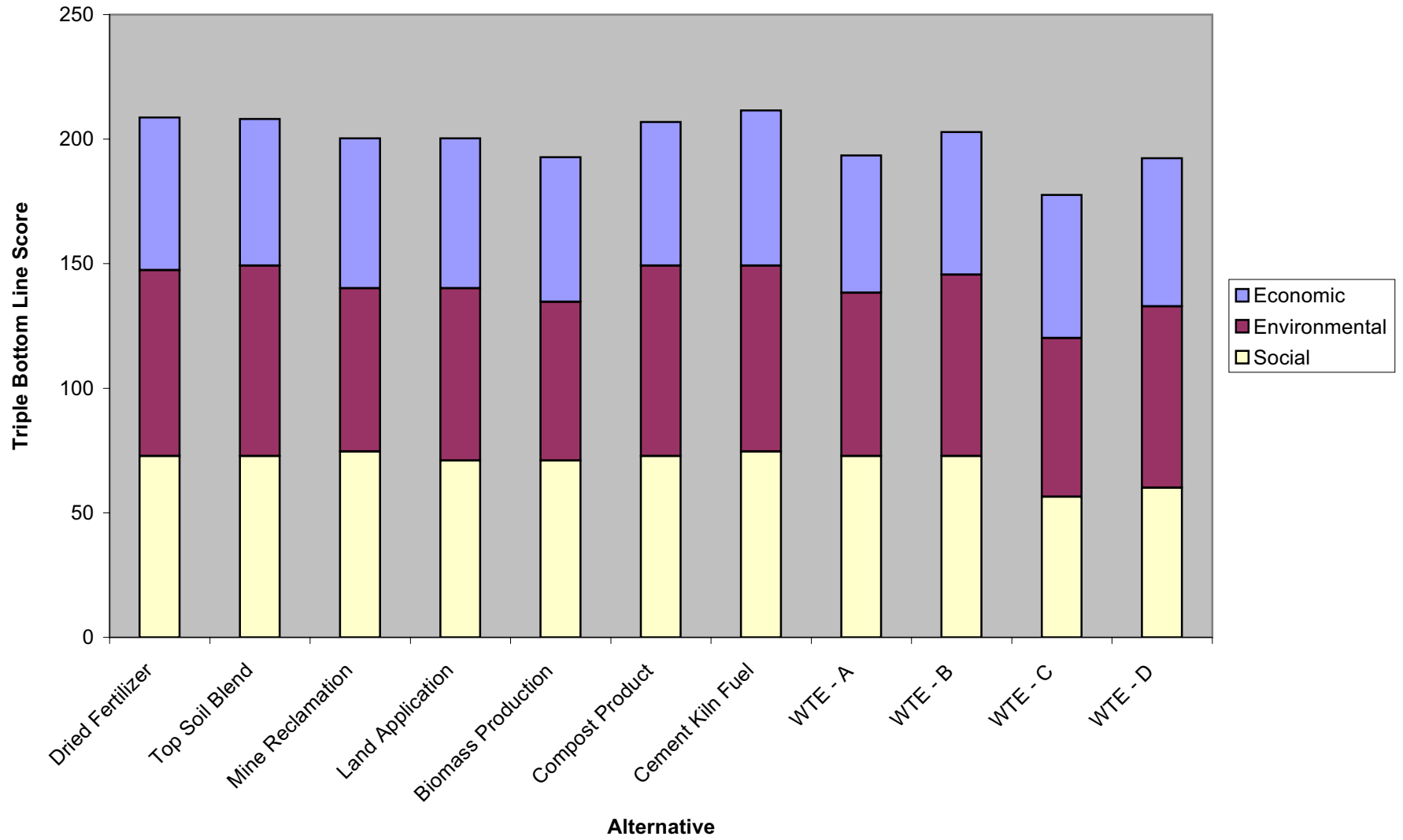

Commonly Used Assumptions:

Current Year:	2015
Baseline Year:	2065
Population growth rate:	0.38%
General Inflation:	3%
Inflation of Natural Gas:	5%
Inflation of Water Cost:	3%
Inflation of power costs:	3%
Operations Cost Inflation Rate:	3%
Discount Rate:	5%
Cost of Natural Gas:	\$10.00 per gigajoule
Cost of Water:	\$0.72 per m ³
Cost per kW-hr	\$0.08 per kW-hr
Average Home Value	\$500,000 per home
Cost of additional land	\$2,000,000
1 tonne of CO ₂ e	valued at \$25

- WTE - A On Site incineration of dried raw sludge
- WTE - B On Site incineration of dried digested sludge
- WTE - C Off site mass burn of dried raw sludge
- WTE - D Off site mass burn of dried digested sludge

EC-01 Capital Costs

construction cost and markup for soft costs adjusted to midpoint of construction

	<i>Estimated Construction Costs:</i>			
	On-Site Costs	Off-Site Costs	Total	Score
Dried Fertilizer	\$254,900,000	\$0	\$254,900,000	2.94
Top Soil Blend	\$254,900,000	\$4,870,200	\$259,770,200	2.89
Mine Reclamation	\$254,900,000	\$444,000	\$255,344,000	2.94
Land Application	\$254,900,000	\$444,000	\$255,344,000	2.94
Biomass Production	\$254,900,000	\$7,817,200	\$262,717,200	2.85
Compost Product	\$254,900,000	\$8,002,800	\$262,902,800	2.85
Cement Kiln Fuel	\$254,900,000	\$0	\$254,900,000	2.94
WTE - A	\$270,121,000	\$0	\$270,121,000	2.78
WTE - B	\$292,986,000	\$0	\$292,986,000	2.56
WTE - C	\$252,308,000	\$0	\$252,308,000	2.97
WTE - D	\$265,397,000	\$0	\$265,397,000	2.83

Scoring: All scores proportional to \$250 million as a 3

- 1
- 2
- 3 \$250 million
- 4
- 5

Notes:

Risk associated with this impact was assumed to be negligible as actual costs could be either higher or lower.



EC-02 Capital Costs Eligible for Grants

Grant fund information could not be confirmed at this time

EC-04 Present Worth of O&M and R&R Costs

Present Worth costs of annual operation and maintenance costs over 50 years (includes refurbishment and replacement costs)

Annual O&M and R&R Costs		Score	Scoring:	All scores proportional to \$250 million as a 3
Costs	NPV			
Dried Fertilizer	\$6,543,000	\$232,745,675	3.22	1
Top Soil Blend	\$7,085,200	\$252,032,654	2.98	2
Mine Reclamation	\$6,836,300	\$243,178,857	3.08	3 \$250 million
Land Application	\$6,836,300	\$243,178,857	3.08	4
Biomass Production	\$7,272,800	\$258,705,906	2.90	5
Compost Product	\$7,400,600	\$263,251,970	2.85	
Cement Kiln Fuel	\$6,543,000	\$232,745,675	3.22	
WTE - A	\$7,359,000	\$261,772,187	2.87	
WTE - B	\$7,108,000	\$252,843,689	2.97	
WTE - C	\$7,445,000	\$264,831,354	2.83	
WTE - D	\$7,074,000	\$251,634,251	2.98	

Note:

These costs include the cost of power consumption (but not revenue if power is generated).
 Other revenues from sale of gas, biosolids products, etc. are not included as well
 Risk associated with this impact was assumed to be equal with all alternatives as actual costs could be either higher or lower.
 Costs include both on-site treatment and process and off-site facility, hauling, and application costs

NPV Calculation

Year	Dried Fertilizer	Top Soil Blend	Mine Reclamation	Land Application	Biomass Production	Compost Product	Cement Kiln Fuel	WTE - A	WTE - B	WTE - C	WTE - D
2015	\$6,543,000	\$7,085,200	6836300	\$6,836,300	\$7,272,800	\$7,400,600	\$6,543,000	\$7,359,000	\$7,108,000	\$7,445,000	\$7,074,000
2016	\$6,442,761	\$6,976,655	6731568	\$6,731,568	\$7,161,381	\$7,287,223	\$6,442,761	\$7,246,260	\$6,999,105	\$7,330,943	\$6,965,626
2017	\$6,344,058	\$6,869,772	6628440	\$6,628,440	\$7,051,668	\$7,175,583	\$6,344,058	\$7,135,247	\$6,891,879	\$7,218,633	\$6,858,913
2018	\$6,246,867	\$6,764,527	6526893	\$6,526,893	\$6,943,637	\$7,065,653	\$6,246,867	\$7,025,935	\$6,786,296	\$7,108,043	\$6,753,834
2019	\$6,151,165	\$6,660,895	6426901	\$6,426,901	\$6,837,260	\$6,957,407	\$6,151,165	\$6,918,298	\$6,682,330	\$6,999,148	\$6,650,366
2020	\$6,056,929	\$6,558,850	6328440	\$6,328,440	\$6,732,513	\$6,850,819	\$6,056,929	\$6,812,310	\$6,579,956	\$6,891,921	\$6,548,482
2021	\$5,964,137	\$6,458,368	6231489	\$6,231,489	\$6,629,371	\$6,745,865	\$5,964,137	\$6,707,945	\$6,479,151	\$6,786,337	\$6,448,159
2022	\$5,872,767	\$6,359,426	6136022	\$6,136,022	\$6,527,809	\$6,642,518	\$5,872,767	\$6,605,179	\$6,379,891	\$6,682,370	\$6,349,373
2023	\$5,782,796	\$6,262,000	6042018	\$6,042,018	\$6,427,803	\$6,540,755	\$5,782,796	\$6,503,988	\$6,282,151	\$6,579,996	\$6,252,101
2024	\$5,694,203	\$6,166,066	5949455	\$5,949,455	\$6,329,329	\$6,440,550	\$5,694,203	\$6,404,347	\$6,185,908	\$6,479,191	\$6,156,319
2025	\$5,606,968	\$6,071,602	5858309	\$5,858,309	\$6,232,364	\$6,341,881	\$5,606,968	\$6,306,232	\$6,091,140	\$6,379,929	\$6,062,004
2026	\$5,521,069	\$5,978,585	5768560	\$5,768,560	\$6,136,884	\$6,244,724	\$5,521,069	\$6,209,621	\$5,997,824	\$6,282,189	\$5,969,134
2027	\$5,436,487	\$5,886,993	5680185	\$5,680,185	\$6,042,867	\$6,149,054	\$5,436,487	\$6,114,490	\$5,905,937	\$6,185,946	\$5,877,687
2028	\$5,353,200	\$5,796,804	5593165	\$5,593,165	\$5,950,290	\$6,054,851	\$5,353,200	\$6,020,816	\$5,815,458	\$6,091,777	\$5,787,641
2029	\$5,271,189	\$5,707,997	5507478	\$5,507,478	\$5,859,132	\$5,962,091	\$5,271,189	\$5,928,577	\$5,726,365	\$5,997,860	\$5,698,974
2030	\$5,190,434	\$5,620,551	5423103	\$5,423,103	\$5,769,370	\$5,870,751	\$5,190,434	\$5,837,751	\$5,638,637	\$5,905,973	\$5,611,666
2031	\$5,110,917	\$5,534,444	5340021	\$5,340,021	\$5,680,983	\$5,780,811	\$5,110,917	\$5,748,317	\$5,552,254	\$5,815,493	\$5,525,695
2032	\$5,032,617	\$5,449,656	5258212	\$5,258,212	\$5,593,951	\$5,692,249	\$5,032,617	\$5,660,252	\$5,467,193	\$5,726,400	\$5,441,042
2033	\$4,955,518	\$5,366,167	5177656	\$5,177,656	\$5,508,251	\$5,605,044	\$4,955,518	\$5,573,537	\$5,383,436	\$5,638,672	\$5,357,685
2034	\$4,879,599	\$5,283,958	5098335	\$5,098,335	\$5,423,865	\$5,519,175	\$4,879,599	\$5,488,151	\$5,300,961	\$5,552,287	\$5,275,605
2035	\$4,804,844	\$5,203,008	5020228	\$5,020,228	\$5,340,771	\$5,434,621	\$4,804,844	\$5,404,072	\$5,219,751	\$5,467,226	\$5,194,783
2036	\$4,731,233	\$5,123,297	4943318	\$4,943,318	\$5,258,951	\$5,351,363	\$4,731,233	\$5,321,282	\$5,139,784	\$5,383,468	\$5,115,199
2037	\$4,658,751	\$5,044,809	4867587	\$4,867,587	\$5,178,384	\$5,269,380	\$4,658,751	\$5,239,760	\$5,061,043	\$5,300,994	\$5,036,834
2038	\$4,587,379	\$4,967,522	4793015	\$4,793,015	\$5,099,051	\$5,188,653	\$4,587,379	\$5,158,487	\$4,983,507	\$5,219,782	\$4,959,670
2039	\$4,517,100	\$4,891,420	4719586	\$4,719,586	\$5,020,933	\$5,109,163	\$4,517,100	\$5,080,443	\$4,907,160	\$5,139,815	\$4,883,687
2040	\$4,447,898	\$4,816,483	4647282	\$4,647,282	\$4,944,013	\$5,030,890	\$4,447,898	\$5,002,611	\$4,831,982	\$5,061,073	\$4,808,869
2041	\$4,379,756	\$4,742,695	4576086	\$4,576,086	\$4,868,270	\$4,953,817	\$4,379,756	\$4,925,971	\$4,757,956	\$4,983,538	\$4,735,197
2042	\$4,312,659	\$4,670,036	4505980	\$4,505,980	\$4,793,688	\$4,877,925	\$4,312,659	\$4,850,505	\$4,685,065	\$4,907,190	\$4,662,654
2043	\$4,246,589	\$4,598,492	4436949	\$4,436,949	\$4,720,249	\$4,803,195	\$4,246,589	\$4,776,195	\$4,613,289	\$4,832,012	\$4,591,222
2044	\$4,181,531	\$4,528,043	4368974	\$4,368,974	\$4,647,935	\$4,729,610	\$4,181,531	\$4,703,024	\$4,542,614	\$4,757,985	\$4,520,885
2045	\$4,117,470	\$4,458,673	4302042	\$4,302,042	\$4,576,729	\$4,657,152	\$4,117,470	\$4,630,974	\$4,473,021	\$4,685,993	\$4,451,625
2046	\$4,054,390	\$4,390,366	4236134	\$4,236,134	\$4,506,613	\$4,585,805	\$4,054,390	\$4,560,027	\$4,404,494	\$4,613,317	\$4,383,426
2047	\$3,992,277	\$4,323,106	4171237	\$4,171,237	\$4,437,572	\$4,515,550	\$3,992,277	\$4,490,168	\$4,337,017	\$4,542,641	\$4,316,272
2048	\$3,931,115	\$4,256,876	4107334	\$4,107,334	\$4,369,588	\$4,446,372	\$3,931,115	\$4,421,378	\$4,270,574	\$4,473,048	\$4,250,147
2049	\$3,870,891	\$4,191,660	4044409	\$4,044,409	\$4,302,646	\$4,378,254	\$3,870,891	\$4,353,643	\$4,205,149	\$4,404,521	\$4,185,034
2050	\$3,811,589	\$4,127,444	3982449	\$3,982,449	\$4,236,730	\$4,311,179	\$3,811,589	\$4,286,945	\$4,140,726	\$4,337,044	\$4,120,920
2051	\$3,753,195	\$4,064,212	3921438	\$3,921,438	\$4,171,823	\$4,245,131	\$3,753,195	\$4,221,269	\$4,077,290	\$4,270,600	\$4,057,787
2052	\$3,695,696	\$4,001,948	3861361	\$3,861,361	\$4,107,911	\$4,180,096	\$3,695,696	\$4,156,599	\$4,014,826	\$4,205,175	\$3,995,622
2053	\$3,639,078	\$3,940,638	3802205	\$3,802,205	\$4,044,977	\$4,116,057	\$3,639,078	\$4,092,920	\$3,953,319	\$4,140,751	\$3,934,409
2054	\$3,583,327	\$3,880,268	3743955	\$3,743,955	\$3,983,008	\$4,052,999	\$3,583,327	\$4,030,216	\$3,892,754	\$4,077,315	\$3,874,134
2055	\$3,528,431	\$3,820,822	3686998	\$3,686,998	\$3,921,989	\$3,990,907	\$3,528,431	\$3,968,473	\$3,833,117	\$4,014,851	\$3,814,782
2056	\$3,474,375	\$3,762,287	3630119	\$3,630,119	\$3,861,904	\$3,929,766	\$3,474,375	\$3,907,676	\$3,774,394	\$3,953,343	\$3,756,340
2057	\$3,421,148	\$3,704,649	3574506	\$3,574,506	\$3,802,739	\$3,869,562	\$3,421,148	\$3,847,811	\$3,716,570	\$3,892,778	\$3,698,793
2058	\$3,368,736	\$3,647,893	3519745	\$3,519,745	\$3,744,481	\$3,810,281	\$3,368,736	\$3,788,862	\$3,659,632	\$3,833,140	\$3,642,127
2059	\$3,317,127	\$3,592,008	3465822	\$3,465,822	\$3,687,116	\$3,751,907	\$3,317,127	\$3,730,817	\$3,603,567	\$3,774,417	\$3,586,330
2060	\$3,266,308	\$3,536,978	3412726	\$3,412,726	\$3,630,629	\$3,694,428	\$3,266,308	\$3,673,661	\$3,548,360	\$3,716,593	\$3,531,387
2061	\$3,216,269	\$3,482,792	3360443	\$3,360,443	\$3,575,008	\$3,637,829	\$3,216,269	\$3,617,380	\$3,493,999	\$3,659,654	\$3,477,286
2062	\$3,166,995	\$3,429,435	3308961	\$3,308,961	\$3,520,239	\$3,582,098	\$3,166,995	\$3,561,962	\$3,440,471	\$3,603,589	\$3,424,014
2063	\$3,118,477	\$3,376,896	3258267	\$3,258,267	\$3,466,309	\$3,527,220	\$3,118,477	\$3,507,393	\$3,387,763	\$3,548,382	\$3,371,558
2064	\$3,070,702	\$3,325,162	3208351	\$3,208,351	\$3,413,205	\$3,473,183	\$3,070,702	\$3,453,660	\$3,335,863	\$3,494,020	\$3,319,906
2065	\$3,023,659	\$3,274,221	\$3,159,199	\$3,159,199	\$3,360,915	\$3,419,974	\$3,023,659	\$3,400,750	\$3,284,757	\$3,440,492	\$3,269,045
TOTAL:	\$232,745,675	\$252,032,654	\$243,178,857	\$243,178,857	\$258,705,906	\$263,251,970	\$232,745,675	\$261,772,187	\$252,843,689	\$264,831,354	\$251,634,251

EC-05 Flexibility for Future Treatment Process Optimization

cost of additional tankage needed for process optimization

	<i>Process Optimization</i>			Score
	Structural Costs	Optimization Factor	Optimization Cost	
Dried Fertilizer	\$38,400,000	0.4	\$15,360,000	3
Top Soil Blend	\$38,400,000	0.4	\$15,360,000	3
Mine Reclamation	\$38,400,000	0.4	\$15,360,000	3
Land Application	\$38,400,000	0.4	\$15,360,000	3
Biomass Production	\$38,400,000	0.4	\$15,360,000	3
Compost Product	\$38,400,000	0.4	\$15,360,000	3
Cement Kiln Fuel	\$38,400,000	0.4	\$15,360,000	3
WTE - A	\$40,693,003	1.0	\$40,693,003	1
WTE - B	\$44,137,554	0.4	\$17,655,021	3
WTE - C	\$38,009,522	1.0	\$38,009,522	1
WTE - D	\$39,981,345	0.4	\$15,992,538	3

Calculation:

Optimization Cost = Structural Cost x Optimization Factor

Scoring:

- 1 More than \$35 million
- 2 \$25 to \$35 million
- 3 \$15 to \$25 million
- 4 \$5 to \$15 million
- 5 Less than \$5 million

Notes:

Lower process optimization factor means process is easier to optimize

WTE Structural costs are same proportion of construction cost as that for other alternatives

This impact represents the risk cost of future technology resulting in a need for process optimization.

EC-06 Expandability for Population Increases

Cost of additional space needed to expand 100% from existing design loads

	<u>Process Expandability</u>		Cost to Expand	Score
	Used Site Area	Expansion Coefficient		
Dried Fertilizer	1.80	1.0	\$3,600,000	3
Top Soil Blend	1.80	1.0	\$3,600,000	3
Mine Reclamation	1.80	1.5	\$5,400,000	2
Land Application	1.80	1.5	\$5,400,000	2
Biomass Production	1.80	1.5	\$5,400,000	2
Compost Product	1.80	1.0	\$3,600,000	3
Cement Kiln Fuel	1.80	1.0	\$3,600,000	3
WTE - A	1.30	1.0	\$1,600,000	4
WTE - B	1.80	1.0	\$3,600,000	3
WTE - C	1.00	1.0	\$400,000	5
WTE - D	1.80	1.0	\$3,600,000	3

Calculation:

Cost to Expand = Site Area x (1 - Process Expansion Coefficient) x Cost of Additional Space

Scoring:

- 1 More than \$7 million
- 2 \$5 to \$7 million
- 3 \$3 to \$5 million
- 4 \$1 to \$3 million
- 5 Less than \$1 million

Assumptions: Value Reference/Basis

Cost of additional space: \$2,000,000 Per Hectare

Notes:

Process expansion coefficient is factor for additional space needed to double capacity.

Process for each option is identified in general assumptions tab

Options with digestion assumed to use 100% of site area and without digestion assumed to use 55%.

Land application, biomass production, and mine reclamation are space limited in terms of land/mine to apply to.

This impact represents the risk cost of future growth requiring an expansion.

Used site area represents the processing site and not the Hartland landfill site or utilization sites.

EC-07 Flexibility to Accommodate Future Regulations

	<i>Process Flexibility</i>			Future Regulation Costs	Score
	Structural Costs	Optimization Factor	Probability of Stricter Regulations		
Dried Fertilizer	\$38,400,000	0.4	25%	\$3,840,000	3
Top Soil Blend	\$38,400,000	0.4	25%	\$3,840,000	3
Mine Reclamation	\$38,400,000	0.4	10%	\$1,536,000	4
Land Application	\$38,400,000	0.4	10%	\$1,536,000	4
Biomass Production	\$38,400,000	0.4	10%	\$1,536,000	4
Compost Product	\$38,400,000	0.4	25%	\$3,840,000	3
Cement Kiln Fuel	\$38,400,000	0.4	15%	\$2,304,000	4
WTE - A	\$40,693,003	1.0	15%	\$6,103,950	2
WTE - B	\$44,137,554	0.4	15%	\$2,648,253	4
WTE - C	\$38,009,522	1.0	15%	\$5,701,428	2
WTE - D	\$39,981,345	0.4	15%	\$2,398,881	4

Calculation:

Future Regulation Cost = Structural Cost x Optimization Factor x Probability of Stricter Regulations

Scoring:

- 1 More than \$7 million
- 2 \$5 to \$7 million
- 3 \$3 to \$5 million
- 4 \$1 to \$3 million
- 5 Less than \$1 million

Notes:

Lower process optimization factor means more flexible

Land based options (except as noted below) are assumed to be more likely to have regulations increase than combustion options

WTE Structural costs are same proportion of construction cost as that for other alternatives

Mine reclamation, biomass production, and land application are already strictly regulated and are unlikely to have stricter regulations in the future.

This impact represents the risk cost of future regulations requiring additional treatment.

EN-01 Carbon Footprint

Value of offset carbon emissions

	GHG Credits			Score
	Equivalent Tonnes of CO2	Carbon Costs	NPV	
Dried Fertilizer	-7,427	-\$185,675	-\$6,518,972	4
Top Soil Blend	-8,580	-\$214,492	-\$7,530,739	4
Mine Reclamation	-12,125	-\$303,126	-\$10,642,627	5
Land Application	-8,370	-\$209,244	-\$7,346,470	4
Biomass Production	-8,136	-\$203,402	-\$7,141,366	4
Compost Product	-8,571	-\$214,266	-\$7,522,795	4
Cement Kiln Fuel	-9,324	-\$233,094	-\$8,183,844	4
WTE - A	1,471	\$36,771	\$1,291,017	2
WTE - B	-135	\$3,375	-\$118,495	3
WTE - C	5,065	\$126,615	\$4,445,391	2
WTE - D	-4,948	-\$123,712	-\$4,343,488	3

Assumptions: Value Reference/Basis
 Value of CO2 \$25.00 per tonne eCO2
 Inflation of CO2 value: 3%

Notes:

Risk associated with carbon footprint was assumed to be the same for each alternative.

Calculation:

See GHG chapter

Scoring:

- 1 More than \$5 million
- 2 \$0 to \$5 million
- 3 -\$5 to \$0 million
- 4 -\$10 to -\$5 million
- 5 Less than -\$10 million

NPV Calculation

Year	Dried Fertilizer	Top Soil Blend	Mine Reclamation	Land Application	Biomass Production	Compost Product	Cement Kiln Fuel	WTE - A	WTE - B	WTE - C	WTE - D
2016	-185675	-\$214,492	-\$303,126	-\$209,244	-\$203,402	-\$214,266	-\$233,094	\$36,771	-\$3,375	\$126,615	-\$123,712
2017	-182830	-\$211,206	-\$298,482	-\$206,038	-\$200,286	-\$210,984	-\$229,523	\$36,208	-\$3,323	\$124,675	-\$121,817
2018	-180029	-\$207,971	-\$293,909	-\$202,882	-\$197,218	-\$207,751	-\$226,007	\$35,653	-\$3,272	\$122,765	-\$119,951
2019	-177271	-\$204,785	-\$289,407	-\$199,774	-\$194,196	-\$204,569	-\$222,545	\$35,107	-\$3,222	\$120,884	-\$118,113
2020	-174556	-\$201,647	-\$284,973	-\$196,713	-\$191,221	-\$201,435	-\$219,135	\$34,569	-\$3,173	\$119,032	-\$116,304
2021	-171891	-\$198,558	-\$280,607	-\$193,700	-\$188,292	-\$198,349	-\$215,778	\$34,039	-\$3,124	\$117,209	-\$114,522
2022	-169248	-\$195,516	-\$276,308	-\$190,732	-\$185,407	-\$195,310	-\$212,472	\$33,518	-\$3,076	\$115,413	-\$112,767
2023	-166655	-\$192,521	-\$272,075	-\$187,810	-\$182,567	-\$192,318	-\$209,217	\$33,004	-\$3,029	\$113,645	-\$111,040
2024	-164102	-\$189,571	-\$267,907	-\$184,933	-\$179,770	-\$189,371	-\$206,012	\$32,499	-\$2,983	\$111,904	-\$109,339
2025	-161588	-\$186,667	-\$263,803	-\$182,100	-\$177,016	-\$186,470	-\$202,856	\$32,001	-\$2,937	\$110,190	-\$107,684
2026	-159113	-\$183,807	-\$259,761	-\$179,310	-\$174,304	-\$183,614	-\$199,748	\$31,511	-\$2,892	\$108,501	-\$106,014
2027	-156675	-\$180,992	-\$255,782	-\$176,563	-\$171,633	-\$180,801	-\$196,688	\$31,028	-\$2,848	\$106,839	-\$104,390
2028	-154275	-\$178,219	-\$251,863	-\$173,858	-\$169,004	-\$178,031	-\$193,675	\$30,553	-\$2,804	\$105,202	-\$102,791
2029	-151911	-\$175,488	-\$248,005	-\$171,194	-\$166,415	-\$175,303	-\$190,708	\$30,085	-\$2,761	\$103,591	-\$101,216
2030	-149584	-\$172,800	-\$244,205	-\$168,572	-\$163,865	-\$172,618	-\$187,786	\$29,624	-\$2,719	\$102,004	-\$99,665
2031	-147292	-\$170,153	-\$240,464	-\$165,989	-\$161,355	-\$169,973	-\$184,909	\$29,170	-\$2,677	\$100,441	-\$98,139
2032	-145036	-\$167,546	-\$236,780	-\$163,446	-\$158,883	-\$167,369	-\$182,076	\$28,723	-\$2,636	\$98,902	-\$96,635
2033	-142814	-\$164,979	-\$233,153	-\$160,942	-\$156,449	-\$164,805	-\$179,287	\$28,283	-\$2,596	\$97,387	-\$95,155
2034	-140626	-\$162,452	-\$229,581	-\$158,477	-\$154,052	-\$162,280	-\$176,540	\$27,850	-\$2,556	\$95,895	-\$93,697
2035	-138472	-\$159,963	-\$226,063	-\$156,049	-\$151,692	-\$159,794	-\$173,836	\$27,423	-\$2,517	\$94,426	-\$92,261
2036	-136350	-\$157,512	-\$222,600	-\$153,658	-\$149,368	-\$157,346	-\$171,172	\$27,003	-\$2,478	\$92,979	-\$90,848
2037	-134261	-\$155,099	-\$219,190	-\$151,304	-\$147,080	-\$154,936	-\$168,550	\$26,589	-\$2,440	\$91,555	-\$89,456
2038	-132204	-\$152,723	-\$215,832	-\$148,986	-\$144,827	-\$152,562	-\$165,968	\$26,182	-\$2,403	\$90,152	-\$88,086
2039	-130179	-\$150,383	-\$212,525	-\$146,704	-\$142,608	-\$150,225	-\$163,425	\$25,781	-\$2,366	\$88,771	-\$86,736
2040	-128185	-\$148,079	-\$209,269	-\$144,456	-\$140,423	-\$147,923	-\$160,922	\$25,386	-\$2,330	\$87,411	-\$85,407
2041	-126221	-\$145,811	-\$206,063	-\$142,243	-\$138,272	-\$145,657	-\$158,456	\$24,997	-\$2,294	\$86,072	-\$84,099
2042	-124287	-\$143,577	-\$202,907	-\$140,064	-\$136,153	-\$143,426	-\$156,029	\$24,614	-\$2,259	\$84,753	-\$82,811
2043	-122383	-\$141,377	-\$199,798	-\$137,918	-\$134,068	-\$141,228	-\$153,638	\$24,237	-\$2,225	\$83,455	-\$81,542
2044	-120508	-\$139,212	-\$196,737	-\$135,805	-\$132,014	-\$139,065	-\$151,285	\$23,865	-\$2,190	\$82,176	-\$80,293
2045	-118662	-\$137,079	-\$193,723	-\$133,725	-\$129,991	-\$136,934	-\$148,967	\$23,500	-\$2,157	\$80,918	-\$79,063
2046	-116844	-\$134,979	-\$190,755	-\$131,676	-\$128,000	-\$134,836	-\$146,685	\$23,140	-\$2,124	\$79,678	-\$77,851
2047	-115054	-\$132,911	-\$187,833	-\$129,659	-\$126,039	-\$132,771	-\$144,438	\$22,785	-\$2,091	\$78,457	-\$76,659
2048	-113291	-\$130,875	-\$184,955	-\$127,672	-\$124,108	-\$130,737	-\$142,225	\$22,436	-\$2,059	\$77,255	-\$75,484
2049	-111556	-\$128,870	-\$182,122	-\$125,716	-\$122,207	-\$128,734	-\$140,046	\$22,093	-\$2,028	\$76,072	-\$74,328
2050	-109847	-\$126,895	-\$179,332	-\$123,790	-\$120,334	-\$126,762	-\$137,900	\$21,754	-\$1,997	\$74,906	-\$73,189
2051	-108164	-\$124,951	-\$176,584	-\$121,894	-\$118,491	-\$124,820	-\$135,788	\$21,421	-\$1,966	\$73,759	-\$72,068
2052	-106507	-\$123,037	-\$173,879	-\$120,027	-\$116,676	-\$122,907	-\$133,708	\$21,093	-\$1,936	\$72,629	-\$70,964
2053	-104875	-\$121,152	-\$171,215	-\$118,188	-\$114,888	-\$121,024	-\$131,659	\$20,769	-\$1,906	\$71,516	-\$69,877
2054	-103269	-\$119,296	-\$168,592	-\$116,377	-\$113,128	-\$119,170	-\$129,642	\$20,451	-\$1,877	\$70,420	-\$68,806
2055	-101686	-\$117,469	-\$166,009	-\$114,594	-\$111,395	-\$117,345	-\$127,656	\$20,138	-\$1,848	\$69,342	-\$67,752
2056	-100129	-\$115,669	-\$163,466	-\$112,839	-\$109,688	-\$115,547	-\$125,700	\$19,829	-\$1,820	\$68,279	-\$66,714
2057	-98595	-\$113,897	-\$160,962	-\$111,110	-\$108,008	-\$113,777	-\$123,775	\$19,526	-\$1,792	\$67,233	-\$65,692
2058	-97084	-\$112,152	-\$158,496	-\$109,408	-\$106,353	-\$112,034	-\$121,878	\$19,227	-\$1,765	\$66,203	-\$64,686
2059	-95597	-\$110,434	-\$156,068	-\$107,732	-\$104,724	-\$110,317	-\$120,011	\$18,932	-\$1,738	\$65,189	-\$63,695
2060	-94132	-\$108,742	-\$153,677	-\$106,081	-\$103,119	-\$108,627	-\$118,173	\$18,642	-\$1,711	\$64,190	-\$62,719
2061	-92690	-\$107,076	-\$151,322	-\$104,456	-\$101,540	-\$106,963	-\$116,362	\$18,356	-\$1,685	\$63,207	-\$61,758
2062	-91270	-\$105,436	-\$149,004	-\$102,856	-\$99,984	-\$105,324	-\$114,580	\$18,075	-\$1,659	\$62,239	-\$60,812
2063	-89872	-\$103,820	-\$146,721	-\$101,280	-\$98,452	-\$103,711	-\$112,824	\$17,798	-\$1,634	\$61,285	-\$59,880
2064	-88495	-\$102,230	-\$144,474	-\$99,728	-\$96,944	-\$102,122	-\$111,096	\$17,526	-\$1,609	\$60,346	-\$58,963
2065	-87139	-\$100,664	-\$142,260	-\$98,201	-\$95,459	-\$100,557	-\$109,394	\$17,257	-\$1,584	\$59,422	-\$58,060
SUM:	-\$6,518,972	-\$7,530,739	-\$10,642,627	-\$7,346,470	-\$7,141,366	-\$7,522,795	-\$8,183,844	\$1,291,017	-\$118,495	\$4,445,391	-\$4,343,488

EN-02 Heat Recovery Potential

Heat energy used to replace natural gas use

	Heat Recovery			Score
	Projected Heat Reused	Value of Heat	NPV	
Dried Fertilizer	114,066	\$1,140,660	\$62,680,540	4
Top Soil Blend	114,066	\$1,140,660	\$62,680,540	4
Mine Reclamation	114,066	\$1,140,660	\$62,680,540	4
Land Application	114,066	\$1,140,660	\$62,680,540	4
Biomass Production	114,066	\$1,140,660	\$62,680,540	4
Compost Product	114,066	\$1,140,660	\$62,680,540	4
Cement Kiln Fuel	114,066	\$1,140,660	\$62,680,540	4
WTE - A	155,305	\$1,553,050	\$85,341,830	5
WTE - B	114,066	\$1,140,660	\$62,680,540	4
WTE - C	155,305	\$1,553,050	\$85,341,830	5
WTE - D	114,066	\$1,140,660	\$62,680,540	4

Assumptions: Value Reference/Basis
 Cost of Natural Gas: \$10.00 per gigajoule
 Inflation of Natural Gas: 5%

Notes:

This calculation is gross value of recovered heat, not revenue.
 More heat intensive processes were considered more valuable because they beneficially use more heat instead of wasting it.
 Does not include heat recovery for district heating at WTE facilities located in inner harbour site
 Raw solids options require 2x the heat required for drying by no heat required for digestion.
 Risk associated with this impact was assumed to be negligible. Actual heat recovery could be either higher or lower than what is reported here.

Calculation:

Value of Heat = Projected Heat Reused x
 Cost of Natural Gas

Scoring:

- 1 Less than \$10 million
- 2 \$10 to \$40 million
- 3 \$40 to \$60 million
- 4 \$60 to \$80 million
- 5 More than \$80 million

NPV Calculation

Year	Dried Fertilizer	Top Soil Blend	Mine Reclamation	Land Application	Biomass Production	Compost Product	Cement Kiln Fuel	WTE - A	WTE - B	WTE - C	WTE - D
2016	1140660	\$1,140,660	\$1,140,660	\$1,140,660	\$1,140,660	\$1,140,660	\$1,140,660	\$1,553,050	\$1,140,660	\$1,553,050	\$1,140,660
2017	1144995	\$1,144,995	\$1,144,995	\$1,144,995	\$1,144,995	\$1,144,995	\$1,144,995	\$1,558,952	\$1,144,995	\$1,558,952	\$1,144,995
2018	1149345	\$1,149,345	\$1,149,345	\$1,149,345	\$1,149,345	\$1,149,345	\$1,149,345	\$1,564,876	\$1,149,345	\$1,564,876	\$1,149,345
2019	1153713	\$1,153,713	\$1,153,713	\$1,153,713	\$1,153,713	\$1,153,713	\$1,153,713	\$1,570,822	\$1,153,713	\$1,570,822	\$1,153,713
2020	1158097	\$1,158,097	\$1,158,097	\$1,158,097	\$1,158,097	\$1,158,097	\$1,158,097	\$1,576,791	\$1,158,097	\$1,576,791	\$1,158,097
2021	1162498	\$1,162,498	\$1,162,498	\$1,162,498	\$1,162,498	\$1,162,498	\$1,162,498	\$1,582,783	\$1,162,498	\$1,582,783	\$1,162,498
2022	1166915	\$1,166,915	\$1,166,915	\$1,166,915	\$1,166,915	\$1,166,915	\$1,166,915	\$1,588,798	\$1,166,915	\$1,588,798	\$1,166,915
2023	1171350	\$1,171,350	\$1,171,350	\$1,171,350	\$1,171,350	\$1,171,350	\$1,171,350	\$1,594,835	\$1,171,350	\$1,594,835	\$1,171,350
2024	1175801	\$1,175,801	\$1,175,801	\$1,175,801	\$1,175,801	\$1,175,801	\$1,175,801	\$1,600,895	\$1,175,801	\$1,600,895	\$1,175,801
2025	1180269	\$1,180,269	\$1,180,269	\$1,180,269	\$1,180,269	\$1,180,269	\$1,180,269	\$1,606,979	\$1,180,269	\$1,606,979	\$1,180,269
2026	1184754	\$1,184,754	\$1,184,754	\$1,184,754	\$1,184,754	\$1,184,754	\$1,184,754	\$1,613,085	\$1,184,754	\$1,613,085	\$1,184,754
2027	1189256	\$1,189,256	\$1,189,256	\$1,189,256	\$1,189,256	\$1,189,256	\$1,189,256	\$1,619,215	\$1,189,256	\$1,619,215	\$1,189,256
2028	1193775	\$1,193,775	\$1,193,775	\$1,193,775	\$1,193,775	\$1,193,775	\$1,193,775	\$1,625,368	\$1,193,775	\$1,625,368	\$1,193,775
2029	1198311	\$1,198,311	\$1,198,311	\$1,198,311	\$1,198,311	\$1,198,311	\$1,198,311	\$1,631,545	\$1,198,311	\$1,631,545	\$1,198,311
2030	1202865	\$1,202,865	\$1,202,865	\$1,202,865	\$1,202,865	\$1,202,865	\$1,202,865	\$1,637,744	\$1,202,865	\$1,637,744	\$1,202,865
2031	1207436	\$1,207,436	\$1,207,436	\$1,207,436	\$1,207,436	\$1,207,436	\$1,207,436	\$1,643,968	\$1,207,436	\$1,643,968	\$1,207,436
2032	1212024	\$1,212,024	\$1,212,024	\$1,212,024	\$1,212,024	\$1,212,024	\$1,212,024	\$1,650,215	\$1,212,024	\$1,650,215	\$1,212,024
2033	1216630	\$1,216,630	\$1,216,630	\$1,216,630	\$1,216,630	\$1,216,630	\$1,216,630	\$1,656,486	\$1,216,630	\$1,656,486	\$1,216,630
2034	1221253	\$1,221,253	\$1,221,253	\$1,221,253	\$1,221,253	\$1,221,253	\$1,221,253	\$1,662,780	\$1,221,253	\$1,662,780	\$1,221,253
2035	1225894	\$1,225,894	\$1,225,894	\$1,225,894	\$1,225,894	\$1,225,894	\$1,225,894	\$1,669,099	\$1,225,894	\$1,669,099	\$1,225,894
2036	1230552	\$1,230,552	\$1,230,552	\$1,230,552	\$1,230,552	\$1,230,552	\$1,230,552	\$1,675,441	\$1,230,552	\$1,675,441	\$1,230,552
2037	1235228	\$1,235,228	\$1,235,228	\$1,235,228	\$1,235,228	\$1,235,228	\$1,235,228	\$1,681,808	\$1,235,228	\$1,681,808	\$1,235,228
2038	1239922	\$1,239,922	\$1,239,922	\$1,239,922	\$1,239,922	\$1,239,922	\$1,239,922	\$1,688,199	\$1,239,922	\$1,688,199	\$1,239,922
2039	1244634	\$1,244,634	\$1,244,634	\$1,244,634	\$1,244,634	\$1,244,634	\$1,244,634	\$1,694,614	\$1,244,634	\$1,694,614	\$1,244,634
2040	1249363	\$1,249,363	\$1,249,363	\$1,249,363	\$1,249,363	\$1,249,363	\$1,249,363	\$1,701,054	\$1,249,363	\$1,701,054	\$1,249,363
2041	1254111	\$1,254,111	\$1,254,111	\$1,254,111	\$1,254,111	\$1,254,111	\$1,254,111	\$1,707,518	\$1,254,111	\$1,707,518	\$1,254,111
2042	1258877	\$1,258,877	\$1,258,877	\$1,258,877	\$1,258,877	\$1,258,877	\$1,258,877	\$1,714,006	\$1,258,877	\$1,714,006	\$1,258,877
2043	1263660	\$1,263,660	\$1,263,660	\$1,263,660	\$1,263,660	\$1,263,660	\$1,263,660	\$1,720,520	\$1,263,660	\$1,720,520	\$1,263,660
2044	1268462	\$1,268,462	\$1,268,462	\$1,268,462	\$1,268,462	\$1,268,462	\$1,268,462	\$1,727,057	\$1,268,462	\$1,727,057	\$1,268,462
2045	1273282	\$1,273,282	\$1,273,282	\$1,273,282	\$1,273,282	\$1,273,282	\$1,273,282	\$1,733,620	\$1,273,282	\$1,733,620	\$1,273,282
2046	1278121	\$1,278,121	\$1,278,121	\$1,278,121	\$1,278,121	\$1,278,121	\$1,278,121	\$1,740,208	\$1,278,121	\$1,740,208	\$1,278,121
2047	1282978	\$1,282,978	\$1,282,978	\$1,282,978	\$1,282,978	\$1,282,978	\$1,282,978	\$1,746,821	\$1,282,978	\$1,746,821	\$1,282,978
2048	1287853	\$1,287,853	\$1,287,853	\$1,287,853	\$1,287,853	\$1,287,853	\$1,287,853	\$1,753,459	\$1,287,853	\$1,753,459	\$1,287,853
2049	1292747	\$1,292,747	\$1,292,747	\$1,292,747	\$1,292,747	\$1,292,747	\$1,292,747	\$1,760,122	\$1,292,747	\$1,760,122	\$1,292,747
2050	1297659	\$1,297,659	\$1,297,659	\$1,297,659	\$1,297,659	\$1,297,659	\$1,297,659	\$1,766,810	\$1,297,659	\$1,766,810	\$1,297,659
2051	1302591	\$1,302,591	\$1,302,591	\$1,302,591	\$1,302,591	\$1,302,591	\$1,302,591	\$1,773,524	\$1,302,591	\$1,773,524	\$1,302,591
2052	1307540	\$1,307,540	\$1,307,540	\$1,307,540	\$1,307,540	\$1,307,540	\$1,307,540	\$1,780,264	\$1,307,540	\$1,780,264	\$1,307,540
2053	1312509	\$1,312,509	\$1,312,509	\$1,312,509	\$1,312,509	\$1,312,509	\$1,312,509	\$1,787,029	\$1,312,509	\$1,787,029	\$1,312,509
2054	1317497	\$1,317,497	\$1,317,497	\$1,317,497	\$1,317,497	\$1,317,497	\$1,317,497	\$1,793,819	\$1,317,497	\$1,793,819	\$1,317,497
2055	1322503	\$1,322,503	\$1,322,503	\$1,322,503	\$1,322,503	\$1,322,503	\$1,322,503	\$1,800,636	\$1,322,503	\$1,800,636	\$1,322,503
2056	1327529	\$1,327,529	\$1,327,529	\$1,327,529	\$1,327,529	\$1,327,529	\$1,327,529	\$1,807,478	\$1,327,529	\$1,807,478	\$1,327,529
2057	1332573	\$1,332,573	\$1,332,573	\$1,332,573	\$1,332,573	\$1,332,573	\$1,332,573	\$1,814,347	\$1,332,573	\$1,814,347	\$1,332,573
2058	1337637	\$1,337,637	\$1,337,637	\$1,337,637	\$1,337,637	\$1,337,637	\$1,337,637	\$1,821,241	\$1,337,637	\$1,821,241	\$1,337,637
2059	1342720	\$1,342,720	\$1,342,720	\$1,342,720	\$1,342,720	\$1,342,720	\$1,342,720	\$1,828,162	\$1,342,720	\$1,828,162	\$1,342,720
2060	1347822	\$1,347,822	\$1,347,822	\$1,347,822	\$1,347,822	\$1,347,822	\$1,347,822	\$1,835,109	\$1,347,822	\$1,835,109	\$1,347,822
2061	1352944	\$1,352,944	\$1,352,944	\$1,352,944	\$1,352,944	\$1,352,944	\$1,352,944	\$1,842,082	\$1,352,944	\$1,842,082	\$1,352,944
2062	1358085	\$1,358,085	\$1,358,085	\$1,358,085	\$1,358,085	\$1,358,085	\$1,358,085	\$1,849,082	\$1,358,085	\$1,849,082	\$1,358,085
2063	1363246	\$1,363,246	\$1,363,246	\$1,363,246	\$1,363,246	\$1,363,246	\$1,363,246	\$1,856,109	\$1,363,246	\$1,856,109	\$1,363,246
2064	1368426	\$1,368,426	\$1,368,426	\$1,368,426	\$1,368,426	\$1,368,426	\$1,368,426	\$1,863,162	\$1,368,426	\$1,863,162	\$1,368,426
2065	1373626	\$1,373,626	\$1,373,626	\$1,373,626	\$1,373,626	\$1,373,626	\$1,373,626	\$1,870,242	\$1,373,626	\$1,870,242	\$1,373,626
SUM:	\$62,680,540	\$62,680,540	\$62,680,540	\$62,680,540	\$62,680,540	\$62,680,540	\$62,680,540	\$85,341,830	\$62,680,540	\$85,341,830	\$62,680,540



EN-03 Water Reuse Potential

Not applicable to this analysis

EN-04 Biomethane Resource Recovery

Recovery of biomethane resources

Biomethane Recovered	Biomethane Resource Recovery			NPV	Score
	Biomethane Recovered	Codigestion Substrate	Value of Recovery		
Dried Fertilizer	136,500	25.2	\$2,247,000	\$126,191,363	5
Top Soil Blend	136,500	25.2	\$2,247,000	\$126,191,363	5
Mine Reclamation	136,500	25.2	\$2,247,000	\$126,191,363	5
Land Application	136,500	25.2	\$2,247,000	\$126,191,363	5
Biomass Production	136,500	25.2	\$2,247,000	\$126,191,363	5
Compost Product	136,500	25.2	\$2,247,000	\$126,191,363	5
Cement Kiln Fuel	136,500	25.2	\$2,247,000	\$126,191,363	5
WTE - A	0	0	\$0	\$0	1
WTE - B	129,675	25.2	\$2,178,750	\$122,358,447	5
WTE - C	0	0	\$0	\$0	1
WTE - D	129,675	25.2	\$2,178,750	\$122,358,447	5

Assumptions:

Value	Reference/Basis
Cost of Natural Gas:	\$10.00 per gigajoule
Inflation of Natural Gas:	5%
Tipping fee:	\$0.035 per liter of FOG

Notes:

Risk associated with this impact was assumed to be negligible. Actual revenues could be either higher or lower than those reported here.

Calculation:

Value of Biomethane = kJ recovered x cost of natural gas + tipping fees

Scoring:

- 1 Less than \$10 million
- 2 \$10 to \$40 million
- 3 \$40 to \$70 million
- 4 \$ 70 to \$100 million
- 5 More than \$100 million

NPV Calculation

Year	Dried Fertilizer	Top Soil Blend	Mine Reclamation	Land Application	Biomass Production	Compost Product	Cement Kiln Fuel	WTE - A	WTE - B	WTE - C	WTE - D
2015	\$2,247,000	\$2,247,000	\$2,247,000	\$2,247,000	\$2,247,000	\$2,247,000	\$2,247,000	\$0	\$2,178,750	\$0	\$2,178,750
2016	\$2,255,539	\$2,255,539	\$2,255,539	\$2,255,539	\$2,255,539	\$2,255,539	\$2,255,539	\$0	\$2,187,029	\$0	\$2,187,029
2017	\$2,264,110	\$2,264,110	\$2,264,110	\$2,264,110	\$2,264,110	\$2,264,110	\$2,264,110	\$0	\$2,195,340	\$0	\$2,195,340
2018	\$2,272,713	\$2,272,713	\$2,272,713	\$2,272,713	\$2,272,713	\$2,272,713	\$2,272,713	\$0	\$2,203,682	\$0	\$2,203,682
2019	\$2,281,350	\$2,281,350	\$2,281,350	\$2,281,350	\$2,281,350	\$2,281,350	\$2,281,350	\$0	\$2,212,056	\$0	\$2,212,056
2020	\$2,290,019	\$2,290,019	\$2,290,019	\$2,290,019	\$2,290,019	\$2,290,019	\$2,290,019	\$0	\$2,220,462	\$0	\$2,220,462
2021	\$2,298,721	\$2,298,721	\$2,298,721	\$2,298,721	\$2,298,721	\$2,298,721	\$2,298,721	\$0	\$2,228,900	\$0	\$2,228,900
2022	\$2,307,456	\$2,307,456	\$2,307,456	\$2,307,456	\$2,307,456	\$2,307,456	\$2,307,456	\$0	\$2,237,370	\$0	\$2,237,370
2023	\$2,316,224	\$2,316,224	\$2,316,224	\$2,316,224	\$2,316,224	\$2,316,224	\$2,316,224	\$0	\$2,245,872	\$0	\$2,245,872
2024	\$2,325,026	\$2,325,026	\$2,325,026	\$2,325,026	\$2,325,026	\$2,325,026	\$2,325,026	\$0	\$2,254,406	\$0	\$2,254,406
2025	\$2,333,861	\$2,333,861	\$2,333,861	\$2,333,861	\$2,333,861	\$2,333,861	\$2,333,861	\$0	\$2,262,973	\$0	\$2,262,973
2026	\$2,342,730	\$2,342,730	\$2,342,730	\$2,342,730	\$2,342,730	\$2,342,730	\$2,342,730	\$0	\$2,271,572	\$0	\$2,271,572
2027	\$2,351,632	\$2,351,632	\$2,351,632	\$2,351,632	\$2,351,632	\$2,351,632	\$2,351,632	\$0	\$2,280,204	\$0	\$2,280,204
2028	\$2,360,568	\$2,360,568	\$2,360,568	\$2,360,568	\$2,360,568	\$2,360,568	\$2,360,568	\$0	\$2,288,869	\$0	\$2,288,869
2029	\$2,369,538	\$2,369,538	\$2,369,538	\$2,369,538	\$2,369,538	\$2,369,538	\$2,369,538	\$0	\$2,297,566	\$0	\$2,297,566
2030	\$2,378,543	\$2,378,543	\$2,378,543	\$2,378,543	\$2,378,543	\$2,378,543	\$2,378,543	\$0	\$2,306,297	\$0	\$2,306,297
2031	\$2,387,581	\$2,387,581	\$2,387,581	\$2,387,581	\$2,387,581	\$2,387,581	\$2,387,581	\$0	\$2,315,061	\$0	\$2,315,061
2032	\$2,396,654	\$2,396,654	\$2,396,654	\$2,396,654	\$2,396,654	\$2,396,654	\$2,396,654	\$0	\$2,323,858	\$0	\$2,323,858
2033	\$2,405,761	\$2,405,761	\$2,405,761	\$2,405,761	\$2,405,761	\$2,405,761	\$2,405,761	\$0	\$2,332,689	\$0	\$2,332,689
2034	\$2,414,903	\$2,414,903	\$2,414,903	\$2,414,903	\$2,414,903	\$2,414,903	\$2,414,903	\$0	\$2,341,553	\$0	\$2,341,553
2035	\$2,424,080	\$2,424,080	\$2,424,080	\$2,424,080	\$2,424,080	\$2,424,080	\$2,424,080	\$0	\$2,350,451	\$0	\$2,350,451
2036	\$2,433,291	\$2,433,291	\$2,433,291	\$2,433,291	\$2,433,291	\$2,433,291	\$2,433,291	\$0	\$2,359,383	\$0	\$2,359,383
2037	\$2,442,538	\$2,442,538	\$2,442,538	\$2,442,538	\$2,442,538	\$2,442,538	\$2,442,538	\$0	\$2,368,349	\$0	\$2,368,349
2038	\$2,451,819	\$2,451,819	\$2,451,819	\$2,451,819	\$2,451,819	\$2,451,819	\$2,451,819	\$0	\$2,377,348	\$0	\$2,377,348
2039	\$2,461,136	\$2,461,136	\$2,461,136	\$2,461,136	\$2,461,136	\$2,461,136	\$2,461,136	\$0	\$2,386,382	\$0	\$2,386,382
2040	\$2,470,489	\$2,470,489	\$2,470,489	\$2,470,489	\$2,470,489	\$2,470,489	\$2,470,489	\$0	\$2,395,450	\$0	\$2,395,450
2041	\$2,479,876	\$2,479,876	\$2,479,876	\$2,479,876	\$2,479,876	\$2,479,876	\$2,479,876	\$0	\$2,404,553	\$0	\$2,404,553
2042	\$2,489,300	\$2,489,300	\$2,489,300	\$2,489,300	\$2,489,300	\$2,489,300	\$2,489,300	\$0	\$2,413,690	\$0	\$2,413,690
2043	\$2,498,759	\$2,498,759	\$2,498,759	\$2,498,759	\$2,498,759	\$2,498,759	\$2,498,759	\$0	\$2,422,862	\$0	\$2,422,862
2044	\$2,508,255	\$2,508,255	\$2,508,255	\$2,508,255	\$2,508,255	\$2,508,255	\$2,508,255	\$0	\$2,432,069	\$0	\$2,432,069
2045	\$2,517,786	\$2,517,786	\$2,517,786	\$2,517,786	\$2,517,786	\$2,517,786	\$2,517,786	\$0	\$2,441,311	\$0	\$2,441,311
2046	\$2,527,354	\$2,527,354	\$2,527,354	\$2,527,354	\$2,527,354	\$2,527,354	\$2,527,354	\$0	\$2,450,588	\$0	\$2,450,588
2047	\$2,536,958	\$2,536,958	\$2,536,958	\$2,536,958	\$2,536,958	\$2,536,958	\$2,536,958	\$0	\$2,459,900	\$0	\$2,459,900
2048	\$2,546,598	\$2,546,598	\$2,546,598	\$2,546,598	\$2,546,598	\$2,546,598	\$2,546,598	\$0	\$2,469,248	\$0	\$2,469,248
2049	\$2,556,275	\$2,556,275	\$2,556,275	\$2,556,275	\$2,556,275	\$2,556,275	\$2,556,275	\$0	\$2,478,631	\$0	\$2,478,631
2050	\$2,565,989	\$2,565,989	\$2,565,989	\$2,565,989	\$2,565,989	\$2,565,989	\$2,565,989	\$0	\$2,488,050	\$0	\$2,488,050
2051	\$2,575,740	\$2,575,740	\$2,575,740	\$2,575,740	\$2,575,740	\$2,575,740	\$2,575,740	\$0	\$2,497,505	\$0	\$2,497,505
2052	\$2,585,527	\$2,585,527	\$2,585,527	\$2,585,527	\$2,585,527	\$2,585,527	\$2,585,527	\$0	\$2,506,995	\$0	\$2,506,995
2053	\$2,595,352	\$2,595,352	\$2,595,352	\$2,595,352	\$2,595,352	\$2,595,352	\$2,595,352	\$0	\$2,516,522	\$0	\$2,516,522
2054	\$2,605,215	\$2,605,215	\$2,605,215	\$2,605,215	\$2,605,215	\$2,605,215	\$2,605,215	\$0	\$2,526,084	\$0	\$2,526,084
2055	\$2,615,115	\$2,615,115	\$2,615,115	\$2,615,115	\$2,615,115	\$2,615,115	\$2,615,115	\$0	\$2,535,684	\$0	\$2,535,684
2056	\$2,625,052	\$2,625,052	\$2,625,052	\$2,625,052	\$2,625,052	\$2,625,052	\$2,625,052	\$0	\$2,545,319	\$0	\$2,545,319
2057	\$2,635,027	\$2,635,027	\$2,635,027	\$2,635,027	\$2,635,027	\$2,635,027	\$2,635,027	\$0	\$2,554,991	\$0	\$2,554,991
2058	\$2,645,040	\$2,645,040	\$2,645,040	\$2,645,040	\$2,645,040	\$2,645,040	\$2,645,040	\$0	\$2,564,700	\$0	\$2,564,700
2059	\$2,655,091	\$2,655,091	\$2,655,091	\$2,655,091	\$2,655,091	\$2,655,091	\$2,655,091	\$0	\$2,574,446	\$0	\$2,574,446
2060	\$2,665,181	\$2,665,181	\$2,665,181	\$2,665,181	\$2,665,181	\$2,665,181	\$2,665,181	\$0	\$2,584,229	\$0	\$2,584,229
2061	\$2,675,309	\$2,675,309	\$2,675,309	\$2,675,309	\$2,675,309	\$2,675,309	\$2,675,309	\$0	\$2,594,049	\$0	\$2,594,049
2062	\$2,685,475	\$2,685,475	\$2,685,475	\$2,685,475	\$2,685,475	\$2,685,475	\$2,685,475	\$0	\$2,603,907	\$0	\$2,603,907
2063	\$2,695,680	\$2,695,680	\$2,695,680	\$2,695,680	\$2,695,680	\$2,695,680	\$2,695,680	\$0	\$2,613,801	\$0	\$2,613,801
2064	\$2,705,923	\$2,705,923	\$2,705,923	\$2,705,923	\$2,705,923	\$2,705,923	\$2,705,923	\$0	\$2,623,734	\$0	\$2,623,734
2065	\$2,716,206	\$2,716,206	\$2,716,206	\$2,716,206	\$2,716,206	\$2,716,206	\$2,716,206	\$0	\$2,633,704	\$0	\$2,633,704
SUM	\$126,191,363	\$126,191,363	\$126,191,363	\$126,191,363	\$126,191,363	\$126,191,363	\$126,191,363	\$0	\$122,358,447	\$0	\$122,358,447

EN-05 Power (energy) usage

kilowatt hours per year consumed

	Power Consumption				Score	
	Power Consumed	Power Produced	Net Power Consumption	Net Cost		
Dried Fertilizer	26,709,044	0	26,709,044	\$2,136,724	\$75,019,478	2
Top Soil Blend	26,709,044	0	26,709,044	\$2,136,724	\$75,019,478	2
Mine Reclamation	26,709,044	0	26,709,044	\$2,136,724	\$75,019,478	2
Land Application	26,709,044	0	26,709,044	\$2,136,724	\$75,019,478	2
Biomass Production	26,709,044	0	26,709,044	\$2,136,724	\$75,019,478	2
Compost Product	26,709,044	0	26,709,044	\$2,136,724	\$75,019,478	2
Cement Kiln Fuel	26,709,044	0	26,709,044	\$2,136,724	\$75,019,478	2
WTE - A	11,741,274	6,421,080	5,320,194	\$425,615	\$14,943,183	4
WTE - B	20,060,204	2,557,920	17,502,284	\$1,400,183	\$49,159,836	3
WTE - C	21,589,339	14,567,150	7,022,189	\$561,775	\$19,723,690	4
WTE - D	26,751,384	6,491,708	20,259,677	\$1,620,774	\$56,904,708	3

Assumptions:	Value	Reference/Basis
Cost per kW-hr consumed:	\$0.08	per kW-hr
Inflation of power costs:	3%	

Notes:

Risk associated with this impact was assumed to be negligible. Actual consumption could be either higher or lower than those reported here.

Calculation:

Net Power Cost = Net Power Consumption x Cost of Power

Scoring:

- 1 More than \$100 million
- 2 \$70 to \$100 million
- 3 \$40 to \$70 million
- 4 \$10 to \$40 million
- 5 Less than \$10 million

NPV Calculation

Year	Dried Fertilizer	Top Soil Blend	Mine Reclamation	Land Application	Biomass Production	Compost Product	Cement Kiln Fuel	WTE - A	WTE - B	WTE - C	WTE - D
\$2,016	\$2,136,724	\$2,136,724	\$2,136,724	\$2,136,724	\$2,136,724	\$2,136,724	\$2,136,724	\$425,615	\$1,400,183	\$561,775	\$1,620,774
\$2,017	\$2,103,989	\$2,103,989	\$2,103,989	\$2,103,989	\$2,103,989	\$2,103,989	\$2,103,989	\$414,095	\$1,378,732	\$553,169	\$1,595,944
\$2,018	\$2,071,756	\$2,071,756	\$2,071,756	\$2,071,756	\$2,071,756	\$2,071,756	\$2,071,756	\$402,675	\$1,357,610	\$544,694	\$1,571,494
\$2,019	\$2,040,017	\$2,040,017	\$2,040,017	\$2,040,017	\$2,040,017	\$2,040,017	\$2,040,017	\$390,257	\$1,336,811	\$536,349	\$1,547,419
\$2,020	\$2,008,763	\$2,008,763	\$2,008,763	\$2,008,763	\$2,008,763	\$2,008,763	\$2,008,763	\$377,839	\$1,316,331	\$528,133	\$1,523,712
\$2,021	\$1,977,989	\$1,977,989	\$1,977,989	\$1,977,989	\$1,977,989	\$1,977,989	\$1,977,989	\$365,421	\$1,296,165	\$520,042	\$1,500,369
\$2,022	\$1,947,686	\$1,947,686	\$1,947,686	\$1,947,686	\$1,947,686	\$1,947,686	\$1,947,686	\$353,003	\$1,276,308	\$512,075	\$1,477,383
\$2,023	\$1,917,848	\$1,917,848	\$1,917,848	\$1,917,848	\$1,917,848	\$1,917,848	\$1,917,848	\$340,585	\$1,256,755	\$504,230	\$1,454,750
\$2,024	\$1,888,466	\$1,888,466	\$1,888,466	\$1,888,466	\$1,888,466	\$1,888,466	\$1,888,466	\$328,167	\$1,237,501	\$496,505	\$1,432,463
\$2,025	\$1,859,535	\$1,859,535	\$1,859,535	\$1,859,535	\$1,859,535	\$1,859,535	\$1,859,535	\$315,749	\$1,218,543	\$488,898	\$1,410,518
\$2,026	\$1,831,047	\$1,831,047	\$1,831,047	\$1,831,047	\$1,831,047	\$1,831,047	\$1,831,047	\$303,331	\$1,199,875	\$481,408	\$1,388,909
\$2,027	\$1,802,995	\$1,802,995	\$1,802,995	\$1,802,995	\$1,802,995	\$1,802,995	\$1,802,995	\$290,913	\$1,181,493	\$474,033	\$1,367,631
\$2,028	\$1,775,374	\$1,775,374	\$1,775,374	\$1,775,374	\$1,775,374	\$1,775,374	\$1,775,374	\$278,495	\$1,163,392	\$466,771	\$1,346,678
\$2,029	\$1,748,175	\$1,748,175	\$1,748,175	\$1,748,175	\$1,748,175	\$1,748,175	\$1,748,175	\$266,077	\$1,145,569	\$459,620	\$1,326,047
\$2,030	\$1,721,393	\$1,721,393	\$1,721,393	\$1,721,393	\$1,721,393	\$1,721,393	\$1,721,393	\$253,659	\$1,128,019	\$452,579	\$1,305,732
\$2,031	\$1,695,021	\$1,695,021	\$1,695,021	\$1,695,021	\$1,695,021	\$1,695,021	\$1,695,021	\$241,241	\$1,110,738	\$445,645	\$1,285,728
\$2,032	\$1,669,053	\$1,669,053	\$1,669,053	\$1,669,053	\$1,669,053	\$1,669,053	\$1,669,053	\$228,823	\$1,093,721	\$438,818	\$1,266,031
\$2,033	\$1,643,483	\$1,643,483	\$1,643,483	\$1,643,483	\$1,643,483	\$1,643,483	\$1,643,483	\$216,405	\$1,076,965	\$432,095	\$1,246,636
\$2,034	\$1,618,305	\$1,618,305	\$1,618,305	\$1,618,305	\$1,618,305	\$1,618,305	\$1,618,305	\$203,987	\$1,060,466	\$425,476	\$1,227,537
\$2,035	\$1,593,513	\$1,593,513	\$1,593,513	\$1,593,513	\$1,593,513	\$1,593,513	\$1,593,513	\$191,569	\$1,044,220	\$418,957	\$1,208,731
\$2,036	\$1,569,100	\$1,569,100	\$1,569,100	\$1,569,100	\$1,569,100	\$1,569,100	\$1,569,100	\$179,151	\$1,028,222	\$412,539	\$1,190,213
\$2,037	\$1,545,062	\$1,545,062	\$1,545,062	\$1,545,062	\$1,545,062	\$1,545,062	\$1,545,062	\$166,733	\$1,012,470	\$406,219	\$1,171,979
\$2,038	\$1,521,391	\$1,521,391	\$1,521,391	\$1,521,391	\$1,521,391	\$1,521,391	\$1,521,391	\$154,315	\$996,959	\$399,995	\$1,154,205
\$2,039	\$1,498,084	\$1,498,084	\$1,498,084	\$1,498,084	\$1,498,084	\$1,498,084	\$1,498,084	\$141,897	\$981,686	\$393,868	\$1,136,346
\$2,040	\$1,475,133	\$1,475,133	\$1,475,133	\$1,475,133	\$1,475,133	\$1,475,133	\$1,475,133	\$129,479	\$966,646	\$387,833	\$1,118,936
\$2,041	\$1,452,534	\$1,452,534	\$1,452,534	\$1,452,534	\$1,452,534	\$1,452,534	\$1,452,534	\$117,061	\$951,837	\$381,892	\$1,101,794
\$2,042	\$1,430,281	\$1,430,281	\$1,430,281	\$1,430,281	\$1,430,281	\$1,430,281	\$1,430,281	\$104,643	\$937,255	\$376,041	\$1,084,915
\$2,043	\$1,408,369	\$1,408,369	\$1,408,369	\$1,408,369	\$1,408,369	\$1,408,369	\$1,408,369	\$92,225	\$922,896	\$370,280	\$1,068,294
\$2,044	\$1,386,793	\$1,386,793	\$1,386,793	\$1,386,793	\$1,386,793	\$1,386,793	\$1,386,793	\$79,807	\$908,757	\$364,608	\$1,051,927
\$2,045	\$1,365,547	\$1,365,547	\$1,365,547	\$1,365,547	\$1,365,547	\$1,365,547	\$1,365,547	\$67,389	\$894,835	\$359,022	\$1,035,812
\$2,046	\$1,344,627	\$1,344,627	\$1,344,627	\$1,344,627	\$1,344,627	\$1,344,627	\$1,344,627	\$54,971	\$881,126	\$353,522	\$1,019,943
\$2,047	\$1,324,027	\$1,324,027	\$1,324,027	\$1,324,027	\$1,324,027	\$1,324,027	\$1,324,027	\$42,553	\$867,628	\$348,106	\$1,004,318
\$2,048	\$1,303,743	\$1,303,743	\$1,303,743	\$1,303,743	\$1,303,743	\$1,303,743	\$1,303,743	\$30,135	\$854,336	\$342,773	\$988,932
\$2,049	\$1,283,770	\$1,283,770	\$1,283,770	\$1,283,770	\$1,283,770	\$1,283,770	\$1,283,770	\$17,717	\$841,247	\$337,521	\$973,781
\$2,050	\$1,264,103	\$1,264,103	\$1,264,103	\$1,264,103	\$1,264,103	\$1,264,103	\$1,264,103	\$5,300	\$828,359	\$332,351	\$958,863
\$2,051	\$1,244,737	\$1,244,737	\$1,244,737	\$1,244,737	\$1,244,737	\$1,244,737	\$1,244,737	\$2,882	\$815,669	\$327,259	\$944,173
\$2,052	\$1,225,667	\$1,225,667	\$1,225,667	\$1,225,667	\$1,225,667	\$1,225,667	\$1,225,667	\$422	\$803,173	\$322,245	\$929,708
\$2,053	\$1,206,890	\$1,206,890	\$1,206,890	\$1,206,890	\$1,206,890	\$1,206,890	\$1,206,890	\$272	\$790,868	\$317,309	\$915,465
\$2,054	\$1,188,400	\$1,188,400	\$1,188,400	\$1,188,400	\$1,188,400	\$1,188,400	\$1,188,400	\$122	\$778,752	\$312,447	\$901,440
\$2,055	\$1,170,194	\$1,170,194	\$1,170,194	\$1,170,194	\$1,170,194	\$1,170,194	\$1,170,194	\$72	\$766,822	\$307,661	\$887,630
\$2,056	\$1,152,267	\$1,152,267	\$1,152,267	\$1,152,267	\$1,152,267	\$1,152,267	\$1,152,267	\$22	\$755,074	\$302,947	\$874,032
\$2,057	\$1,134,614	\$1,134,614	\$1,134,614	\$1,134,614	\$1,134,614	\$1,134,614	\$1,134,614	\$72	\$743,506	\$298,306	\$860,642
\$2,058	\$1,117,232	\$1,117,232	\$1,117,232	\$1,117,232	\$1,117,232	\$1,117,232	\$1,117,232	\$22	\$732,116	\$293,736	\$847,456
\$2,059	\$1,100,116	\$1,100,116	\$1,100,116	\$1,100,116	\$1,100,116	\$1,100,116	\$1,100,116	\$72	\$720,900	\$289,236	\$834,473
\$2,060	\$1,083,262	\$1,083,262	\$1,083,262	\$1,083,262	\$1,083,262	\$1,083,262	\$1,083,262	\$22	\$709,855	\$284,805	\$821,689
\$2,061	\$1,066,666	\$1,066,666	\$1,066,666	\$1,066,666	\$1,066,666	\$1,066,666	\$1,066,666	\$72	\$699,800	\$280,442	\$809,101
\$2,062	\$1,050,325	\$1,050,325	\$1,050,325	\$1,050,325	\$1,050,325	\$1,050,325	\$1,050,325	\$22	\$689,745	\$276,145	\$796,706
\$2,063	\$1,034,234	\$1,034,234	\$1,034,234	\$1,034,234	\$1,034,234	\$1,034,234	\$1,034,234	\$72	\$679,690	\$271,915	\$784,500
\$2,064	\$1,018,390	\$1,018,390	\$1,018,390	\$1,018,390	\$1,018,390	\$1,018,390	\$1,018,390	\$22	\$669,635	\$267,749	\$772,482
\$2,065	\$1,002,788	\$1,002,788	\$1,002,788	\$1,002,788	\$1,002,788	\$1,002,788	\$1,002,788	\$72	\$659,580	\$263,547	\$760,647
SUM:	\$75,019,478	\$75,019,478	\$75,019,478	\$75,019,478	\$75,019,478	\$75,019,478	\$75,019,478	\$149,943,183	\$49,159,836	\$19,723,690	\$56,904,708

EN-06 Transmission Reliability

risk cost of biosolid transportation

	Transmission				Score
	Distance Trucked	# of loads	Transmission Risk	NPV	
Dried Fertilizer	34	225	\$7,650	\$268,588	5
Top Soil Blend	34	225	\$7,650	\$268,588	5
Mine Reclamation	200	225	\$45,000	\$1,579,931	2
Land Application	100	225	\$22,500	\$789,966	4
Biomass Production	200	225	\$45,000	\$1,579,931	2
Compost Product	34	225	\$7,650	\$268,588	5
Cement Kiln Fuel	30	225	\$6,750	\$236,990	5
WTE - A	0	0	\$0	\$0	5
WTE - B	0	0	\$0	\$0	5
WTE - C	34	470	\$15,980	\$561,051	4
WTE - D	34	225	\$7,650	\$268,588	5

Notes:

Risk cost of \$1 per km traveled assumed

This impact represents the risk cost involved with a failure during transmission of biosolids.

Calculation:

Transmission Risk = Risk Cost / (Distance x # of loads)

Scoring:

- 1 More than \$2 million
- 2 \$1.5 million to \$2 million
- 3 \$1 million to \$1.5 million
- 4 \$500,000 to \$1 million
- 5 Less than \$500,000

NPV Calculation

Year	Dried Fertilizer		Top Soil Blend	Mine Reclamation	Land Application	Biomass Production	Compost Product	Cement Kiln Fuel	WTE - A	WTE - B	WTE - C	WTE - D
	Fertilizer	Blend										
2016	\$7,650	\$7,650	\$45,000	\$22,500	\$45,000	\$7,650	\$6,750	\$0	\$0	\$15,980	\$7,650	
2017	\$7,533	\$7,533	\$44,311	\$22,155	\$44,311	\$7,533	\$6,647	\$0	\$0	\$15,735	\$7,533	
2018	\$7,417	\$7,417	\$43,632	\$21,816	\$43,632	\$7,417	\$6,545	\$0	\$0	\$15,494	\$7,417	
2019	\$7,304	\$7,304	\$42,963	\$21,482	\$42,963	\$7,304	\$6,444	\$0	\$0	\$15,257	\$7,304	
2020	\$7,192	\$7,192	\$42,305	\$21,153	\$42,305	\$7,192	\$6,346	\$0	\$0	\$15,023	\$7,192	
2021	\$7,082	\$7,082	\$41,657	\$20,829	\$41,657	\$7,082	\$6,249	\$0	\$0	\$14,793	\$7,082	
2022	\$6,973	\$6,973	\$41,019	\$20,509	\$41,019	\$6,973	\$6,153	\$0	\$0	\$14,566	\$6,973	
2023	\$6,866	\$6,866	\$40,390	\$20,195	\$40,390	\$6,866	\$6,059	\$0	\$0	\$14,343	\$6,866	
2024	\$6,761	\$6,761	\$39,772	\$19,886	\$39,772	\$6,761	\$5,966	\$0	\$0	\$14,123	\$6,761	
2025	\$6,658	\$6,658	\$39,162	\$19,581	\$39,162	\$6,658	\$5,874	\$0	\$0	\$13,907	\$6,658	
2026	\$6,556	\$6,556	\$38,562	\$19,281	\$38,562	\$6,556	\$5,784	\$0	\$0	\$13,694	\$6,556	
2027	\$6,455	\$6,455	\$37,972	\$18,986	\$37,972	\$6,455	\$5,696	\$0	\$0	\$13,484	\$6,455	
2028	\$6,356	\$6,356	\$37,390	\$18,695	\$37,390	\$6,356	\$5,608	\$0	\$0	\$13,278	\$6,356	
2029	\$6,259	\$6,259	\$36,817	\$18,409	\$36,817	\$6,259	\$5,523	\$0	\$0	\$13,074	\$6,259	
2030	\$6,163	\$6,163	\$36,253	\$18,127	\$36,253	\$6,163	\$5,438	\$0	\$0	\$12,874	\$6,163	
2031	\$6,069	\$6,069	\$35,698	\$17,849	\$35,698	\$6,069	\$5,355	\$0	\$0	\$12,677	\$6,069	
2032	\$5,976	\$5,976	\$35,151	\$17,575	\$35,151	\$5,976	\$5,273	\$0	\$0	\$12,482	\$5,976	
2033	\$5,884	\$5,884	\$34,612	\$17,306	\$34,612	\$5,884	\$5,192	\$0	\$0	\$12,291	\$5,884	
2034	\$5,794	\$5,794	\$34,082	\$17,041	\$34,082	\$5,794	\$5,112	\$0	\$0	\$12,103	\$5,794	
2035	\$5,705	\$5,705	\$33,560	\$16,780	\$33,560	\$5,705	\$5,034	\$0	\$0	\$11,917	\$5,705	
2036	\$5,618	\$5,618	\$33,046	\$16,523	\$33,046	\$5,618	\$4,957	\$0	\$0	\$11,735	\$5,618	
2037	\$5,532	\$5,532	\$32,539	\$16,270	\$32,539	\$5,532	\$4,881	\$0	\$0	\$11,555	\$5,532	
2038	\$5,447	\$5,447	\$32,041	\$16,020	\$32,041	\$5,447	\$4,806	\$0	\$0	\$11,378	\$5,447	
2039	\$5,364	\$5,364	\$31,550	\$15,775	\$31,550	\$5,364	\$4,733	\$0	\$0	\$11,204	\$5,364	
2040	\$5,281	\$5,281	\$31,067	\$15,533	\$31,067	\$5,281	\$4,660	\$0	\$0	\$11,032	\$5,281	
2041	\$5,200	\$5,200	\$30,591	\$15,295	\$30,591	\$5,200	\$4,589	\$0	\$0	\$10,863	\$5,200	
2042	\$5,121	\$5,121	\$30,122	\$15,061	\$30,122	\$5,121	\$4,518	\$0	\$0	\$10,697	\$5,121	
2043	\$5,042	\$5,042	\$29,661	\$14,830	\$29,661	\$5,042	\$4,449	\$0	\$0	\$10,533	\$5,042	
2044	\$4,965	\$4,965	\$29,206	\$14,603	\$29,206	\$4,965	\$4,381	\$0	\$0	\$10,371	\$4,965	
2045	\$4,889	\$4,889	\$28,759	\$14,379	\$28,759	\$4,889	\$4,314	\$0	\$0	\$10,213	\$4,889	
2046	\$4,814	\$4,814	\$28,318	\$14,159	\$28,318	\$4,814	\$4,248	\$0	\$0	\$10,056	\$4,814	
2047	\$4,740	\$4,740	\$27,884	\$13,942	\$27,884	\$4,740	\$4,183	\$0	\$0	\$9,902	\$4,740	
2048	\$4,668	\$4,668	\$27,457	\$13,729	\$27,457	\$4,668	\$4,119	\$0	\$0	\$9,750	\$4,668	
2049	\$4,596	\$4,596	\$27,037	\$13,518	\$27,037	\$4,596	\$4,055	\$0	\$0	\$9,601	\$4,596	
2050	\$4,526	\$4,526	\$26,622	\$13,311	\$26,622	\$4,526	\$3,993	\$0	\$0	\$9,454	\$4,526	
2051	\$4,456	\$4,456	\$26,215	\$13,107	\$26,215	\$4,456	\$3,932	\$0	\$0	\$9,309	\$4,456	
2052	\$4,388	\$4,388	\$25,813	\$12,906	\$25,813	\$4,388	\$3,872	\$0	\$0	\$9,166	\$4,388	
2053	\$4,321	\$4,321	\$25,417	\$12,709	\$25,417	\$4,321	\$3,813	\$0	\$0	\$9,026	\$4,321	
2054	\$4,255	\$4,255	\$25,028	\$12,514	\$25,028	\$4,255	\$3,754	\$0	\$0	\$8,888	\$4,255	
2055	\$4,190	\$4,190	\$24,645	\$12,322	\$24,645	\$4,190	\$3,697	\$0	\$0	\$8,752	\$4,190	
2056	\$4,125	\$4,125	\$24,267	\$12,134	\$24,267	\$4,125	\$3,640	\$0	\$0	\$8,618	\$4,125	
2057	\$4,062	\$4,062	\$23,895	\$11,948	\$23,895	\$4,062	\$3,584	\$0	\$0	\$8,485	\$4,062	
2058	\$4,000	\$4,000	\$23,529	\$11,765	\$23,529	\$4,000	\$3,529	\$0	\$0	\$8,355	\$4,000	
2059	\$3,939	\$3,939	\$23,169	\$11,584	\$23,169	\$3,939	\$3,475	\$0	\$0	\$8,227	\$3,939	
2060	\$3,878	\$3,878	\$22,814	\$11,407	\$22,814	\$3,878	\$3,422	\$0	\$0	\$8,101	\$3,878	
2061	\$3,819	\$3,819	\$22,464	\$11,232	\$22,464	\$3,819	\$3,370	\$0	\$0	\$7,977	\$3,819	
2062	\$3,760	\$3,760	\$22,120	\$11,060	\$22,120	\$3,760	\$3,318	\$0	\$0	\$7,855	\$3,760	
2063	\$3,703	\$3,703	\$21,781	\$10,891	\$21,781	\$3,703	\$3,267	\$0	\$0	\$7,735	\$3,703	
2064	\$3,646	\$3,646	\$21,448	\$10,724	\$21,448	\$3,646	\$3,217	\$0	\$0	\$7,616	\$3,646	
2065	\$3,590	\$3,590	\$21,119	\$10,559	\$21,119	\$3,590	\$3,168	\$0	\$0	\$7,500	\$3,590	
SUM:	\$268,588	\$268,588	\$1,579,931	\$789,966	\$1,579,931	\$268,588	\$236,990	\$0	\$0	\$561,051	\$268,588	

EN-07 Site Remediation

Risk cost of remediation activities and delays

	<i>Site Remediation Costs</i>				Score	
	Estimated Construction Cost	Delay Caused by Remediation	Probability of Delay	Site Area Requiring Remediation		
Dried Fertilizer	\$254,900,000	1	75%	1.8	\$6,140,250	3
Top Soil Blend	\$259,770,200	1	75%	1.8	\$6,249,830	3
Mine Reclamation	\$255,344,000	1	75%	1.8	\$6,150,240	3
Land Application	\$255,344,000	1	75%	1.8	\$6,150,240	3
Biomass Production	\$262,717,200	1	75%	1.8	\$6,316,137	3
Compost Product	\$262,902,800	1	75%	1.8	\$6,320,313	3
Cement Kiln Fuel	\$254,900,000	1	75%	1.8	\$6,140,250	3
WTE - A	\$270,121,000	1	75%	1.8	\$6,482,723	3
WTE - B	\$292,986,000	1	75%	1.8	\$6,997,185	3
WTE - C	\$252,308,000	1	75%	1.8	\$6,081,930	3
WTE - D	\$265,397,000	1	75%	1.8	\$6,376,433	3

Calculation:

Remediation Cost = Probability of Delay x [Construction Cost x (1 + inflation)^
Delay Period + Area Requiring Remediation x Cost to Remediate]

Scoring:

- 1 More than \$11 million
- 2 \$8 to \$11 million
- 3 \$5 to \$8 million
- 4 \$2 to \$5 million
- 5 Less than \$2 million

Assumptions: Value Reference/Basis

Cost per hectare of remediation: \$300,000 per hectare

Notes:

This impact represents the risk cost associated with potential site contamination.

EN-08 Pollution Discharge

Tons of pollutant discharged

	Pollution Discharge				Score	
	NO _x Emissions	Lead	Mercury	Pollution Cost		
Dried Fertilizer	0	390	15	\$40,500	\$1,440,654	3
Top Soil Blend	0	390	15	\$40,500	\$1,440,654	3
Mine Reclamation	0	390	15	\$40,500	\$1,440,654	3
Land Application	0	390	15	\$40,500	\$1,440,654	3
Biomass Production	0	390	15	\$40,500	\$1,440,654	3
Compost Product	0	390	15	\$40,500	\$1,440,654	3
Cement Kiln Fuel	18,258	390	15	\$40,758	\$1,449,832	3
WTE - A	17,345	390	15	\$39,845	\$1,417,355	3
WTE - B	17,345	390	15	\$39,845	\$1,417,355	3
WTE - C	17,345	390	15	\$39,845	\$1,417,355	3
WTE - D	17,345	390	15	\$39,845	\$1,417,355	3

Notes:

- Assumed a \$100 per kg value for solids in land application options
- Assumed a \$50 per kg cost for lead in fly ash from combustion options
- Assumed a \$200 per kg cost for mercury volatilized in combustion options
- Assumed a \$1 per kg value for NO_x emissions
- This impact represents the risk cost associated with potential environmental contamination.

Calculation:

Pollution Cost = Air Emissions x Emissions Cost + Land Application x Land Cost

NPV Calculation

Year	Dried Fertilizer	Top Soil Blend	Mine Reclamation	Land Application	Biomass Production	Compost Product	Cement Kiln Fuel	WTE - A	WTE - B	WTE - C	WTE - D
\$2,015	\$40,500	\$40,500	\$40,500	\$40,500	\$40,500	\$40,500	\$40,758	\$39,845	\$39,845	\$39,845	\$39,845
\$2,016	\$39,880	\$39,880	\$39,880	\$39,880	\$39,880	\$39,880	\$40,134	\$39,235	\$39,235	\$39,235	\$39,235
\$2,017	\$39,269	\$39,269	\$39,269	\$39,269	\$39,269	\$39,269	\$39,519	\$38,624	\$38,624	\$38,624	\$38,624
\$2,018	\$38,667	\$38,667	\$38,667	\$38,667	\$38,667	\$38,667	\$38,913	\$38,042	\$38,042	\$38,042	\$38,042
\$2,019	\$38,075	\$38,075	\$38,075	\$38,075	\$38,075	\$38,075	\$38,317	\$37,459	\$37,459	\$37,459	\$37,459
\$2,020	\$37,491	\$37,491	\$37,491	\$37,491	\$37,491	\$37,491	\$37,730	\$36,885	\$36,885	\$36,885	\$36,885
\$2,021	\$36,917	\$36,917	\$36,917	\$36,917	\$36,917	\$36,917	\$37,152	\$36,320	\$36,320	\$36,320	\$36,320
\$2,022	\$36,351	\$36,351	\$36,351	\$36,351	\$36,351	\$36,351	\$36,583	\$35,763	\$35,763	\$35,763	\$35,763
\$2,023	\$35,794	\$35,794	\$35,794	\$35,794	\$35,794	\$35,794	\$36,022	\$35,216	\$35,216	\$35,216	\$35,216
\$2,024	\$35,246	\$35,246	\$35,246	\$35,246	\$35,246	\$35,246	\$36,471	\$34,676	\$34,676	\$34,676	\$34,676
\$2,025	\$34,706	\$34,706	\$34,706	\$34,706	\$34,706	\$34,706	\$34,927	\$34,145	\$34,145	\$34,145	\$34,145
\$2,026	\$34,174	\$34,174	\$34,174	\$34,174	\$34,174	\$34,174	\$34,392	\$33,622	\$33,622	\$33,622	\$33,622
\$2,027	\$33,651	\$33,651	\$33,651	\$33,651	\$33,651	\$33,651	\$33,865	\$33,107	\$33,107	\$33,107	\$33,107
\$2,028	\$33,135	\$33,135	\$33,135	\$33,135	\$33,135	\$33,135	\$33,346	\$32,599	\$32,599	\$32,599	\$32,599
\$2,029	\$32,628	\$32,628	\$32,628	\$32,628	\$32,628	\$32,628	\$32,836	\$32,100	\$32,100	\$32,100	\$32,100
\$2,030	\$32,128	\$32,128	\$32,128	\$32,128	\$32,128	\$32,128	\$32,333	\$31,608	\$31,608	\$31,608	\$31,608
\$2,031	\$31,636	\$31,636	\$31,636	\$31,636	\$31,636	\$31,636	\$31,837	\$31,124	\$31,124	\$31,124	\$31,124
\$2,032	\$31,151	\$31,151	\$31,151	\$31,151	\$31,151	\$31,151	\$31,349	\$30,647	\$30,647	\$30,647	\$30,647
\$2,033	\$30,674	\$30,674	\$30,674	\$30,674	\$30,674	\$30,674	\$30,869	\$30,178	\$30,178	\$30,178	\$30,178
\$2,034	\$30,204	\$30,204	\$30,204	\$30,204	\$30,204	\$30,204	\$30,396	\$29,715	\$29,715	\$29,715	\$29,715
\$2,035	\$29,741	\$29,741	\$29,741	\$29,741	\$29,741	\$29,741	\$29,931	\$29,260	\$29,260	\$29,260	\$29,260
\$2,036	\$29,285	\$29,285	\$29,285	\$29,285	\$29,285	\$29,285	\$29,472	\$28,812	\$28,812	\$28,812	\$28,812
\$2,037	\$28,837	\$28,837	\$28,837	\$28,837	\$28,837	\$28,837	\$29,021	\$28,370	\$28,370	\$28,370	\$28,370
\$2,038	\$28,395	\$28,395	\$28,395	\$28,395	\$28,395	\$28,395	\$28,576	\$27,936	\$27,936	\$27,936	\$27,936
\$2,039	\$27,960	\$27,960	\$27,960	\$27,960	\$27,960	\$27,960	\$28,138	\$27,508	\$27,508	\$27,508	\$27,508
\$2,040	\$27,532	\$27,532	\$27,532	\$27,532	\$27,532	\$27,532	\$27,707	\$27,086	\$27,086	\$27,086	\$27,086
\$2,041	\$27,110	\$27,110	\$27,110	\$27,110	\$27,110	\$27,110	\$27,283	\$26,671	\$26,671	\$26,671	\$26,671
\$2,042	\$26,695	\$26,695	\$26,695	\$26,695	\$26,695	\$26,695	\$26,865	\$26,263	\$26,263	\$26,263	\$26,263
\$2,043	\$26,286	\$26,286	\$26,286	\$26,286	\$26,286	\$26,286	\$26,453	\$25,861	\$25,861	\$25,861	\$25,861
\$2,044	\$25,883	\$25,883	\$25,883	\$25,883	\$25,883	\$25,883	\$26,048	\$25,464	\$25,464	\$25,464	\$25,464
\$2,045	\$25,486	\$25,486	\$25,486	\$25,486	\$25,486	\$25,486	\$25,649	\$25,074	\$25,074	\$25,074	\$25,074
\$2,046	\$25,096	\$25,096	\$25,096	\$25,096	\$25,096	\$25,096	\$25,256	\$24,690	\$24,690	\$24,690	\$24,690
\$2,047	\$24,711	\$24,711	\$24,711	\$24,711	\$24,711	\$24,711	\$24,869	\$24,312	\$24,312	\$24,312	\$24,312
\$2,048	\$24,333	\$24,333	\$24,333	\$24,333	\$24,333	\$24,333	\$24,488	\$23,939	\$23,939	\$23,939	\$23,939
\$2,049	\$23,960	\$23,960	\$23,960	\$23,960	\$23,960	\$23,960	\$24,113	\$23,573	\$23,573	\$23,573	\$23,573
\$2,050	\$23,593	\$23,593	\$23,593	\$23,593	\$23,593	\$23,593	\$23,743	\$23,211	\$23,211	\$23,211	\$23,211
\$2,051	\$23,232	\$23,232	\$23,232	\$23,232	\$23,232	\$23,232	\$23,380	\$22,856	\$22,856	\$22,856	\$22,856
\$2,052	\$22,876	\$22,876	\$22,876	\$22,876	\$22,876	\$22,876	\$23,021	\$22,506	\$22,506	\$22,506	\$22,506
\$2,053	\$22,525	\$22,525	\$22,525	\$22,525	\$22,525	\$22,525	\$22,669	\$22,161	\$22,161	\$22,161	\$22,161
\$2,054	\$22,180	\$22,180	\$22,180	\$22,180	\$22,180	\$22,180	\$22,321	\$21,821	\$21,821	\$21,821	\$21,821
\$2,055	\$21,840	\$21,840	\$21,840	\$21,840	\$21,840	\$21,840	\$21,979	\$21,487	\$21,487	\$21,487	\$21,487
\$2,056	\$21,506	\$21,506	\$21,506	\$21,506	\$21,506	\$21,506	\$21,643	\$21,158	\$21,158	\$21,158	\$21,158
\$2,057	\$21,176	\$21,176	\$21,176	\$21,176	\$21,176	\$21,176	\$21,311	\$20,834	\$20,834	\$20,834	\$20,834
\$2,058	\$20,852	\$20,852	\$20,852	\$20,852	\$20,852	\$20,852	\$20,985	\$20,515	\$20,515	\$20,515	\$20,515
\$2,059	\$20,532	\$20,532	\$20,532	\$20,532	\$20,532	\$20,532	\$20,663	\$20,200	\$20,200	\$20,200	\$20,200
\$2,060	\$20,218	\$20,218	\$20,218	\$20,218	\$20,218	\$20,218	\$20,347	\$19,891	\$19,891	\$19,891	\$19,891
\$2,061	\$19,908	\$19,908	\$19,908	\$19,908	\$19,908	\$19,908	\$20,035	\$19,586	\$19,586	\$19,586	\$19,586
\$2,062	\$19,603	\$19,603	\$19,603	\$19,603	\$19,603	\$19,603	\$19,728	\$19,286	\$19,286	\$19,286	\$19,286
\$2,063	\$19,303	\$19,303	\$19,303	\$19,303	\$19,303	\$19,303	\$19,426	\$18,991	\$18,991	\$18,991	\$18,991
\$2,064	\$19,007	\$19,007	\$19,007	\$19,007	\$19,007	\$19,007	\$19,128	\$18,700	\$18,700	\$18,700	\$18,700
\$2,065	\$18,716	\$18,716	\$18,716	\$18,716	\$18,716	\$18,716	\$18,835	\$18,413	\$18,413	\$18,413	\$18,413
SUM	\$1,440,654	\$1,440,654	\$1,440,654	\$1,440,654	\$1,440,654	\$1,440,654	\$1,449,832	\$1,417,355	\$1,417,355	\$1,417,355	\$1,417,355

EN-09 Non-Renewable Resource Use

Diesel fuel consumption during construction and operations

	Construction Cost	Diesel Consumption			Score	
		Distance Trucked	# of loads	NPV		
Dried Fertilizer	\$254,900,000	34	225	\$5,105,183	\$6,684,139	3
Top Soil Blend	\$259,770,200	34	225	\$5,202,587	\$6,781,543	3
Mine Reclamation	\$255,344,000	200	225	\$5,149,134	\$14,437,108	1
Land Application	\$255,344,000	100	225	\$5,128,007	\$9,771,994	2
Biomass Production	\$262,717,200	200	225	\$5,296,598	\$14,584,572	1
Compost Product	\$262,902,800	34	225	\$5,265,239	\$6,844,195	3
Cement Kiln Fuel	\$254,900,000	30	225	\$5,104,338	\$6,497,534	3
WTE - A	\$270,121,000	0	0	\$5,402,420	\$5,402,420	3
WTE - B	\$292,986,000	0	0	\$5,859,720	\$5,859,720	3
WTE - C	\$252,308,000	34	470	\$5,061,165	\$8,359,428	2
WTE - D	\$265,397,000	34	225	\$5,315,123	\$6,894,079	3

Assumptions:

Percent of Construction for Diesel:	2%
Fuel efficiency:	2.13 km/L
Fuel Cost	\$2 /L
Inflation of Diesel Fuel:	5%

Notes:
Risk associated with this impact was assumed to be negligible. Actual costs could be either higher or lower.

Calculation:

Diesel Cost = Construction Consumption + Trucking Consumption

Scoring:

- 1 More than \$11 million
- 2 \$8 to \$11 million
- 3 \$5 to \$8 million
- 4 \$2 to \$5 million
- 5 Less than \$2 million

NPV Calculation:

Year	Dried Fertilizer	Blend	Mine Reclamation	Land Application	Biomass Production	Compost	Cement Kiln Fuel	WTE - A	WTE - B	WTE - C	WTE - D
\$2,015	\$7,183	\$7,183	\$42,254	\$21,127	\$42,254	\$7,183	\$6,338	\$0	\$0	\$15,005	\$7,183
\$2,016	\$7,542	\$7,542	\$44,366	\$22,183	\$44,366	\$7,542	\$6,655	\$0	\$0	\$15,755	\$7,542
\$2,017	\$7,919	\$7,919	\$46,585	\$23,292	\$46,585	\$7,919	\$6,988	\$0	\$0	\$16,543	\$7,919
\$2,018	\$8,315	\$8,315	\$48,914	\$24,457	\$48,914	\$8,315	\$7,337	\$0	\$0	\$17,370	\$8,315
\$2,019	\$8,731	\$8,731	\$51,359	\$25,680	\$51,359	\$8,731	\$7,704	\$0	\$0	\$18,238	\$8,731
\$2,020	\$9,168	\$9,168	\$53,927	\$26,964	\$53,927	\$9,168	\$8,089	\$0	\$0	\$19,150	\$9,168
\$2,021	\$9,626	\$9,626	\$56,624	\$28,312	\$56,624	\$9,626	\$8,494	\$0	\$0	\$20,108	\$9,626
\$2,022	\$10,107	\$10,107	\$59,455	\$29,727	\$59,455	\$10,107	\$8,918	\$0	\$0	\$21,113	\$10,107
\$2,023	\$10,613	\$10,613	\$62,428	\$31,214	\$62,428	\$10,613	\$9,364	\$0	\$0	\$22,169	\$10,613
\$2,024	\$11,143	\$11,143	\$65,549	\$32,775	\$65,549	\$11,143	\$9,832	\$0	\$0	\$23,277	\$11,143
\$2,025	\$11,701	\$11,701	\$68,827	\$34,413	\$68,827	\$11,701	\$10,324	\$0	\$0	\$24,441	\$11,701
\$2,026	\$12,286	\$12,286	\$72,268	\$36,134	\$72,268	\$12,286	\$10,840	\$0	\$0	\$25,663	\$12,286
\$2,027	\$12,900	\$12,900	\$75,881	\$37,941	\$75,881	\$12,900	\$11,382	\$0	\$0	\$26,946	\$12,900
\$2,028	\$13,545	\$13,545	\$79,675	\$39,838	\$79,675	\$13,545	\$11,951	\$0	\$0	\$28,294	\$13,545
\$2,029	\$14,222	\$14,222	\$83,659	\$41,830	\$83,659	\$14,222	\$12,549	\$0	\$0	\$29,708	\$14,222
\$2,030	\$14,933	\$14,933	\$87,842	\$43,921	\$87,842	\$14,933	\$13,176	\$0	\$0	\$31,194	\$14,933
\$2,031	\$15,680	\$15,680	\$92,234	\$46,117	\$92,234	\$15,680	\$13,835	\$0	\$0	\$32,753	\$15,680
\$2,032	\$16,464	\$16,464	\$96,846	\$48,423	\$96,846	\$16,464	\$14,527	\$0	\$0	\$34,391	\$16,464
\$2,033	\$17,287	\$17,287	\$101,688	\$50,844	\$101,688	\$17,287	\$15,253	\$0	\$0	\$36,111	\$17,287
\$2,034	\$18,151	\$18,151	\$106,773	\$53,386	\$106,773	\$18,151	\$16,016	\$0	\$0	\$37,916	\$18,151
\$2,035	\$19,059	\$19,059	\$112,111	\$56,056	\$112,111	\$19,059	\$16,817	\$0	\$0	\$39,812	\$19,059
\$2,036	\$20,012	\$20,012	\$117,717	\$58,858	\$117,717	\$20,012	\$17,658	\$0	\$0	\$41,803	\$20,012
\$2,037	\$21,012	\$21,012	\$123,603	\$61,801	\$123,603	\$21,012	\$18,540	\$0	\$0	\$43,893	\$21,012
\$2,038	\$22,063	\$22,063	\$129,783	\$64,891	\$129,783	\$22,063	\$19,467	\$0	\$0	\$46,087	\$22,063
\$2,039	\$23,166	\$23,166	\$136,272	\$68,136	\$136,272	\$23,166	\$20,441	\$0	\$0	\$48,392	\$23,166
\$2,040	\$24,325	\$24,325	\$143,085	\$71,543	\$143,085	\$24,325	\$21,463	\$0	\$0	\$50,811	\$24,325
\$2,041	\$25,541	\$25,541	\$150,240	\$75,120	\$150,240	\$25,541	\$22,536	\$0	\$0	\$53,352	\$25,541
\$2,042	\$26,818	\$26,818	\$157,752	\$78,876	\$157,752	\$26,818	\$23,663	\$0	\$0	\$56,019	\$26,818
\$2,043	\$28,159	\$28,159	\$165,639	\$82,820	\$165,639	\$28,159	\$24,846	\$0	\$0	\$58,820	\$28,159
\$2,044	\$29,567	\$29,567	\$173,921	\$86,961	\$173,921	\$29,567	\$26,088	\$0	\$0	\$61,761	\$29,567
\$2,045	\$31,045	\$31,045	\$182,617	\$91,309	\$182,617	\$31,045	\$27,393	\$0	\$0	\$64,849	\$31,045
\$2,046	\$32,597	\$32,597	\$191,748	\$95,874	\$191,748	\$32,597	\$28,762	\$0	\$0	\$68,092	\$32,597
\$2,047	\$34,227	\$34,227	\$201,336	\$100,668	\$201,336	\$34,227	\$30,200	\$0	\$0	\$71,496	\$34,227
\$2,048	\$35,938	\$35,938	\$211,402	\$105,701	\$211,402	\$35,938	\$31,710	\$0	\$0	\$75,071	\$35,938
\$2,049	\$37,735	\$37,735	\$221,972	\$110,986	\$221,972	\$37,735	\$33,296	\$0	\$0	\$78,825	\$37,735
\$2,050	\$39,622	\$39,622	\$233,071	\$116,536	\$233,071	\$39,622	\$34,961	\$0	\$0	\$82,766	\$39,622
\$2,051	\$41,603	\$41,603	\$244,725	\$122,362	\$244,725	\$41,603	\$36,709	\$0	\$0	\$86,904	\$41,603
\$2,052	\$43,683	\$43,683	\$256,961	\$128,480	\$256,961	\$43,683	\$38,544	\$0	\$0	\$91,250	\$43,683
\$2,053	\$45,868	\$45,868	\$269,809	\$134,904	\$269,809	\$45,868	\$40,471	\$0	\$0	\$95,812	\$45,868
\$2,054	\$48,161	\$48,161	\$283,299	\$141,650	\$283,299	\$48,161	\$42,495	\$0	\$0	\$100,603	\$48,161
\$2,055	\$50,569	\$50,569	\$297,464	\$148,732	\$297,464	\$50,569	\$44,620	\$0	\$0	\$105,633	\$50,569
\$2,056	\$53,097	\$53,097	\$312,338	\$156,169	\$312,338	\$53,097	\$46,851	\$0	\$0	\$110,915	\$53,097
\$2,057	\$55,752	\$55,752	\$327,954	\$163,977	\$327,954	\$55,752	\$49,193	\$0	\$0	\$116,460	\$55,752
\$2,058	\$58,540	\$58,540	\$344,352	\$172,176	\$344,352	\$58,540	\$51,653	\$0	\$0	\$122,283	\$58,540
\$2,059	\$61,467	\$61,467	\$361,570	\$180,785	\$361,570	\$61,467	\$54,235	\$0	\$0	\$128,397	\$61,467
\$2,060	\$64,540	\$64,540	\$379,648	\$189,824	\$379,648	\$64,540	\$56,947	\$0	\$0	\$134,817	\$64,540
\$2,061	\$67,767	\$67,767	\$398,631	\$199,315	\$398,631	\$67,767	\$59,795	\$0	\$0	\$141,558	\$67,767
\$2,062	\$71,156	\$71,156	\$418,562	\$209,281	\$418,562	\$71,156	\$62,784	\$0	\$0	\$148,636	\$71,156
\$2,063	\$74,713	\$74,713	\$439,490	\$219,745	\$439,490	\$74,713	\$65,924	\$0	\$0	\$156,068	\$74,713
\$2,064	\$78,449	\$78,449	\$461,465	\$230,732	\$461,465	\$78,449	\$69,220	\$0	\$0	\$163,871	\$78,449
\$2,065	\$82,371	\$82,371	\$484,538	\$242,269	\$484,538	\$82,371	\$72,681	\$0	\$0	\$172,065	\$82,371
SUM:	\$1,586,139	\$1,586,139	\$9,330,228	\$4,665,114	\$9,330,228	\$1,586,139	\$1,399,534	\$0	\$0	\$3,313,268	\$1,586,139

EN-10 Non-Renewable Resource Generated

Revenue generated from struvite and biosolids production

	Non-Renewable Resources Generated				Score
	Struvite Production	Biosolids Produced	Value of Non-Renewables	NPV	
Dried Fertilizer	250	6,120	\$475,522	\$16,915,115	4
Top Soil Blend	250	6,120	\$607,897	\$21,623,941	5
Mine Reclamation	250	6,120	\$300,000	\$10,671,512	3
Land Application	250	6,120	\$300,000	\$10,671,512	3
Biomass Production	250	6,120	\$347,369	\$12,356,501	3
Compost Product	250	6,120	\$621,300	\$22,100,701	5
Cement Kln Fuel	250	6,120	\$475,522	\$16,915,115	4
WTE - A	0	0	\$0	\$0	1
WTE - B	250	0	\$300,000	\$10,671,512	3
WTE - C	0	0	\$0	\$0	1
WTE - D	250	0	\$300,000	\$10,671,512	3

Assumptions:

Value	Reference/Basis
Value for Struvite:	\$1,200 per tonne
Revenue for Cement Kln Biosolids:	\$29 per tonne
Revenue for Top Soil Blend:	\$50 per tonne
Revenue for Biomass Product:	\$8 per tonne
Revenue for Dried Fertilizer Biosolids:	\$29 per tonne
Revenue for Compost Product:	\$53 per tonne

Assume no value for mine reclamation or land application

Notes:

Risk associated with this impact was assumed to be negligible. Actual revenues could be either higher or lower.

Calculation:

Value of Non-Renewables = Struvite Produced x Value of Struvite + Biosolids Produced x Value of Biosolids

Scoring:

- 1 Less than \$5 million
- 2 \$5 to \$10 million
- 3 \$10 to \$15 million
- 4 \$15 to \$20 million
- 5 More than \$20 million

NPV Calculation

Year	Fertilizer	Top Soil Blend	Mine Reclamation	Land Application	Biomass Production	Compost Product	Cement Kln Fuel	WTE - A	WTE - B	WTE - C	WTE - D
2015	\$475,522	\$607,897	\$300,000	\$300,000	\$347,369	\$621,300	\$475,522	\$0	\$300,000	\$0	\$300,000
2016	\$468,237	\$598,584	\$295,404	\$295,404	\$342,047	\$611,782	\$468,237	\$0	\$295,404	\$0	\$295,404
2017	\$461,063	\$589,414	\$290,878	\$290,878	\$336,807	\$602,409	\$461,063	\$0	\$290,878	\$0	\$290,878
2018	\$454,000	\$580,384	\$286,422	\$286,422	\$331,647	\$593,180	\$454,000	\$0	\$286,422	\$0	\$286,422
2019	\$447,044	\$571,493	\$282,034	\$282,034	\$326,566	\$584,093	\$447,044	\$0	\$282,034	\$0	\$282,034
2020	\$440,196	\$562,737	\$277,713	\$277,713	\$321,563	\$575,144	\$440,196	\$0	\$277,713	\$0	\$277,713
2021	\$433,452	\$554,116	\$273,459	\$273,459	\$316,637	\$566,333	\$433,452	\$0	\$273,459	\$0	\$273,459
2022	\$426,811	\$545,627	\$269,269	\$269,269	\$311,786	\$557,657	\$426,811	\$0	\$269,269	\$0	\$269,269
2023	\$420,273	\$537,268	\$265,144	\$265,144	\$307,009	\$549,114	\$420,273	\$0	\$265,144	\$0	\$265,144
2024	\$413,834	\$529,037	\$261,082	\$261,082	\$302,306	\$540,701	\$413,834	\$0	\$261,082	\$0	\$261,082
2025	\$407,494	\$520,932	\$257,082	\$257,082	\$297,675	\$532,418	\$407,494	\$0	\$257,082	\$0	\$257,082
2026	\$401,251	\$512,952	\$253,144	\$253,144	\$293,114	\$524,261	\$401,251	\$0	\$253,144	\$0	\$253,144
2027	\$395,104	\$505,093	\$249,266	\$249,266	\$288,624	\$516,229	\$395,104	\$0	\$249,266	\$0	\$249,266
2028	\$389,051	\$497,355	\$245,447	\$245,447	\$284,202	\$508,321	\$389,051	\$0	\$245,447	\$0	\$245,447
2029	\$383,091	\$489,736	\$241,687	\$241,687	\$279,848	\$500,533	\$383,091	\$0	\$241,687	\$0	\$241,687
2030	\$377,222	\$482,233	\$237,984	\$237,984	\$275,561	\$492,865	\$377,222	\$0	\$237,984	\$0	\$237,984
2031	\$371,443	\$474,845	\$234,338	\$234,338	\$271,339	\$485,314	\$371,443	\$0	\$234,338	\$0	\$234,338
2032	\$365,752	\$467,571	\$230,748	\$230,748	\$267,182	\$477,879	\$365,752	\$0	\$230,748	\$0	\$230,748
2033	\$360,149	\$460,407	\$227,213	\$227,213	\$263,089	\$470,558	\$360,149	\$0	\$227,213	\$0	\$227,213
2034	\$354,632	\$453,354	\$223,732	\$223,732	\$259,059	\$463,349	\$354,632	\$0	\$223,732	\$0	\$223,732
2035	\$349,199	\$446,409	\$220,305	\$220,305	\$255,090	\$456,251	\$349,199	\$0	\$220,305	\$0	\$220,305
2036	\$343,849	\$439,570	\$216,930	\$216,930	\$251,182	\$449,261	\$343,849	\$0	\$216,930	\$0	\$216,930
2037	\$338,581	\$432,835	\$213,606	\$213,606	\$247,334	\$442,378	\$338,581	\$0	\$213,606	\$0	\$213,606
2038	\$333,394	\$426,204	\$210,334	\$210,334	\$243,545	\$435,601	\$333,394	\$0	\$210,334	\$0	\$210,334
2039	\$328,287	\$419,675	\$207,111	\$207,111	\$239,813	\$428,928	\$328,287	\$0	\$207,111	\$0	\$207,111
2040	\$323,257	\$413,245	\$203,938	\$203,938	\$236,140	\$422,357	\$323,257	\$0	\$203,938	\$0	\$203,938
2041	\$318,305	\$406,915	\$200,814	\$200,814	\$232,522	\$415,886	\$318,305	\$0	\$200,814	\$0	\$200,814
2042	\$313,428	\$400,681	\$197,738	\$197,738	\$228,960	\$409,515	\$313,428	\$0	\$197,738	\$0	\$197,738
2043	\$308,627	\$394,542	\$194,708	\$194,708	\$225,452	\$403,241	\$308,627	\$0	\$194,708	\$0	\$194,708
2044	\$303,899	\$388,498	\$191,725	\$191,725	\$221,998	\$397,063	\$303,899	\$0	\$191,725	\$0	\$191,725
2045	\$299,243	\$382,546	\$188,788	\$188,788	\$218,597	\$390,980	\$299,243	\$0	\$188,788	\$0	\$188,788
2046	\$294,658	\$376,685	\$185,896	\$185,896	\$215,248	\$384,990	\$294,658	\$0	\$185,896	\$0	\$185,896
2047	\$290,144	\$370,915	\$183,048	\$183,048	\$211,951	\$379,092	\$290,144	\$0	\$183,048	\$0	\$183,048
2048	\$285,699	\$365,232	\$180,244	\$180,244	\$208,703	\$373,285	\$285,699	\$0	\$180,244	\$0	\$180,244
2049	\$281,322	\$359,637	\$177,482	\$177,482	\$205,506	\$367,566	\$281,322	\$0	\$177,482	\$0	\$177,482
2050	\$277,012	\$354,127	\$174,763	\$174,763	\$202,358	\$361,935	\$277,012	\$0	\$174,763	\$0	\$174,763
2051	\$272,769	\$348,702	\$172,086	\$172,086	\$199,258	\$356,390	\$272,769	\$0	\$172,086	\$0	\$172,086
2052	\$268,590	\$343,360	\$169,450	\$169,450	\$196,205	\$350,930	\$268,590	\$0	\$169,450	\$0	\$169,450
2053	\$264,475	\$338,100	\$166,854	\$166,854	\$193,199	\$345,554	\$264,475	\$0	\$166,854	\$0	\$166,854
2054	\$260,423	\$332,920	\$164,297	\$164,297	\$190,239	\$340,260	\$260,423	\$0	\$164,297	\$0	\$164,297
2055	\$256,434	\$327,820	\$161,780	\$161,780	\$187,325	\$335,047	\$256,434	\$0	\$161,780	\$0	\$161,780
2056	\$252,505	\$322,797	\$159,302	\$159,302	\$184,455	\$329,914	\$252,505	\$0	\$159,302	\$0	\$159,302
2057	\$248,637	\$317,852	\$156,861	\$156,861	\$181,629	\$324,860	\$248,637	\$0	\$156,861	\$0	\$156,861
2058	\$244,828	\$312,983	\$154,458	\$154,458	\$178,847	\$319,883	\$244,828	\$0	\$154,458	\$0	\$154,458
2059	\$241,077	\$308,188	\$152,092	\$152,092	\$176,107	\$314,983	\$241,077	\$0	\$152,092	\$0	\$152,092
2060	\$237,383	\$303,466	\$149,762	\$149,762	\$173,409	\$310,157	\$237,383	\$0	\$149,762	\$0	\$149,762
2061	\$233,747	\$298,817	\$147,468	\$147,468	\$170,752	\$305,405	\$233,747	\$0	\$147,468	\$0	\$147,468
2062	\$230,166	\$294,239	\$145,208	\$145,208	\$168,136	\$300,727	\$230,166	\$0	\$145,208	\$0	\$145,208
2063	\$226,640	\$289,732	\$142,984	\$142,984	\$165,560	\$296,119	\$226,640	\$0	\$142,984	\$0	\$142,984
2064	\$223,168	\$285,293	\$140,793	\$140,793	\$163,024	\$291,583	\$223,168	\$0	\$140,793	\$0	\$140,793
2065	\$219,749	\$280,922	\$138,636	\$138,636	\$160,526	\$287,116	\$219,749	\$0	\$138,636	\$0	\$138,636
SUM	\$16,915,115	\$21,623,941	\$10,671,512	\$10,671,512	\$12,356,501	\$22,100,701	\$16,915,115	\$0	\$10,671,512	\$0	\$10,671,512

EN-11 Flexibility for Future Resource Recovery

Additional space needed to add 100% additional resource recovery

	<i>Future Resource Recovery</i>			Score
	Used Site Area	Percent Expansion Needed	Future Resource Recovery Cost	
Dried Fertilizer	1.80	100%	\$3,600,000	3
Top Soil Blend	1.80	100%	\$3,600,000	3
Mine Reclamation	1.80	100%	\$3,600,000	3
Land Application	1.80	100%	\$3,600,000	3
Biomass Production	1.80	100%	\$3,600,000	3
Compost Product	1.80	100%	\$3,600,000	3
Cement Kiln Fuel	1.80	100%	\$3,600,000	3
WTE - A	1.30	100%	\$1,600,000	4
WTE - B	1.80	100%	\$3,600,000	3
WTE - C	1.00	100%	\$400,000	5
WTE - D	1.80	100%	\$3,600,000	3

Calculation:

Future Regulation Cost = Used Site Area x (1 - percent expansion available) x cost of additional space

Scoring:

- 1 More than \$7 million
- 2 \$5 to \$7 million
- 3 \$3 to \$5 million
- 4 \$1 to \$3 million
- 5 Less than \$1 million

Assumptions: Value Reference/Basis

Cost of additional space \$2,000,000

Notes:

This impact represents the risk cost of future needs resulting in a demand for additional resource recovery. Used site area represents the processing site and not the Hartland landfill site or utilization sites.

EN-12 Terrestrial and Inter-tidal habitat Impacts

Area of habitat potentially impacted

	<i>Habitat Impact</i>		Score
	Sensitive Habitats Impacted	Cost of habitat impacts	
Dried Fertilizer	none	\$0	5
Top Soil Blend	none	\$0	5
Mine Reclamation	none	\$0	5
Land Application	none	\$0	5
Biomass Production	none	\$0	5
Compost Product	none	\$0	5
Cement Kiln Fuel	none	\$0	5
WTE - A	none	\$0	5
WTE - B	none	\$0	5
WTE - C	none	\$0	5
WTE - D	none	\$0	5

Calculation:

Habitat Impact = Habitats Impacted x Cost of Impact

Scoring:

- 1 More than \$5 million
- 2 \$4 to \$5 million
- 3 \$3 to \$4 million
- 4 \$2 to \$3 million
- 5 Less than \$2 million

Notes:

Assumed a \$1,000,000 mitigation cost per habitat site impacted

Risk associated with this impact were assumed to be negligible as no sensitive habitats are expected to be impacted.

SO-02 Operations Traffic in Sensitive Areas

Cost of traffic inconvenience during operations

	Operations Traffic			Score	
	2005 Average Traffic Count	# of loads	Cost of Traffic		
Dried Fertilizer	19,750	225	\$22,219	\$790,359	4
Top Soil Blend	19,750	225	\$22,219	\$790,359	4
Mine Reclamation	19,750	225	\$22,219	\$790,359	4
Land Application	19,750	225	\$22,219	\$790,359	4
Biomass Production	19,750	225	\$22,219	\$790,359	4
Compost Product	19,750	225	\$22,219	\$790,359	4
Cement Kiln Fuel	19,750	225	\$22,219	\$790,359	4
WTE - A	19,750	0	\$0	\$0	5
WTE - B	19,750	0	\$0	\$0	5
WTE - C	19,750	470	\$46,413	\$1,650,972	2
WTE - D	19,750	225	\$22,219	\$790,359	4

Assumptions:

One existing trip impacted by one operations trip costs \$0.50
 Probability of existing traffic impacted by operations is 1%

Note:

This impact represents a risk cost borne by the community

Calculation:

Operations Traffic Cost = # of cars on road x (# of operations trips x probability of traffic increase) x cost of impact

Scoring:

- 1 More than \$2 million
- 2 \$1.5 to \$2 million
- 3 \$1 to \$1.5 million
- 4 \$500,000 to \$1 million
- 5 Less than \$500,000

NPV Calculation

Year	Dried Fertilizer	Top Soil Blend	Mine Reclamation	Land Application	Biomass Production	Compost Product	Cement Kiln Fuel	WTE - A	WTE - B	WTE - C	WTE - D
\$2,015	\$22,219	\$22,219	\$22,219	\$22,219	\$22,219	\$22,219	\$22,219	\$0	\$0	\$46,413	\$22,219
\$2,016	\$21,878	\$21,878	\$21,878	\$21,878	\$21,878	\$21,878	\$21,878	\$0	\$0	\$45,701	\$21,878
\$2,017	\$21,543	\$21,543	\$21,543	\$21,543	\$21,543	\$21,543	\$21,543	\$0	\$0	\$45,001	\$21,543
\$2,018	\$21,213	\$21,213	\$21,213	\$21,213	\$21,213	\$21,213	\$21,213	\$0	\$0	\$44,312	\$21,213
\$2,019	\$20,888	\$20,888	\$20,888	\$20,888	\$20,888	\$20,888	\$20,888	\$0	\$0	\$43,633	\$20,888
\$2,020	\$20,568	\$20,568	\$20,568	\$20,568	\$20,568	\$20,568	\$20,568	\$0	\$0	\$42,965	\$20,568
\$2,021	\$20,253	\$20,253	\$20,253	\$20,253	\$20,253	\$20,253	\$20,253	\$0	\$0	\$42,306	\$20,253
\$2,022	\$19,943	\$19,943	\$19,943	\$19,943	\$19,943	\$19,943	\$19,943	\$0	\$0	\$41,658	\$19,943
\$2,023	\$19,637	\$19,637	\$19,637	\$19,637	\$19,637	\$19,637	\$19,637	\$0	\$0	\$41,020	\$19,637
\$2,024	\$19,336	\$19,336	\$19,336	\$19,336	\$19,336	\$19,336	\$19,336	\$0	\$0	\$40,392	\$19,336
\$2,025	\$19,040	\$19,040	\$19,040	\$19,040	\$19,040	\$19,040	\$19,040	\$0	\$0	\$39,773	\$19,040
\$2,026	\$18,748	\$18,748	\$18,748	\$18,748	\$18,748	\$18,748	\$18,748	\$0	\$0	\$39,163	\$18,748
\$2,027	\$18,461	\$18,461	\$18,461	\$18,461	\$18,461	\$18,461	\$18,461	\$0	\$0	\$38,563	\$18,461
\$2,028	\$18,178	\$18,178	\$18,178	\$18,178	\$18,178	\$18,178	\$18,178	\$0	\$0	\$37,973	\$18,178
\$2,029	\$17,900	\$17,900	\$17,900	\$17,900	\$17,900	\$17,900	\$17,900	\$0	\$0	\$37,391	\$17,900
\$2,030	\$17,626	\$17,626	\$17,626	\$17,626	\$17,626	\$17,626	\$17,626	\$0	\$0	\$36,818	\$17,626
\$2,031	\$17,356	\$17,356	\$17,356	\$17,356	\$17,356	\$17,356	\$17,356	\$0	\$0	\$36,254	\$17,356
\$2,032	\$17,090	\$17,090	\$17,090	\$17,090	\$17,090	\$17,090	\$17,090	\$0	\$0	\$35,699	\$17,090
\$2,033	\$16,828	\$16,828	\$16,828	\$16,828	\$16,828	\$16,828	\$16,828	\$0	\$0	\$35,152	\$16,828
\$2,034	\$16,570	\$16,570	\$16,570	\$16,570	\$16,570	\$16,570	\$16,570	\$0	\$0	\$34,613	\$16,570
\$2,035	\$16,316	\$16,316	\$16,316	\$16,316	\$16,316	\$16,316	\$16,316	\$0	\$0	\$34,083	\$16,316
\$2,036	\$16,066	\$16,066	\$16,066	\$16,066	\$16,066	\$16,066	\$16,066	\$0	\$0	\$33,561	\$16,066
\$2,037	\$15,820	\$15,820	\$15,820	\$15,820	\$15,820	\$15,820	\$15,820	\$0	\$0	\$33,047	\$15,820
\$2,038	\$15,578	\$15,578	\$15,578	\$15,578	\$15,578	\$15,578	\$15,578	\$0	\$0	\$32,540	\$15,578
\$2,039	\$15,339	\$15,339	\$15,339	\$15,339	\$15,339	\$15,339	\$15,339	\$0	\$0	\$32,042	\$15,339
\$2,040	\$15,104	\$15,104	\$15,104	\$15,104	\$15,104	\$15,104	\$15,104	\$0	\$0	\$31,551	\$15,104
\$2,041	\$14,873	\$14,873	\$14,873	\$14,873	\$14,873	\$14,873	\$14,873	\$0	\$0	\$31,068	\$14,873
\$2,042	\$14,645	\$14,645	\$14,645	\$14,645	\$14,645	\$14,645	\$14,645	\$0	\$0	\$30,592	\$14,645
\$2,043	\$14,421	\$14,421	\$14,421	\$14,421	\$14,421	\$14,421	\$14,421	\$0	\$0	\$30,123	\$14,421
\$2,044	\$14,200	\$14,200	\$14,200	\$14,200	\$14,200	\$14,200	\$14,200	\$0	\$0	\$29,662	\$14,200
\$2,045	\$13,982	\$13,982	\$13,982	\$13,982	\$13,982	\$13,982	\$13,982	\$0	\$0	\$29,207	\$13,982
\$2,046	\$13,768	\$13,768	\$13,768	\$13,768	\$13,768	\$13,768	\$13,768	\$0	\$0	\$28,760	\$13,768
\$2,047	\$13,557	\$13,557	\$13,557	\$13,557	\$13,557	\$13,557	\$13,557	\$0	\$0	\$28,319	\$13,557
\$2,048	\$13,349	\$13,349	\$13,349	\$13,349	\$13,349	\$13,349	\$13,349	\$0	\$0	\$27,885	\$13,349
\$2,049	\$13,145	\$13,145	\$13,145	\$13,145	\$13,145	\$13,145	\$13,145	\$0	\$0	\$27,458	\$13,145
\$2,050	\$12,943	\$12,943	\$12,943	\$12,943	\$12,943	\$12,943	\$12,943	\$0	\$0	\$27,037	\$12,943
\$2,051	\$12,745	\$12,745	\$12,745	\$12,745	\$12,745	\$12,745	\$12,745	\$0	\$0	\$26,623	\$12,745
\$2,052	\$12,550	\$12,550	\$12,550	\$12,550	\$12,550	\$12,550	\$12,550	\$0	\$0	\$26,215	\$12,550
\$2,053	\$12,358	\$12,358	\$12,358	\$12,358	\$12,358	\$12,358	\$12,358	\$0	\$0	\$25,814	\$12,358
\$2,054	\$12,168	\$12,168	\$12,168	\$12,168	\$12,168	\$12,168	\$12,168	\$0	\$0	\$25,418	\$12,168
\$2,055	\$11,982	\$11,982	\$11,982	\$11,982	\$11,982	\$11,982	\$11,982	\$0	\$0	\$25,029	\$11,982
\$2,056	\$11,798	\$11,798	\$11,798	\$11,798	\$11,798	\$11,798	\$11,798	\$0	\$0	\$24,645	\$11,798
\$2,057	\$11,618	\$11,618	\$11,618	\$11,618	\$11,618	\$11,618	\$11,618	\$0	\$0	\$24,268	\$11,618
\$2,058	\$11,440	\$11,440	\$11,440	\$11,440	\$11,440	\$11,440	\$11,440	\$0	\$0	\$23,896	\$11,440
\$2,059	\$11,264	\$11,264	\$11,264	\$11,264	\$11,264	\$11,264	\$11,264	\$0	\$0	\$23,530	\$11,264
\$2,060	\$11,092	\$11,092	\$11,092	\$11,092	\$11,092	\$11,092	\$11,092	\$0	\$0	\$23,169	\$11,092
\$2,061	\$10,922	\$10,922	\$10,922	\$10,922	\$10,922	\$10,922	\$10,922	\$0	\$0	\$22,814	\$10,922
\$2,062	\$10,754	\$10,754	\$10,754	\$10,754	\$10,754	\$10,754	\$10,754	\$0	\$0	\$22,465	\$10,754
\$2,063	\$10,590	\$10,590	\$10,590	\$10,590	\$10,590	\$10,590	\$10,590	\$0	\$0	\$22,121	\$10,590
\$2,064	\$10,428	\$10,428	\$10,428	\$10,428	\$10,428	\$10,428	\$10,428	\$0	\$0	\$21,782	\$10,428
\$2,065	\$10,268	\$10,268	\$10,268	\$10,268	\$10,268	\$10,268	\$10,268	\$0	\$0	\$21,448	\$10,268
SUM	\$790,359	\$790,359	\$790,359	\$790,359	\$790,359	\$790,359	\$790,359	\$0	\$0	\$1,650,972	\$790,359

SO-04 Odour Potential

Population impacted by odour

	<u>Odor Impacts</u>		Score
	Residential Equivalents within 500 m	Cost of Odour	
Dried Fertilizer	200	\$25,000,000	3
Top Soil Blend	200	\$25,000,000	3
Mine Reclamation	200	\$25,000,000	3
Land Application	200	\$25,000,000	3
Biomass Production	200	\$25,000,000	3
Compost Product	200	\$25,000,000	3
Cement Kiln Fuel	200	\$25,000,000	3
WTE - A	200	\$25,000,000	3
WTE - B	200	\$25,000,000	3
WTE - C	220	\$27,500,000	2
WTE - D	220	\$27,500,000	2

Calculation:

Perceived Lost Value = Average Value x (# of homes + # of residential equivalent) x % reduction

Scoring:

- 1 More than \$35 million
- 2 \$25 million to \$35 million
- 3 \$15 to \$25 million
- 4 \$5 to \$15 million
- 5 Less than \$5 million

Assumptions:

	Value	Reference/basis
Average Home Value	\$500,000	per residential equivalent
Cost of odour		25% of home value

Note:

This impact represents a risk cost borne by the community

SO-06 Construction Disruption

Cost of traffic inconvenience due to construction

	<i>Disruption During Construction</i>			
	2005 Estimated Traffic Count	Estimated Construction Cost	Construction Traffic Cost	Score
Dried Fertilizer	19,750	\$254,900,000	\$20,137,100	3
Top Soil Blend	19,750	\$259,770,200	\$20,521,846	3
Mine Reclamation	19,750	\$255,344,000	\$20,172,176	3
Land Application	19,750	\$255,344,000	\$20,172,176	3
Biomass Production	19,750	\$262,717,200	\$20,754,659	3
Compost Product	19,750	\$262,902,800	\$20,769,321	3
Cement Kiln Fuel	19,750	\$254,900,000	\$20,137,100	3
WTE - A	19,750	\$270,121,000	\$21,339,559	3
WTE - B	19,750	\$292,986,000	\$23,145,894	3
WTE - C	19,750	\$252,308,000	\$19,932,332	3
WTE - D	19,750	\$265,397,000	\$20,966,363	3

Calculation:

Construction Traffic Cost = # of cars on road x (# of construction trip x % impacted) x cost of traffic

Scoring:

- 1 More than \$35 million
- 2 \$25 to \$35 million
- 3 \$15 to \$25 million
- 4 \$5 to \$15 million
- 5 Less than \$5 million

Notes:

One construction trip per \$2500 spent on construction

One existing trip impacted by one construction trip costs \$1

Probability of existing traffic impacted by plant construction is 1%

This impact represents a risk cost borne by the community

SO-07 Public and Stakeholder Acceptability

Lost time due to delay in public acceptance of end product

	<i>Public Acceptability</i>			Score
	Estimated Construction Cost	Probability of Delay	Delay Cost	
Dried Fertilizer	\$254,900,000	50%	\$15,996,098	3
Top Soil Blend	\$259,770,200	50%	\$16,301,724	3
Mine Reclamation	\$255,344,000	25%	\$8,011,980	4
Land Application	\$255,344,000	75%	\$24,035,941	2
Biomass Production	\$262,717,200	75%	\$24,729,992	2
Compost Product	\$262,902,800	50%	\$16,498,309	3
Cement Kiln Fuel	\$254,900,000	25%	\$7,998,049	4
WTE - A	\$270,121,000	75%	\$25,426,924	2
WTE - B	\$292,986,000	75%	\$27,579,243	2
WTE - C	\$252,308,000	75%	\$23,750,158	2
WTE - D	\$265,397,000	75%	\$24,982,246	2

Assumptions: Value Reference/Basis
 Delay Period 4 year

Notes:

This impact represents the risk cost associated with a potential lack of public acceptance of the end use.

Calculation:

Public Delay Cost = probability of delay x [construction cost x (1 + inflation)^ duration of delay - construction cost]

Scoring:

- 1 More than \$28 million
- 2 \$21 to \$28 million
- 3 \$14 to \$21 million
- 4 \$7 to \$14 million
- 5 Less than \$7 million

SO-08 Impacts on Future Development

Loss of value of developable land adjacent to plant

	Undeveloped land within 2 km	<i>Future Development</i>		Score
		% of Undeveloped Land Impacted	Lost Development Cost	
Dried Fertilizer	189	20%	\$7,542,000	3
Top Soil Blend	189	20%	\$7,542,000	3
Mine Reclamation	189	20%	\$7,542,000	3
Land Application	189	20%	\$7,542,000	3
Biomass Production	189	20%	\$7,542,000	3
Compost Product	189	20%	\$7,542,000	3
Cement Kiln Fuel	189	20%	\$7,542,000	3
WTE - A	189	20%	\$7,542,000	3
WTE - B	189	20%	\$7,542,000	3
WTE - C	1000	10%	\$20,000,000	1
WTE - D	1000	10%	\$20,000,000	1

Assumptions:

Developable land areas are estimates
 Cost of impact on future development \$200,000 per hectare

Note:

This impact represents a risk cost borne by the community

Calculation:

Lost Development = Area of developable land x Percentage
 Impacted x Cost of impact on development

Scoring:

- 1 More than \$15 million
- 2 \$10 to \$15 million
- 3 \$5 to \$10 million
- 4 \$0 to \$5 million
- 5 No Impact

SO-09 Loss of Beneficial Site Uses

Loss of higher or better land usage at site (measured using park land)

	Area of park or open space lost	Cost of Lost Park Land	Score
Dried Fertilizer	1.80	\$1,800,000	3
Top Soil Blend	1.80	\$1,800,000	3
Mine Reclamation	1.80	\$1,800,000	3
Land Application	1.80	\$1,800,000	3
Biomass Production	1.80	\$1,800,000	3
Compost Product	1.80	\$1,800,000	3
Cement Kiln Fuel	1.80	\$1,800,000	3
WTE - A	1.80	\$1,800,000	3
WTE - B	1.80	\$1,800,000	3
WTE - C	1.80	\$1,800,000	3
WTE - D	1.80	\$1,800,000	3

Assumptions: Value Reference/Basis
 Incremental Value of Park \$1,000,000 per hectare

Note:

This impact represents a risk cost borne by the community

Calculation:

Lost Park Cost = Area of potential park land x Incremental value of park land

Scoring:

- 1 More than \$3 million
- 2 \$2.3 to \$3 million
- 3 \$1.5 to \$2.3 million
- 4 \$700,000 to \$1.5 million
- 5 Less than \$700,000

SO-10 Compatibility with Designated Land Use

Delay due to zoning incompatibility issues

	<i>Land Compatibility Impact</i>			Score
	Construction Cost	Delay Due to Rezoning	Rezoning Cost	
Dried Fertilizer	\$254,900,000	0.50	\$3,795,246	3
Top Soil Blend	\$259,770,200	0.50	\$3,867,759	3
Mine Reclamation	\$255,344,000	0.50	\$3,801,857	3
Land Application	\$255,344,000	0.50	\$3,801,857	3
Biomass Production	\$262,717,200	0.50	\$3,911,638	3
Compost Product	\$262,902,800	0.50	\$3,914,401	3
Cement Kiln Fuel	\$254,900,000	0.50	\$3,795,246	3
WTE - A	\$270,121,000	0.50	\$4,021,874	3
WTE - B	\$292,986,000	0.50	\$4,362,314	3
WTE - C	\$252,308,000	0.50	\$3,756,653	3
WTE - D	\$265,397,000	0.50	\$3,951,537	3

Calculation:

Rezoning Cost = construction cost x (1 + inflation)^ duration of delay

Scoring:

- 1 More than \$7 million
- 2 \$5 to \$7 million
- 3 \$3 to \$5 million
- 4 \$1 to \$3 million
- 5 Less than \$1 million

Note:

This impact represents a risk cost associated with a delay due to the rezoning process

SO-11 Cultural Resource Impacts
Risk cost of a cultural site find

	<i>Cultural Resources Impact</i>			Score	
	Estimated Construction Cost	Delay caused by cultural find	Probability of a cultural find		Cost of Cultural Find
Dried Fertilizer	\$254,900,000	1.0	5%	\$382,350	3
Top Soil Blend	\$259,770,200	1.0	5%	\$389,655	3
Mine Reclamation	\$255,344,000	1.0	5%	\$383,016	3
Land Application	\$255,344,000	1.0	5%	\$383,016	3
Biomass Production	\$262,717,200	1.0	5%	\$394,076	3
Compost Product	\$262,902,800	1.0	5%	\$394,354	3
Cement Kiln Fuel	\$254,900,000	1.0	5%	\$382,350	3
WTE - A	\$270,121,000	1.0	5%	\$405,182	3
WTE - B	\$292,986,000	1.0	5%	\$439,479	3
WTE - C	\$252,308,000	1.0	5%	\$378,462	3
WTE - D	\$265,397,000	1.0	5%	\$398,096	3

Calculation:

Cultural Resources Impact = probability of a cultural find x construction cost x (1 + inflation)^ duration of delay

Scoring:

- 1 More than \$700,000
- 2 \$500,000 to \$700,000
- 3 \$300,000 to \$500,000
- 4 \$100,000 to \$300,000
- 5 Less than \$100,000

Notes:

This impact represents the risk cost associated with a cultural resource find during construction.

Appendix B Supplemental Evaluation of WTE Phasing Options

One potential alternative to the waste-to-energy (WTE) facility at the Hartland landfill is to build out the facility capacity in phases. Modular burn units would be installed sequentially until the final capacity is achieved. This would avoid an up-front commitment of capital cost for the entire WTE facility and allow time for the biosolids land application programs to develop. The first phase of this alternative and the impacts to capital costs, operating and maintenance (O&M) costs, and greenhouse gas (GHG) emissions are considered here.

The first-phase capacity of the WTE would be significantly smaller than the final capacity. The WTE facility at the Hartland landfill would be expected to have a final capacity to incinerate 210,000 tonnes per year (tpy) of biosolids and residual (post-diversion) municipal solid waste (MSW). The first-phase capacity is assumed to be 90 tonnes per day (tpd) or 33,000 tpy which would more than accommodate the 14-day peak biosolids load with digestion.

The biosolids would only use part of the WTE facility capacity and the remaining capacity would be utilized by burning residual MSW. The capacity available for burning MSW is shown in **Table B.1**. The residual MSW sent to the WTE facility would be material remaining after removing recyclable materials from the MSW.

Table B.1 – First-Phase Facility WTE Capacities

Total Capacity, tpy	Average Biosolids, tpy	Average MSW, tpy
33,000	6,100	26,900

The combustion of the residual MSW sent to the WTE facility would create new GHG emissions and avoid other GHG emissions. The electricity that would be produced would avoid emissions from electricity that would otherwise be produced by the utility for the local area to the Hartland landfill, thus reducing GHG emissions. In addition, the fugitive CH₄ and CO₂ emissions that would otherwise be released after anaerobic digestion of the residual MSW (e.g., paper, textiles, etc.) in the landfill would be avoided. The combustion of this material would produce GHG emissions from the fossil-based materials in the residual MSW (e.g., plastics, rubber, etc.) and emissions from the materials required for the WTE process (e.g., lime, ammonia, etc.). The net result of GHG emissions to combust the residual MSW is a net decrease as listed in **Table B.2**. The GHG analysis data from Section 8 for the entire biosolids facility for this option are also listed in **Table B.2**.

CAPITAL REGIONAL DISTRICT

Core Area Wastewater Treatment Program
 Biosolids Management Plan

Table B.2 – Greenhouse Gas Emissions and Electricity Production for Residual MSW Combustion and Biosolids Facility

	MSW Only ¹	Total Biosolids Facility (without MSW) ²	Total Biosolids and MSW	Quantity
Net electricity produced	20,600	6,500	27,100	MWh/yr
GHG emissions produced ³	5,000	2,800	7,800	tonne CO ₂ e/yr
GHG emissions avoided, total	-8,900	-7,800	-16,700	tonne CO ₂ e/yr
Electricity production offset ⁴	-1,800			tonne CO ₂ e/yr
Metal recovery offset	-1,300			tonne CO ₂ e/yr
Landfill avoidance offset ⁵	-5,800			tonne CO ₂ e/yr
Net GHG	-3,900	-5,000	-8,900	tonne CO ₂ e/yr

Notes:

1. Calculations based on input waste composition from study produced for Durham York with a similar waste diversion program (ref. Durham-York Report, 2009).
2. GHG emissions include the entire biosolids facility for digestion and WTE at Hartland landfill to incinerate biosolids. These data can be found in Section 8.
3. Direct emissions from combustion of fossil fuel based constituents.
4. Assumes grid power from British Columbia power sources.
5. Avoided emissions for land filling the MSW with a 60% landfill gas capture.

The capital costs for a first-phase WTE facility would be much smaller as compared to a WTE facility of final capacity. The total capital costs including the WTE facility are reduced by about 31%. However, the WTE facility would be significantly more expensive on a per capacity basis. The higher cost relative to capacity is attributed to economies of scale. The difference in capital costs for the full capacity system and a first phase capacity system are shown in **Table B.3**.

CAPITAL REGIONAL DISTRICTCore Area Wastewater Treatment Program
Biosolids Management Plan**Table B.3 – Biosolids Treatment Facility Capital Costs with Phased Capacity**

	Digested Sludge with MSW at Hartland	Digested Sludge with MSW at Hartland with Phased Capacity
Biosolids Treatment Facility Capital Costs		
Civil/site work	\$9,800,000	\$9,800,000
Yard piping	\$7,500,000	\$7,500,000
Anaerobic digestion	\$28,600,000	\$28,600,000
Dewatering	\$23,500,000	\$23,500,000
Dryers	\$19,900,000	\$19,900,000
Odour control	\$600,000	\$600,000
Energy building/heat extraction and recovery	\$4,400,000	\$4,400,000
Gas scrubbing	\$8,200,000	\$8,200,000
Gas flares	\$1,300,000	\$1,300,000
Biofilter	\$6,700,000	\$6,700,000
Sludge screening	\$3,300,000	\$3,300,000
Electrical and instrumentation	\$17,800,000	\$17,800,000
Fog receiving/sludge blend tanks	\$9,200,000	\$9,200,000
Direct Construction Costs		
Construction costs	\$140,800,000	\$140,800,000
Design contingency (10% of construction costs)	\$14,100,000	\$14,100,000
Construction contingency (15% of construction costs)	\$21,100,000	\$21,100,000
Total Direct Costs	\$176,000,000	\$176,000,000
Indirect Costs		
Engineering (15% of direct costs)	\$26,400,000	\$26,400,000
Administration (3% of direct costs)	\$5,300,000	\$5,300,000
Miscellaneous (2% of direct costs)	\$3,500,000	\$3,500,000
Total Indirect Costs	\$35,200,000	\$35,200,000

Table B.3 – Biosolids Treatment Facility Capital Costs with Phased Capacity

	Digested Sludge with MSW at Hartland	Digested Sludge with MSW at Hartland with Phased Capacity
Subtotal (Direct and Indirect Costs)	\$211,200,000	\$211,200,000
Interim financing (4% of Subtotal)	\$8,400,000	\$8,400,000
Inflation to midpoint of construction: 2014 (2% per annum)	\$27,500,000	\$27,500,000
Total Capital Costs	\$247,100,000	\$247,100,000
WTE Facility Capital Costs¹		
WTE facility total capital costs including MSW	\$195,400,000	\$58,400,000
WTE costs for biosolids only	\$18,300,000 ^{2,3}	\$30,400,000 ^{3,4}
Total Capital Costs Including MSW	\$442,500,000	\$305,500,000
Total Capital Costs for Biosolids Only	\$265,400,000	\$277,500,000

Notes:

1. Costs for WTE facilities are installed costs. The WTE facility includes incinerator, energy recovery system, emissions treatment equipment, etc.
2. The mass burn facility is sized for a capacity of 200,000 tonnes/year. The biosolids portion of the mass burn facility was determined for peak 14-day solids load and 50% cake. The cost of the WTE facility is displayed as a fraction of the total costs based on the ratio of biosolids to MSW. An additional 25% capital costs was added to account for dried biosolids handling, feeding, and monitoring equipment at the WTE facility.
3. WTE facility at Hartland includes markup of installed capital cost for administration and interim financing (total markup 7%).
4. The mass burn facility is sized for a capacity of 33,000 tonnes/year with solids handling and post combustion gas scrubbing for full capacity. The biosolids portion of the mass burn facility was determined for peak 14-day solids load and 50% cake. The cost of the WTE facility is displayed as a fraction of the total costs based on the ratio of biosolids to MSW.

The O&M costs for the WTE facility would also increase on a per capacity basis. Similar to the capital costs, economies of scale dictate that the O&M costs would increase on a per capacity basis. The operators attributed to the biosolids portion of the WTE facility would remain the same. The difference in O&M costs for the full capacity system and a first phase capacity system are shown in **Table B.4**.

CAPITAL REGIONAL DISTRICT

Core Area Wastewater Treatment Program
Biosolids Management Plan

Table B. 4–Biosolids Treatment Facility O&M Costs with Phased Capacity

	Digested Sludge with MSW at Hartland	Digested Sludge with MSW at Hartland with Phased Capacity
Biosolids Treatment Facility		
Operating costs for biosolids treatment		
Power costs ¹	\$2,100,000	\$2,100,000
Chemical costs ²	\$700,000	\$700,000
Water costs ³	\$100,000	\$100,000
Operating labour for biosolids treatment		
Chief operator ⁵	2	2
Operator ⁶	4	4
Labourer ⁷	3	3
Total Operating Labour Costs for Biosolids Treatment	\$670,000	\$670,000
Maintenance Costs for Biosolids Treatment ⁸	\$2,700,000	\$2,700,000
Waste-to-Energy (WTE)		
Operating costs for WTE ⁹	\$300,000	\$300,000
Operating labour for WTE		
Chief operator ⁴	0	0
Operator ⁵	2	2
Labourer ⁶	2	2
Total Operating Labour for WTE	\$300,000	\$300,000
Maintenance Costs for WTE ⁸	\$200,000	\$300,000
Total Costs		
Total operating costs (biosolids and WTE)	\$4,200,000	\$4,200,000
Total maintenance costs (biosolids and WTE)	\$2,900,000	\$3,000,000
Total O&M costs	\$7,100,000	\$7,200,000

Notes:

1. Power costs assume a unit cost of \$0.08/kWh.
2. Chemical costs consist of polymer for dewatering at \$4.50/kg polymer.
3. Water costs assume a unit cost of \$700/ML.
4. Chief operator assumed to cost \$100,000/year.
5. Operator assumed to cost \$80,000/year.
6. Labourer assumed to cost \$50,000/year.
7. Maintenance costs estimated at 1.1% of capital costs.
8. Operating cost of mass burn facility assumes a unit cost of \$85/DT and \$95/DT less the labour costs for the 200,000-tpy and 33,000-tpy facilities, respectively. These values include consumables, equipment repair/refurbishment, auxiliary fuel, utilities, power, administration, insurance, and taxes.

CAPITAL REGIONAL DISTRICT

Core Area Wastewater Treatment Program
Biosolids Management Plan

Revenues attributed to the biosolids portion of the WTE facility would not change. While the smaller WTE facility would likely have a lower electrical conversion efficiency, the difference in electricity production is assumed to be negligible.

A TBL evaluation was done for the first-phase WTE facility with biosolids only and including MSW. The results are shown in **Table B.5** along with the full capacity WTE results (with biosolids only) from Section 10. The same information is illustrated graphically in **Figure B.1**.

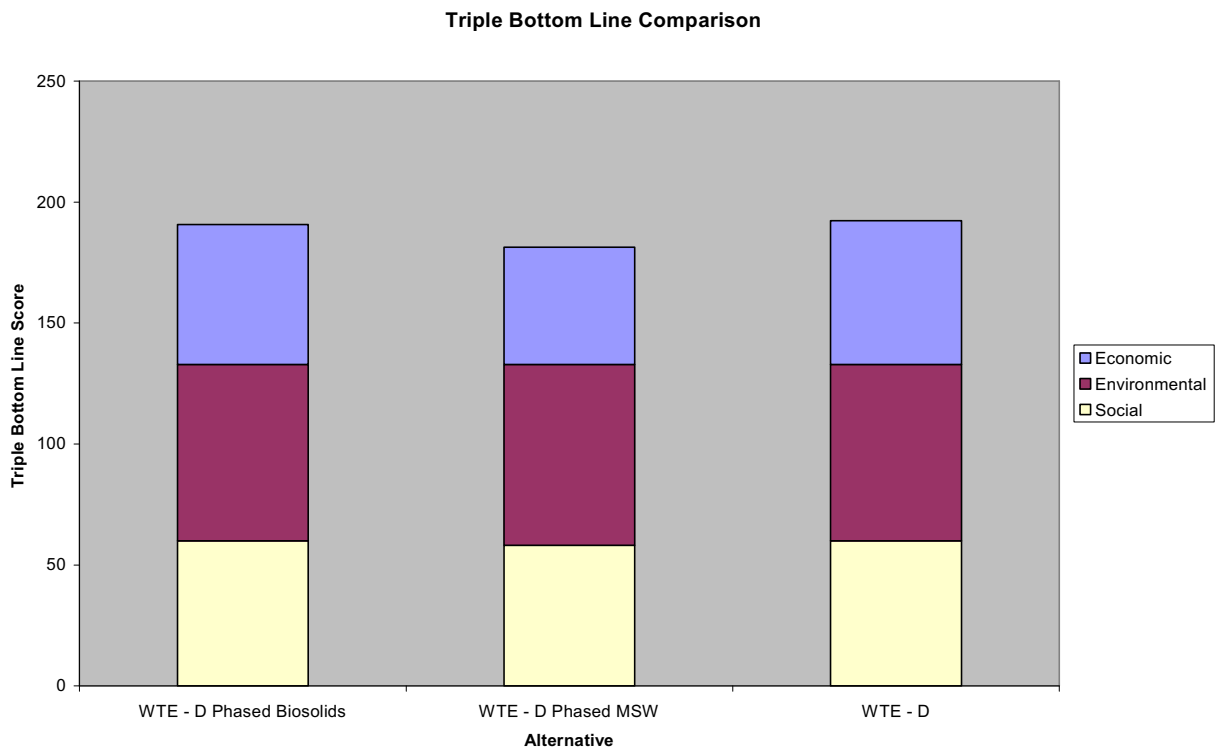

Figure B.1 – Graphical Results of TBL Analysis

The results of scoring the Economic criteria for each alternative are as follows:

Offsite WTE (digested) Only Biosolids:	59
Offsite WTE (digested) First Phase Only Biosolids:	58
Offsite WTE (digested) First Phase with MSW:	48

The larger capital and O&M costs for the first-phase WTE with MSW costs included made its Economic score significantly worse than either of the options where only the biosolids portion of the WTE facility are considered.

CAPITAL REGIONAL DISTRICT

Core Area Wastewater Treatment Program
Biosolids Management Plan

The results of scoring the Environmental criteria for each alternative are as follows:

Offsite WTE (digested) Only Biosolids:	73
Offsite WTE (digested) First Phase Only Biosolids:	73
Offsite WTE (digested) First Phase with MSW:	75

The first-phase WTE including MSW has a better carbon equivalent avoidance and a greater electricity production thus giving it a slight advantage in the Environmental criteria. However, the emissions from transporting the MSW were not included since this information was unavailable. The transportation emissions would tend to reduce the Environmental score for WTE including MSW.

The results of scoring the Social criteria for each alternative are as follows:

Offsite WTE (digested) Only Biosolids:	60
Offsite WTE (digested) First Phase Only Biosolids:	60
Offsite WTE (digested) First Phase with MSW:	58

The first-phase WTE including MSW has a slightly lower Social criteria score because of the greater number of traffic delays associated with the construction.

When the three criteria groups are summed, the resulting TBL scores for the 3 alternatives are as follows:

Offsite WTE (digested) Only Biosolids:	192
Offsite WTE (digested) First Phase Only Biosolids:	191
Offsite WTE (digested) First Phase with MSW:	181

The TBL analysis ranks the full capacity WTE facility with biosolids only higher when compared to the phased approach or when considering MSW into the TBL for the WTE facility at the Hartland Landfill.

CAPITAL REGIONAL DISTRICT

Core Area Wastewater Treatment Program
Biosolids Management Plan

Table B.5 – Summary Table of TBL Analysis Results

Criteria Group	No.	Criteria Categories	Measure Description	Weight	WTE - D Phased Biosolids	WTE - D Phased MSW	WTE - D	Comments
Economic	EC-01	Capital Costs	construction cost and markup for soft costs adjusted to midpoint of construction	8	2.7	2.5	2.8	Costs included for resource recovery systems
	EC-02	Capital Costs Eligible for Grants	Not available at this time	-	-	-	-	
	EC-03	Tax Revenue Implications	cost of private property lost and lost revenue from reduced property values	1	3	3	3	
	EC-04	Present Worth of O&M costs	O&M costs	8	2.9	2.0	3.0	Costs included for resource recovery systems
	EC-05	Flexibility for Future Treatment Process Optimization	cost of additional tankage needed for process optimization	1	3.0	3.0	3.0	
	EC-06	Expandability for Population Increases	additional space needed versus available to meet 2065 loading	1	3.0	3.0	3.0	
	EC-07	Flexibility to Accommodate Future Regulations	additional space needed versus available to meet potential regulations	1	4.0	4.0	4.0	
Economic Subtotal (100 pts max)¹:					57.9	48.5	59.45	
Environmental	EN-01	Carbon Footprint	tons of eCO2 created	1.82	3.0	4.0	3.0	
	EN-02	Heat Recovery Potential	Heat energy replacing natural gas	1.82	4.0	4.0	4.0	
	EN-03	Water Reuse Potential	not applicable to this analysis	-	-	-	-	
	EN-04	Biomethane Resource Recovery	Recovery of biomethane resources	1.82	5.0	5.0	5.0	
	EN-05	Power (energy) usage or generation	kilowatt hours per year consumed	1.82	3.0	4.0	3.0	Cost also included in EC-04
	EN-06	Transmission Reliability	risk cost of transmission failure	1.82	5.0	5.0	5.0	
	EN-07	Site Remediation	risk cost of site remediation	1.82	3.0	3.0	3.0	
	EN-08	Pollution Discharge	air emissions discharged	1.82	3.0	2.0	3.0	
	EN-09	Non-renewable Resource Use	Gallons of diesel consumed per year	1.82	3.0	3.0	3.0	Cost also included in EC-04
	EN-10	Non-renewable Resource Generated	Biosolids production	1.82	3.0	3.0	3.0	
	EN-11	Flexibility for Future Resource Recovery	Additional space needed to add 100% additional resource recovery	1.82	3.0	3.0	3.0	
	EN-12	Terrestrial and Inter-tidal Effect	Habitat areas potentially disturbed	1.82	5.0	5.0	5.0	
Environmental Subtotal (100 pts max):					72.8	74.6	72.8	
Social	SO-01	Impact on Property Values	Lost value to present community	1.82	4.0	4.0	4.0	
	SO-02	Operations Traffic in Sensitive Areas	Cost of traffic inconvenience during operations	1.82	4.0	4.0	4.0	
	SO-03	Operations Noise in Sensitive Areas	Cost of noise inconvenience	1.82	4.0	4.0	4.0	
	SO-04	Odour Potential	Cost of odour issues	1.82	2.0	2.0	2.0	
	SO-05	Visual Impacts	Perceived value of lost view	1.82	4.0	4.0	4.0	
	SO-06	Construction Disruption	Cost of traffic inconvenience due to construction	1.82	3.0	3.0	3.0	
	SO-07	Public and Stakeholder Acceptability	Lost time due to public disapproval	1.82	2.0	1.0	2.0	
	SO-08	Impacts on Future Development	Loss of value of developable land adjacent to facility	1.82	1.0	1.0	1.0	
	SO-09	Loss of Beneficial Site Uses	Loss of park land due to facility	1.82	3.0	3.0	3.0	
	SO-10	Compatibility with Designated Land Use	Delay due to zoning changes	1.82	3.0	3.0	3.0	
	SO-11	Cultural Resource Impacts	Risk cost of a cultural site find	1.82	3.0	3.0	3.0	
Social Subtotal (100 pts max):					60.1	58.2	60.1	
TOTAL SCORE (300 pts max):					190.7	181.3	192.3	

1 - Economic weighting is proportional to NPV results

CAPITAL REGIONAL DISTRICT

Core Area Wastewater Treatment Program
Biosolids Management Plan

REFERENCES

Durham York, Facility Energy and Life Cycle Assessment – Technical Study Report, Report No. MA-06-512-30-MA, July 31, 2009.